

*Model 2090 Series*  
Multi-Device  
Controller  
MANUAL



ETS-Lindgren reserves the right to make changes to any products herein to improve functioning or design. Although the information in this document has been carefully reviewed and is believed to be reliable, ETS-Lindgren does not assume any liability arising out of the application or use of any product or circuit described herein; nor does it convey any license under its patent rights nor the rights of others.

©Copyright 2006 by ETS-Lindgren L.P. All Rights Reserved.  
 No part of this document may be copied by any means  
 without written permission from ETS-Lindgren L.P.

<b>Revision</b>	<b>Description</b>	<b>Date</b>
A	Initial Release	December, 1995
B	Revision	February, 1996
C	Revision	April, 1997
D	Revision	October, 1997
E	Revision	January, 1998
F	Revision	April, 2001
G	Add Option 1 Section. Update warranty and template to current standards.	April, 2006

<b>E-Mail &amp; Internet Addresses</b> <a href="mailto:support@ets-lindgren.com">support@ets-lindgren.com</a> <a href="http://www.ets-lindgren.com">http://www.ets-lindgren.com</a>
<b>USA</b> 1301 Arrow Point Drive Cedar Park, TX 78613 USA Tel. +1.512.531.6400 Fax +1.512.531-6500
<b>Finland</b> Mekaanikontie 1, 27510, Eura, Finland Tel. +358.2.838.330 Fax +358.2.865.1233
<b>Japan</b> 4-2-6, Kohinata Bunkyo-ku, Tokyo 112-0006 Japan Tel. +81.3.3813.7100 Fax +81.3.3813.8068
<b>China</b> 1917-1918 Xue Zhixuan Building No. 16 Xue Qing Road Haidian District Beijing Postcode: 100083 China Tel. +86.010.827.55304 Fax +86.010.827.55307

# TABLE OF CONTENTS

MODEL 2090 QUICK REFERENCE .....	7
KEYBOARD NAVIGATION .....	9
INTRODUCTION.....	11
APPLICATIONS.....	12
FEATURES .....	13
STANDARD CONFIGURATION.....	16
OPTIONAL FEATURES.....	17
PREPARATION FOR USE .....	19
UNPACKING THE CONTROLLER .....	19
FRONT PANEL DESCRIPTION.....	20
STANDARD BACK PANEL DESCRIPTION .....	29
OPTIONAL BACK PANEL DESCRIPTION.....	31
POWER REQUIREMENTS .....	32
RACK MOUNTING.....	33
DEVICE CONNECTIONS .....	33
OPTIONAL DEVICE CONNECTIONS.....	35
GPIB INTERCONNECTIONS .....	36
INITIALIZATION .....	37
STARTUP .....	37
EDITING PARAMETERS .....	40
CONFIGURING FOR USE.....	43
MODEL 2090 PARAMETER LIST .....	45
OPERATION .....	55
MANUAL OPERATIONS .....	55
USING LOCAL FUNCTIONS .....	56
USING POSITION FUNCTIONS .....	56
USING LIMIT FUNCTIONS .....	58
USING THE SCAN FUNCTION.....	59
USING THE STEP FUNCTIONS .....	60
CHANGING POLARIZATION.....	60
POLARIZATION VIOLATION AND LIMITS.....	63
CHANGING SPEEDS.....	63
USING AUXILIARY CONTROL FUNCTIONS .....	66
USING A BORE SIGHT TOWER.....	67
USING AN AIR FLOTATION TURNTABLE .....	69
USING A REVERBERATION PADDLE.....	69
USING A MULTI-AXIS POSITIONER .....	70
REMOTE OPERATIONS .....	71
USING THE GPIB COMMAND SET WITH THE MODEL 2090.....	73
BACKWARD COMPATIBILITY.....	73
GETTING STARTED WITH THE GPIB .....	74
TYPICAL FLOW OF CODE:.....	75
CODE SAMPLE 1 .....	76
CODE SAMPLE 2 .....	77
GPIB STATUS REPORTING .....	82
APPENDIX A: MODEL 2090 GPIB COMMAND REFERENCE .....	97
LIST OF MODEL 2090 GPIB COMMANDS.....	98
ALPHABETICAL LIST OF MODEL 2090 GPIB COMMANDS .....	101
APPENDIX B: MAINTENANCE .....	137
NVRAM BATTERY BACKUP.....	137
INSTALLING FLASH ROMS.....	140
FLASH UPGRADING THE MODEL 2090.....	147

FLASH UPGRADING MOTOR BASES ..... 150  
APPENDIX C: MODEL 2090 ERROR CODE REFERENCE..... 157  
    ERROR CODES ..... 157  
    TROUBLESHOOTING ERROR CODES ..... 158  
APPENDIX D: PARAMETER SETTINGS ..... 165  
    PARAMETER SETTING FOR AMS-8050 AND 2188 SERIES MAPS ..... 165  
WARRANTY STATEMENT: ..... 167  
TECHNICAL SUPPORT ..... 173  
EUROPEAN COMMUNITY DECLARATION OF CONFORMITY ..... 175  
INDEX..... 177

# FIGURES

---

---

Figure 1 Model 2090 Front Panel .....	20
Figure 2 Model 2090 Device Control Block .....	21
Figure 3 Model 2090 Standard Back Panel.....	29
Figure 4 Model 2090 Option 1 Back Panel.....	31
Figure 5 Bore sight geometry for standard bore sight tower .....	68
Figure 6 Status Reporting Model.....	83
Figure 7 Model 2090 Motherboard.....	139
Figure 8 Universal Device Controller Upgrade Utility .....	149
Figure 9 MB-V Flash Upgrade Utility .....	153

**NOTICE** : This product and related documentation must be reviewed for familiarization with safety markings and instructions before operation.

**SAFETY SYMBOL DEFINITIONS**

		<p><b>REFER TO MANUAL</b> When product is marked with this symbol refer to instruction manual for additional information.</p>
		<p><b>HIGH VOLTAGE</b> Indicates the presence of hazardous voltage. Unsafe practices could result in severe personal injury or death.</p>
		<p><b>PROTECTIVE EARTH GROUND (SAFETY GROUND)</b> Indicates protective earth terminal. You should provide an uninterruptible safety earth ground from the main power source to the product input wiring terminals, power cord, or supplied power cord set.</p>
		<p><b>CAUTION</b> Denotes a hazard. Failure to follow instructions could result in minor personal injury and/or property damage. Included text gives proper procedures.</p>

**GENERAL SAFETY CONSIDERATIONS**

		<p><b>BEFORE POWER IS APPLIED TO THIS INSTRUMENT, GROUND IT PROPERLY</b> through the protective conductor of the AC power cable to a power source provided with protective earth contact. Any interruption of the protective (grounding) conductor, inside or outside the instrument, or disconnection of the protective earth terminal could result in personal injury.</p>
		<p><b>BEFORE SERVICING: CONTACT EMC TEST SYSTEMS</b> – servicing (or modifying) the unit by yourself may void your warranty. If you attempt to service the unity by yourself, disconnect all electrical power before starting. There are voltages at many points in the instrument which could, if contacted cause personal injury. Only trained service personnel should perform adjustments and/or service procedures upon this instrument. <b>Capacitors inside this instrument may still be CHARGED even when the instrument is disconnected from its power source.</b></p>
	<p>FUSE 2 A; 250 V T</p>	<p><b>TO AVOID A SAFETY HAZARD</b>, replace fuses with the same current rating and type (normal blow, time delay, etc.). Order any replacement parts direct from ETS.</p>
		<p><b>TO AVOID UNDUE MECHANICAL STRESS</b> on the GPIB I/O CONNECTOR, limit connector stacking to no more than three cables on one connector.</p>
		<p><b>ONLY QUALIFIED PERSONEL</b> should operate (or service) this equipment.</p>
		<p><b>IN EVENT OF EMERGENCY</b> push the Model 2090 STOP button and power unit down.</p>

# MODEL 2090 QUICK REFERENCE

---

## Error List

<i>E001</i>	<b>NVM Initialization Error</b> – Parameters restored to factory defaults due to dead battery.
<i>E002</i>	<b>Motor not moving</b> – Device stalled due to overload, power problems, or failure.
<i>E003</i>	<b>Device will not stop</b> – Device continued moving for too long after motion was disabled.
<i>E004</i>	<b>Device moving wrong direction</b> – Device wired wrong, failing, or reverse delay too short.
<i>E005</i>	<b>Hard Limit hit</b> – Device has reached a mechanical limit.
<i>E006</i>	<b>Polarization limits violation</b> – Tower polarized outside allowed target polarization limits.
<i>E007</i>	<b>Communication lost</b> – No comm. w/ device; power off, fiber disconnected, or failure.
<i>E008</i>	<b>Flotation violation</b> – Attempt to disengage air flotation while turntable is in motion.
<i>E009</i>	<b>Encoder failure</b> – Detected changes in position consistent with an encoder problem.
<i>E010</i>	<b>Trigger failure</b>
<i>E011</i>	<b>Overheat Error</b> – Motor or control board over temperature
<i>E012</i>	<b>Relay Failure</b> – Motor drive control relays not switching properly
<i>E100</i>	<b>ROM test error</b> – ROM has been detected as being corrupt.
<i>E101</i>	<b>RAM test error</b> – RAM has been detected as being corrupt.
<i>E102</i>	<b>NVM test error</b> – NVM has been detected as being corrupt.
<i>E103</i>	<b>Low Power test error</b> – Power test failed.
<i>E104</i>	<b>GPIB test error</b> – GPIB test failed.
<i>E996</i>	<b>BERR Error</b>
<i>E997</i>	<b>Uninitialized Interrupt</b>
<i>E998</i>	<b>Spurious Interrupt</b>
<i>E999</i>	<b>Invalid Interrupt Error</b>

Errors less than *E100* can be cleared by pressing any key on the front panel to acknowledge the error. The cause of the error condition should be corrected before continuing. The remaining errors may indicate that the 2090 requires service. If one of these errors occurs, power off the unit for several seconds and power it back on. If the error recurs, contact EMC Test Systems, L.P. for service.

## Parameter List

P1	<b>Device Type:</b> (0 = rotational positioner, 1 = linear positioner)
P2	<b>Device Sub-Type:</b> (0 = Standard Turntable/Tower, 1 = Air Flotation Turntable/Bore Sight Tower, 2 = Two Speed Turntable)
P3	<b>SCAN cycle count:</b> (1-999 complete scans, 0 = infinite scan)
P4	<b>Polarization offset:</b> ( $\pm 50$ cm) -or- <b>Bore Sight separation distance:</b> (3, 10, or 30 m)
P5	<b>Bore sight correction table:</b> (0 = standard, 1 = alternate) -or- <b>Turntable rotation mode:</b> (0 = Continuous, 1 = Non-continuous)
P8	<b>Motor reverse delay:</b> (0.1 – 99.9 seconds)
P9	<b>GPIB Address:</b> (0-30)
B1	<b>Bit 0, STEP limits</b> – (0 = INC/DEC limited by hard limits, 1 = INC/DEC limited by soft limits) <b>Bit 1, Quick Stop</b> – (0 = normal deceleration, 1 = fast deceleration (variable speed only))
C	<b>Encoder calibration:</b> Encoder counts per meter/revolution (1-9999). Typical values are: Towers: Default = 2000, 2075 = 1620; Turntables: Default = 3600, 2065 = 3665, 2081 = 3608, 2088 = 4500 (4800*), 5901 = 6000 (6400*), MAPS = 4500. * Early revisions.
S0	<b>STEP speed setting:</b> (-1 = disabled, 0-255 (variable speed devices only)
S1-S8	<b>Speed setting:</b> (0-255 (variable speed devices only)
PCLr	<b>Clear Parameters:</b> Restores this device to factory default.
OSCLr	<b>Clear Overshoot:</b> Clears overshoot compensation values for this device.
OE	<b>Overshoot Compensation Enable/Disable:</b> (ON = enabled, OFF = disabled)
ZEAD	<b>Zero Reference :</b> Initiates a zero pulse reference scan on equipped devices.
BASE	<b>Motor base firmware revision:</b> For informational purposes only.
ACC	<b>Acceleration:</b> Time in seconds for motorbase to reach full speed (variable speed devices only)
tEt P	<b>Temperature monitor:</b> Displays motor and control board temperature.
Snd	<b>Motorbase sound setting:</b> (0 = No sounds, 1 = remote control only, 2 = errors enabled, 3 = all sounds enabled).



# KEYBOARD NAVIGATION

---

**To return to local operation** – when RMT indicator lit, pressing LOCAL restores local operation.

**To initiate/stop motion** – press UP/CW or DOWN/CCW under POSITION to start motion. Press SCAN to toggle scan mode on or off. Press and hold INC or DEC keys under STEP, when the display shows the current position, to initiate motion while the key is pressed. Press STOP under POSITION to stop motion.

**To change mast polarization** – press the POLARIZATION/FLOAT/SPEED button under POSITION, while the display shows the current position, to toggle the polarization. Polarizing the tower while the boom is above or below the limits of the target polarization will cause an error E006.

**To change air flotation turntable flotation** – press the POLARIZATION/FLOAT/SPEED button under POSITION to toggle the flotation. Deflating the table while in motion will cause an error E008.

**To change speed selection** – on a variable speed device, press the LOCAL key while in local mode and viewing the current position to display the current speed selection. Press INCRM and DECRM under LIMIT to scroll up or down through the available speeds. For variable speed turntables, press the POLARIZATION/FLOAT/SPEED button under POSITION to scroll through the available speeds. For two-speed turntables, press the POLARIZATION/FLOAT/SPEED button under POSITION to toggle between high and low speeds.

**To view limits** – press UP/CW, DOWN/CCW, or CURRENT POSITION under LIMIT to display the associated value.

**To view limits for the opposite polarization** – with the desired limit displayed, press the POLARIZATION/FLOAT/SPEED button under POSITION. The tower will remain at the current polarization, but the display will change to the limit for the other polarization. The POLARIZATION indicator will flash to indicate that the display does not represent the actual state of the device.

**To view parameters** – press PARAM under CONFIG to display the current parameter. Repeatedly pressing PARAM will scroll through the parameter list. While a parameter is displayed, pressing INC or DEC under STEP will scroll up or down through the available parameters.

**To edit limits or parameters** – with the desired limit, position, or parameter visible in the display, press ENTER under LIMIT to enter edit mode. Pressing INCRM or DECRM under LIMIT will also enter edit mode and immediately change the first digit. The active digit will flash, and pressing INCRM or DECRM will increase or decrease that value. For values with multiple digits, pressing the LOCAL key while the display is flashing will shift to the next higher digit in the display. Once the desired value is entered into the display, press ENTER to store the data. Pressing any other non-edit key will exit the edit mode, discarding the value, and activate the associated function. For parameter function calls (PCLr, OSCLr, & ZERO), pressing ENTER will ask for confirmation (SURE). Pressing enter again will activate the function.

**To use auxiliary devices** – press the 1-4 button under AUX CONTROL to toggle the associated auxiliary port on or off.

This page intentionally left blank.

# INTRODUCTION

---

---

The Model 2090 Multi-Device Positioning Controller is designed for use with ETS-Lindgren positioning devices such as antenna towers, turntables, reverberation paddles, multi-axis positioners, etc. to accomplish a variety of tests for EMC compliance, antenna pattern measurements, and more.

The Controller allows the user to synchronize the simultaneous, yet independent movement of two primary devices such as towers or turntables in either manual or remote GPIB modes while controlling the on/off operation of up to four auxiliary devices.

Each primary device is interfaced to the Model 2090 through a bi-directional fiber optic interface using a proprietary command protocol. Auxiliary devices use a single-pole double-throw RF relay to control simple on/off operation. The connection type is SMA.

The front panel of the Model 2090 provides the interface for two separate and complete device controllers, each with identical displays and function keys. The function keys let the user configure device specific parameters, adjust limit and position settings, and control device motion. Numeric displays and status indicators are provided for each device interface to show positioning and operational information, as well as device parameter settings. In addition to the two primary device interfaces, there is an auxiliary control interface for four auxiliary devices. This interface provides

keys and indicators to allow the user to manually toggle the auxiliary devices on or off.

Control of all devices may be accomplished either in the manual or remote modes through the use of the GPIB (IEEE 488 standard interface bus) port located on the rear panel. Each primary device is identified by a unique GPIB address that the controller recognizes, allowing each positioning device to function as a separate device on the GPIB bus.

## APPLICATIONS

---

### **RADIATED EMISSIONS TESTING**

The Model 2090 is used to control ETS-Lindgren towers and turntables during manual or fully automated radiated emissions testing. The controller is capable of controlling the tower height scan and antenna polarization functions and the turntable rotation function from the operator's station during remotely controlled or manual measurements. This capability satisfies the technical measurement requirement to search in azimuth and over a specified height range to detect the maximum of the signal sourced in the equipment under test.

### **SITE ATTENUATION MEASUREMENTS**

The Model 2090 allows for the remote control of the height search of all ETS-Lindgren towers during site attenuation testing. With this capability, the user can maximize the signal level detected at each measurement frequency within the required height search range.

### **PATTERN ANALYSIS**

With the Model 2090, the user can have manual or automated control of the turntable rotation function or the ortho (elevation) and azimuth functions of a Multi-Axis Positioning System (MAPS) from an operator's station during antenna pattern measurement.

### **REVERBERATION CHAMBERS**

The Model 2090 can provide precise step control of all ETS-Lindgren reverberation paddles for mode-tuned operation, or continuous rotation variable speed control for mode-stirred operation.

## **FEATURES**

---

### **FIBER OPTIC INPUT/OUTPUT LINES**

- Eliminate unwanted RF signals generated over wire cables.
- Each primary device cable contains two fiber optic lines (transmit/receive).
- Each auxiliary device cable contains one fiber optic line (transmit only).
- Fiber optic connectors (device and auxiliary) on the back panel are metal ST connectors that are reliable and easy to use.

### **MULTI-DEVICE CONTROL**

- Duplicate front panel controls permit simultaneous and synchronized control of two primary devices and four auxiliary devices in both manual and remote modes.

## **COMPATIBILITY**

- Compatible with the a variety of commercial software including the following:
  - Hewlett Packard Commercial Radiated EMI Measurement Software (HP Part # 85876A).
  - Rohde & Schwarz ES-K1 Emissions Software
  - Quantum Change Tile software
- Backward compatible with previous ETS-Lindgren Models 1050, 1060 and 1090 Controller GPIB command sets (See Appendix A for settings).
- Compatible with the ETS-Lindgren Model 2190 Virtual Controller GPIB command set and VCS interface.

## **SEEK/SCAN FUNCTIONS**

- **SEEK:** Allows for movement of device under control to a target position (valid through GPIB only).
- **SCAN:** Allows for movement of device under control cyclically between pre-programmed limits.

## **TARGET OVERRUN CORRECTION FEATURE**

- Constantly monitors inertia induced target overrun. A special algorithm continually adjusts subsequent positioning to minimize overrun, allowing for proper device positioning during tests.

## **SPECIAL LIMIT SETTING FEATURE**

- When used to control a tower, upper and lower limits can be set independently for both horizontal and vertical polarizations.
- Prevents element damage at upper or lower limit due to a change in polarization.

### **GPIB INTERFACE**

- Complies with IEEE 488 industry standards (488.1 and 488.2 compatible).
- All front panel functions can be exercised using GPIB commands while in the remote mode.
- Provides additional capabilities not available from the front panel, including a variety of SEEK commands.

### **UNIVERSAL POWER SUPPLY**

- Auto ranging - automatically senses supply voltage (no user selection necessary).
- Accepts any AC power source input within the range of 115/230 VAC, 50/60 Hz.

### **RACK MOUNTING**

- Standard rack width.
- 3 U rack size.

## STANDARD CONFIGURATION

### ELECTRICAL

Voltage	90-250 VAC
Frequency	44-440 Hz
Fuse	2 A, 250 VAC Time Delay
Power Inlet	IEC 320
Interface	GPIB (IEE 488)
I/O Ports	Fiber Optic, 2 lines each, 2 primary devices Fiber Optic, 1 line each, 4 auxiliary devices
Batteries	3 Size "AAA" 1.5 V DC Alkaline (type EN92 or equivalent), user replaceable (for parameter backup)

### PHYSICAL

Width	43.8 cm 17.25 in
Depth	38.0 cm (with handles) 13.5 in
Height	13.3 cm 5.25 in
Weight	4.5 kg 10.0 lbs

	<b>Position Resolution</b>	<b>Positioning Accuracy with Overshoot Compensation</b>
Towers:	1mm	$\pm 1$ cm
Turntables:	0.1 degree	$\pm 1$ degree
Reverb:	0.1 degree	$\pm 1$ degree
MAPS:	0.1 degree	$\pm 1$ degree



## OPTIONAL FEATURES

---

Option 1

I/O Ports:  
RF Switch, SPDT, four auxiliary devices

This page intentionally left blank.

# PREPARATION FOR USE

---

---

## UNPACKING THE CONTROLLER

---

The ETS-Lindgren Model 2090 Multi-Device Controller is shipped with an instruction manual, power cord, and appropriate packing material to prevent damage. Carefully remove the Model 2090 and its accessories from the shipping container. Save the packing material for storage and shipping. Check to make sure all contents are intact and report any missing items to the factory. After verifying the contents, proceed with the setup process. Before connecting, configuring, or using the Model 2090, the user should become familiar with the available controls and connections. The following sections describe the front and back panels of the unit.

## FRONT PANEL DESCRIPTION

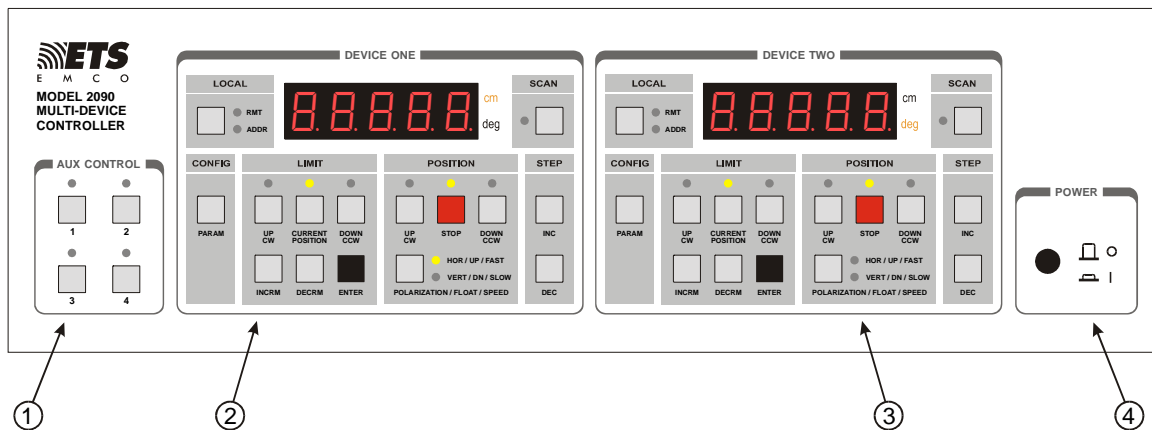

**Figure 1 Model 2090 Front Panel**

1. **AUXILIARY CONTROL BLOCK** – Provides input keys and indicators for the four auxiliary control ports. Pressing a key will toggle the corresponding auxiliary output and indicator on or off.
2. **DEVICE ONE CONTROL BLOCK** – Provides the user interface for Primary Device 1.
3. **DEVICE TWO CONTROL BLOCK** – Provides the user interface for Primary Device 2.
4. **POWER CONTROL BLOCK** – Provides the power toggle switch and power indicator. Power is enabled with the switch depressed. The power indicator should light a few moments after depressing the power switch.

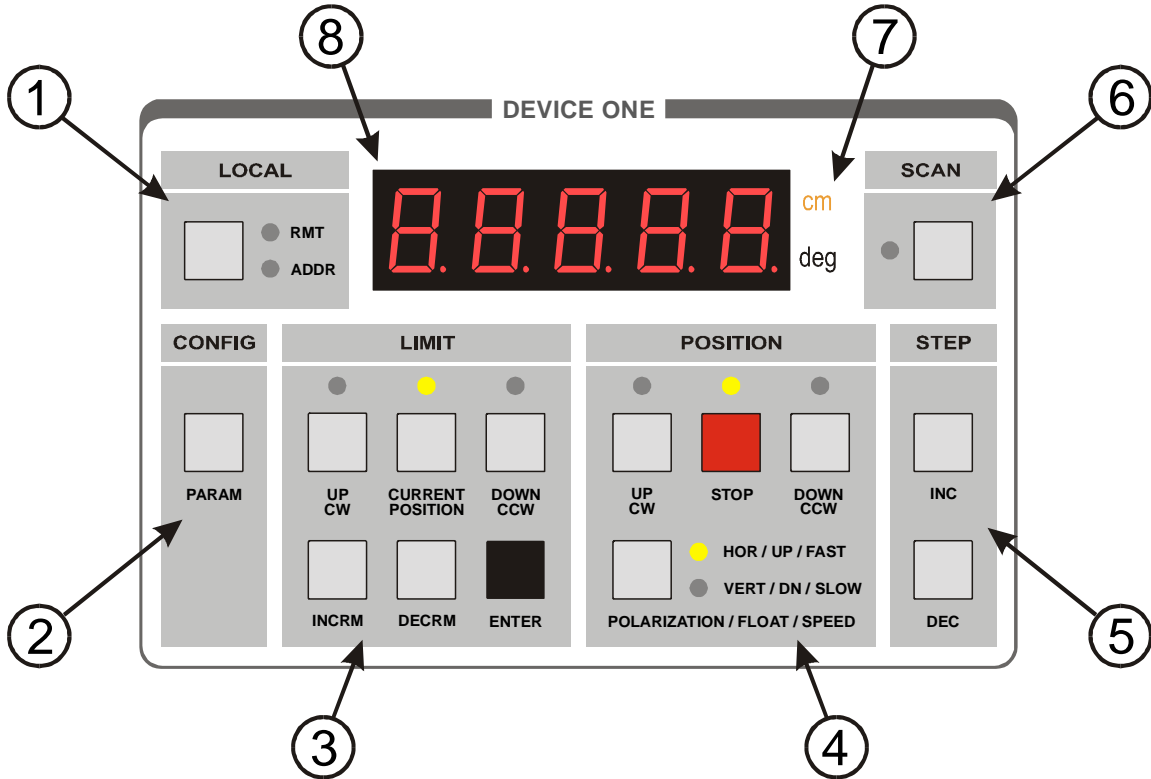

Figure 2 Model 2090 Device Control Block

### 1. LOCAL KEY AND INDICATORS

**LOCAL key** – The **LOCAL** key is a multi-function key which has a different behavior depending on the status of the Model 2090.

- a. Pressing the **LOCAL** key while the corresponding primary device is in remote control mode (**RMT** indicator lit) will return the controller to local control mode.
- b. For a variable speed device, pressing the **LOCAL** key while in local mode and viewing the position displays will activate the speed selection mode, causing the current speed selection to be displayed momentarily in the primary display. The **INCRM** and **DECRM** keys can then be used to adjust the speed selection.

- c. In edit mode (see below), pressing the **LOCAL** key will shift the display digit being edited to the next higher digit.

**RMT (REMOTE) indicator** – This indicator will be lit as long as the corresponding primary device is under remote GPIB control. The front panel keys (except the **LOCAL** key) of this primary device will be disabled while in remote mode.

*NOTE: While user input and control is disabled, the remaining keys may still be used to acknowledge an error condition while in remote control mode.*

**ADDR (ADDRESSED) indicator** – This indicator will strobe to indicate GPIB bus activity while in remote control mode.

## 2. **CONFIGURATION**

**PARAM (PARAMETER) key** – Pressing this key will stop all device motion and display the current entry of the configuration parameter list for this primary device in the corresponding display window. Repeatedly pressing this key will advance to the next parameter in the list.

## 3. **LIMIT KEYS AND INDICATORS**

**UP/CW key** – Pressing this key will display the upper limit for the current polarization of a tower, or the clockwise limit of a turntable, reverberation paddle, or MAPS in the corresponding numerical display.

**UP/CW indicator** – Lights to indicate that the numerical display represents the upper limit of a tower, or the clockwise limit of a turntable, reverberation paddle, or MAPS.

**CURRENT POSITION key** – Pressing this key will display the current position of the primary device in the corresponding display.

**CURRENT POSITION indicator** – Lights to indicate that the numerical display represents the current position of the primary device. This is the default state.

**DOWN/CCW key** – Pressing this key will display the upper limit for the current polarization of a tower, or the counterclockwise limit of a turntable, reverberation paddle, or MAPS in the corresponding display.

**DOWN/CCW indicator** – Lights to indicate that the numerical display represents the lower limit of a tower, or the counterclockwise limit of a turntable, reverberation paddle, or MAPS.

**ENTER key** – Pressing this key toggles the edit mode on or off. With the edit mode off, pressing **ENTER** will initiate edit mode for the currently displayed limit or parameter. Pressing **ENTER** while in edit mode will store the modified limit or parameter and exit edit mode.

*NOTE: This key only works when the device is not in motion.*

**INCRM (INCREMENT) key** – Pressing this key will increment the currently highlighted digit of the limit, position, parameter, or speed selection in the display window. For limits, position, and parameters, if the Model 2090 is not already in edit mode, it will automatically switch to edit mode.

*NOTE: With the exception of changing the speed selection, this key only works when the device is not in motion.*

**DECRM (DECREMENT) key** – Pressing this key will decrement the currently highlighted digit of the limit,

position, parameter, or speed selection in the display window. For limits, position, and parameters, if the Model 2090 is not already in edit mode, it will automatically switch to edit mode.

*NOTE: With the exception of changing the speed selection, this key only works when the device is not in motion.*

#### 4. POSITION KEYS AND INDICATORS

**UP/CW key** – Pressing this key will command the associated primary device to move in the UP or CLOCKWISE direction. Actual motion will depend on the current state of the device and the controller.

**UP/CW indicator** – Lights solid to indicate that the device is moving in the UP or CLOCKWISE direction. Flashes to acknowledge user key-press of the **UP/CW** key and to indicate that the target motion is in the UP or CLOCKWISE direction during reverse delay operations.

**STOP key** – Pressing this key will command the associated primary device to stop motion. Variable speed devices will decelerate to their minimum speed before disabling the drive.

**STOP indicator** – Lights solid to indicate that the device is stopped. Flashes to acknowledge user key-press of the **STOP** key and during deceleration of variable speed devices.

**DOWN/CCW key** – Pressing this key will command the associated primary device to move in the DOWN or COUNTERCLOCKWISE direction. Actual motion will depend on the current state of the device and the controller.

**DOWN/CCW indicator** – Lights solid to indicate that the device is moving in the DOWN or COUNTER-



CLOCKWISE direction. Flashes to acknowledge user key-press of the **DOWN/CCW** key and to indicate that the target motion is in the DOWN or COUNTER-CLOCKWISE direction during reverse delay operations.

**POLARIZATION/FLOAT/SPEED key** – This key has a variety of behaviors depending on the attached primary device type:

- a. For towers, pressing this key toggles the tower boom between horizontal and vertical polarization when the display shows the current position; and toggles the display between horizontal and vertical limit displays when showing an upper or lower limit.
- b. For air-flotation turntables, pressing this key floats or lowers the turntable on its air cushions. The turntable cannot be dropped while in motion.
- c. For two speed turntables, pressing this key toggles the turntable between fast and slow speed.
- d. For standard variable speed turntables, pressing this key advances the selected speed setting to the next preset speed selection.

**HOR/UP/FAST indicator** – This indicator has a variety of behaviors depending on the attached primary device type:

- a. For towers, this indicator lights solid to indicate that the tower is polarized horizontally. This indicates the status of the polarization solenoid only, and may or may not reflect the actual position of the tower's cross boom at any given instant. This indicator flashes to indicate that the display is showing the upper or lower limit for the horizontal polarization, while the tower is still polarized vertically.

- b. For air-flotation turntables, this indicator lights solid to show that the air flotation solenoid has been activated.
- c. For two speed turntables, this indicator lights solid to show that the turntable motor is set to high speed.
- d. For standard variable speed turntables, this indicator lights in a binary fashion with the **VERT/DN/SLOW** indicator to represent the least significant bits of the current speed selection. See the section on “OPERATION” for more information on this display.

**VERT/DN/SLOW indicator** – This indicator has a variety of behaviors depending on the attached primary device type:

- e. For towers, this indicator lights solid to indicate that the tower is polarized vertically. This indicates the status of the polarization solenoid only, and may or may not reflect the actual position of the tower’s cross boom at any given instant. This indicator flashes to indicate that the display is showing the upper or lower limit for the vertical polarization, while the tower is still polarized horizontally.
- f. For air-flotation turntables, this indicator lights solid to show that the air flotation solenoid has been de-activated.
- g. For two speed turntables, this indicator lights solid to show that the turntable motor is set to low speed.
- h. For standard variable speed turntables, this indicator lights in a binary fashion with the **HOR/UP/FAST** indicator to represent the least significant bits of the current speed selection. See the section on “OPERATION” for more information on this display.

## 5. STEP KEYS

**INC (INCREASE) key** – This key has two functions:

- a. Pressing this key while viewing position information will command the associated primary device to move in the UP or CLOCKWISE direction until the key is released. Actual motion will depend on the current state of the device and the controller.
- b. Pressing this key while viewing the parameter list will move up the parameter list by one entry, allowing the user to scroll back through the parameter list.

**DEC (DECREASE) key** – This key has two functions:

- a. Pressing this key while viewing position information will command the associated primary device to move in the DOWN or COUNTERCLOCKWISE direction until the key is released. Actual motion will depend on the current state of the device and the controller.
- b. Pressing this key while viewing the parameter list will move down the parameter list by one entry, allowing the user to scroll forward through the parameter list (same as pressing the **PARAM** key).

## 6. SCAN KEY AND INDICATOR

**SCAN key** – This key toggles the scan mode on or off. When activated, the associated primary device will move between the upper/clockwise and lower/counterclockwise limits for the number of cycles specified by the scan cycle parameter,  $P3$ . See the “MODEL 2090 PARAMETER LIST” for more information.

**SCAN indicator** – This indicator is lit as long as the scan mode is activated.

## 7. UNIT INDICATORS

**cm indicator** – This indicator is lit for devices configured as towers, to indicate that the position and limit information is displayed in centimeters.

**deg indicator** – This indicator is lit for devices configured as turntables, to indicate that the position and limit information is displayed in degrees.

## 8. PRIMARY DISPLAY

This five digit, seven-segment display provides the primary feedback for the user interface. It is used to display current position information, limit settings, parameter settings, speed selection, error messages, and other alphanumeric messages.

## STANDARD BACK PANEL DESCRIPTION

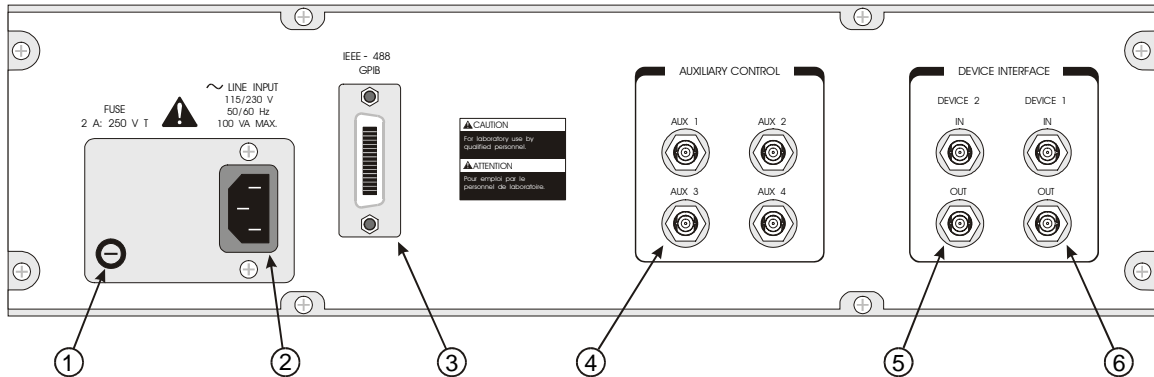

**Figure 3 Model 2090 Standard Back Panel**



- 1. AC POWER FUSE** – This is the AC power fuse holder. Replace the fuse with the power off and the power cord disconnected from the unit, and only with a fuse of the same rating. Failure to do so may cause personal injury or instrument damage and will void the warranty.



- 2. IEC POWER INLET** – This is the IEC 320 power inlet. Attach an appropriate power cord between this inlet and the power mains. This is a grounded outlet and provides the safety earth ground for the instrument. Never attempt to defeat the safety features of the device. Doing so may cause personal injury or instrument damage and will void the warranty.

- 3. GPIB PORT** – This is the IEEE 488 GPIB interface port. It is used to connect the Model 2090 to a PC or other GPIB bus controlling device using a standard GPIB cable.

- 4. AUXILIARY CONTROL** – These are the ST-type fiber optic output connectors for the four auxiliary device

controls. They provide simple on/off control for remote devices fitted with an auxiliary device input.

5. **DEVICE 2 INTERFACE** – These are the ST-type fiber optic I/O connectors for primary device number two. One channel of a duplex fiber optic cable connects from the OUT connector of the controller to the IN connector of the primary interface of a device (tower, turntable, etc.). The second channel connects from the OUT connector of the primary interface of the device to the IN connector of the controller.

*NOTE: Older motor base designs do not have a secondary fiber optic interface. The secondary interface on newer devices is currently reserved for future expansion.*

6. **DEVICE 1 INTERFACE** – These are the ST-type fiber optic I/O connectors for primary device number one. One channel of a duplex fiber optic cable connects from the OUT connector of the controller to the IN connector of the primary interface of a device (tower, turntable, etc.). The second channel connects from the OUT connector of the primary interface of the device to the IN connector of the controller.

*NOTE: Older motor base designs do not have a secondary fiber optic interface. The secondary interface on newer devices is currently reserved for future expansion.*

## OPTIONAL BACK PANEL DESCRIPTION

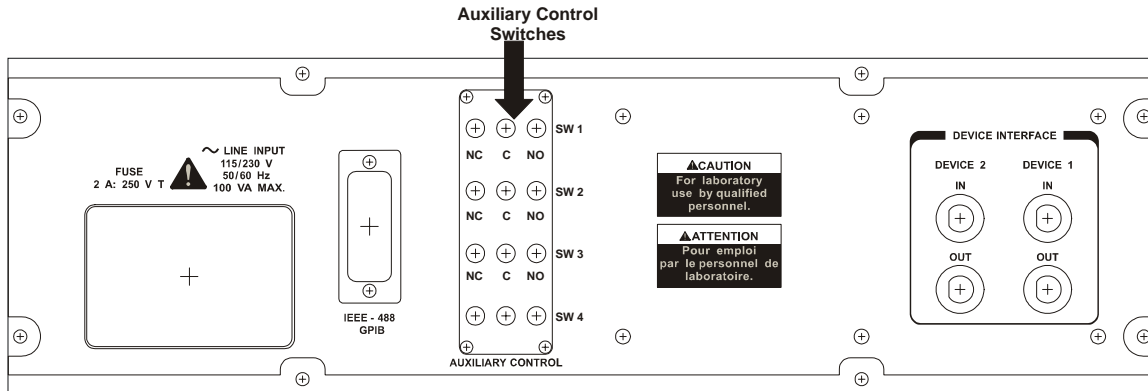

**Figure 4 Model 2090 Option 1 Back Panel**

**AUXILIARY CONTROL** – Auxiliary devices use a single-pole double-throw RF relay to control simple on/off operation. The connection type is SMA.

## POWER REQUIREMENTS

---

The Model 2090 accepts any AC power source input within the range of 115-230 VAC, 50/60 Hz. It is not necessary to select a voltage. To apply AC power, use the three-conductor power cable that is shipped with the controller. When connected from the IEC 320 power inlet to an appropriate AC power source, the instrument chassis will be connected to the earth ground.



---

**CAUTION:** *Before switching on, connect the protective earth terminal of this instrument to the protective conductor of the power cord. The power cord should only be connected to a socket outlet provided with a protective earth contact. Do not use an extension cord without a protective earth connector. Never attempt to defeat any safety feature of an electrical device or serious injury may result.*

---

The Model 2090's configuration and current settings are backed-up by non-volatile RAM (NVM). The NVM retains these settings in the event of power loss or power down. Three (3) AAA alkaline batteries, located internally, are needed for this memory back up. Refer to the procedure in the section “NVRAM Battery Backup” in Appendix B: Maintenance, for more information on replacing these batteries.

*NOTE: It is recommended that the batteries be replaced annually to reduce the risk of potential memory loss.*



## RACK MOUNTING

The Model 2090 controller can be ordered with a rack mount option (Part # 540037). This option can be either factory or field installed. The rack mount option provides capability for installing the controller in a universal E. I. A. 48.26 cm (19.0 in) rack. A rack height of 13.34 cm (5.25 in) is required.

## DEVICE CONNECTIONS

Any combination of primary devices (towers, turntables, reverberation paddles, MAPS, etc.) can be connected to the two Device Interface ports located on the rear panel of the controller. For easy set up of an EMC facility, it is recommended that the tower be connected to the Device 1 interface port and the turntable be connected to the Device 2 interface port, since these are the controller's default settings. Reverberation paddles and each axis of the Multi-Axis Positioner behave similar to turntables, and should be configured as such. Primary device connection is accomplished by way of a dual fiber cable included with the device. This cable terminates into two ST connectors that are identical at both ends. The cable is symmetrical; either end can be connected to the controller. A fiber optic cable that is connected to the IN port of a device should, at the other end, be connected to the primary OUT port of the motor base. A fiber connected to the OUT port of the device should, at the other end, be connected to the primary IN port of the motor base. Older motor base designs have only one fiber optic connector pair, while the newest motor

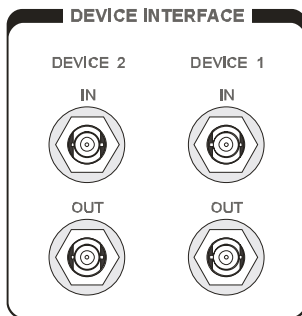

base interface provides a secondary interface reserved for future expansion.

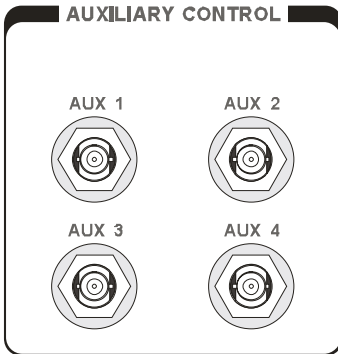

Additional devices (for example: Remote Air Polarized Tripods, LISNs, EUTs, etc.) can be connected in any sequence to the four Auxiliary Control Ports (located on the rear panel). If there are less than four auxiliary devices connected to the controller, it is recommended (not required) that these devices be connected in numerical order, starting with the Auxiliary Control Port 1. The Auxiliary Ports are also standard ST fiber optic connectors. Auxiliary Port Enabled products, such as air polarized tripods, are provided with a single fiber cable with ST connectors at both ends. Either end may be attached to the 2090.

*NOTE: Fiber optic cabling for each device should not be allowed to hang unsupported from the rear panel of this controller. The fibers and connectors are easily broken if twisted or bent too much. Keep the fiber optic cables as straight as possible from the connector to the protective sheath.*

## OPTIONAL DEVICE CONNECTIONS

---

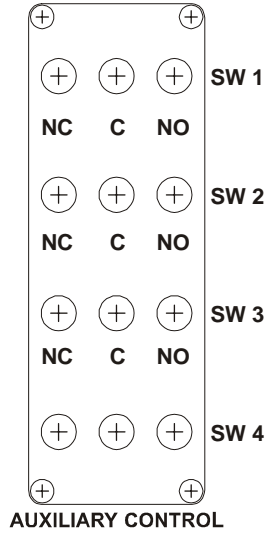

Auxiliary devices use a single-pole, double-throw RF relay to control simple on/off operation. The connection type is SMA. Additional devices (for example: CMU, Analyzers, dual polarized horn antennas, etc.).

## GPIB INTERCONNECTIONS

---

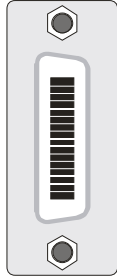

The Model 2090 is compatible with the General Purpose Interface Bus as described in the IEEE 488.1/488.2 standard. A "D" connector has been provided on the 2090 rear panel for connection to a GPIB bus.

*NOTE: When making this connection, do not stack more than three cables on any one connector. This eliminates undue mechanical stress on the connector and rear panel. Also, be sure to screw the two-connector lock-screws finger tight to avoid a loose connection during operation.*

*NOTE: The controller's talker/listener bus address can be set through the front panel. Instructions on how to perform this operation may be found in "Initialization" under the subsection "Configuring For Use".*

# INITIALIZATION

---

---

## STARTUP

---

The devices that will be controlled by the Model 2090 must be properly connected to the controller before applying power to the unit. If nothing is connected to the Model 2090 when power is applied the Device One and Device Two displays will show dashes (-----).

The Model 2090 controller has a power-up diagnostic/self-test to check for internal problems found during initialization. During this period, the all display indicators will flash on for several seconds to allow a visual inspection, and then the firmware revision number will be displayed in the left-hand (Device One) display window as r X.XX where X.XX is the version number. If an internal error is found during the startup sequence, an error message "EXXX" will appear in the Device One display, where XXX is the error code.

**RECOVERABLE ERRORS:**

The following errors indicate a recoverable problem that may require user intervention. These errors can be cleared by pressing any key on the front panel to acknowledge the error. These errors can also be cleared remotely through the GPIB Status reporting structure described in the section “USING THE GPIB COMMAND SET WITH THE MODEL 2090” subsection “GPIB Status Reporting”.

*E001* NVM Initialization Error. Parameter settings were lost and restored to factory defaults. This error usually indicates that the NVM backup batteries are dead and should be replaced. See the procedure in the section “NVRAM Battery Backup” in Appendix B: Maintenance, for more information.

**SYSTEM TEST FAILURES:**

The following errors are of a more serious nature and may indicate that service is needed. In the event of such an error, power off the unit for several seconds and power it back on. If the error recurs, contact ETS for service.

*E100* ROM test error: ROM has been detected as being corrupt.  
*E101* RAM test error: RAM has been detected as being corrupt.  
*E102* NVM test error: NVM has been detected as being corrupt.  
*E103* Low Power Test error: Power test failed.  
*E104* GPIB Test error: GPIB test failed.

### **HARDWARE ERRORS:**

The following errors are not limited to the startup process, and should not occur under normal operation. In the event of such an error, power off the unit for several seconds and power it back on. If the error recurs, contact ETS for service.

<i>E996</i>	BERR Error
<i>E997</i>	Uninitialized Interrupt
<i>E998</i>	Spurious Interrupt
<i>E999</i>	Invalid Interrupt Error

Refer to “Appendix B” for more information on error conditions and possible causes.

---

## EDITING PARAMETERS

---

The Model 2090 provides a versatile user interface for editing configuration parameters, limits, and the current position, by allowing several keys to perform multiple duties. Prior to editing any settings, all device motion should be stopped. The Model 2090 will automatically stop device motion when configuration parameters are displayed, and prevent the editing of limit and position values while in motion, but the user should avoid attempting to modify these values while equipment is in motion to avoid unexpected results.

To edit the limits or current position settings, select the appropriate limit or position by pressing the corresponding button under the **LIMIT** key group. The associated indicator should light and the display will show the corresponding value. For a tower, the 2090 provides two sets of limits, one for horizontal polarization and one for vertical, in order to protect antenna elements from damage due to accidental polarization at the top or bottom of the mast. Pressing the **POLARIZATION** key while the upper or lower limit is displayed will switch the display to show the corresponding limit for the opposite polarization, **without changing the tower polarization**. To indicate that the displayed value and polarization is not the current polarization, the indicator light by the **POLARIZATION** key will flash on and off. While in this state, the limit can be changed using the limit edit keys just the same as any other parameter.



*NOTE: In order to toggle the polarization of the tower from the front panel, the display must be showing the current position, and not either limit.*

To edit a configuration parameter, press the **PARAM** key to display the current parameter. Pressing the **PARAM** key repeatedly will scroll down through the parameter list, showing each parameter in turn. While viewing a parameter, the **STEP** keys (**INC/DEC**) may be used to scroll up or down the parameter list. This reduces the effort necessary to scan through a long parameter list using the **PARAM** key. Pressing any of the **LIMIT/POSITION** selection keys will return the display to that selection. Pressing any of the remaining motion keys will return the display to the current position and execute that motion. Pressing the **PARAM** key again will return to the last displayed parameter in the list, allowing easy transition between parameter adjustment and device operation.

Once the desired limit, position or parameter is visible in the display window, pressing **INCRM**, **DECRM**, or **ENTER** will toggle into edit mode. The lowest adjustable digit will flash on and off. Pressing the **LOCAL** key for that device will switch the flashing digit to the next higher digit. In this way, it is possible to rapidly adjust any digit of a multi-digit parameter or limit.

*NOTE: Some parameters only have one digit, or a fixed range of selections. For those parameters, such as bore sight separation distance, the whole entry to be changed will flash. Other parameters consist of single on/off toggles*

*or activate specific controller functions. The edit behavior of these parameters is described in the parameter table.*

Using the **LOCAL** key to select the appropriate digit and the **INCRM** and **DECRM** key to adjust the setting, any value can be entered quickly. Once the desired value is shown in the display, pressing **ENTER** will store the new value. Pressing any key other than **LOCAL**, **INCRM**, **DECRM**, or **ENTER** will exit the edit mode without saving the value and perform the action associated with that key.

When editing limits or the current position setting, the 2090 will not allow the current position to be set outside the software limits, nor can the upper or lower limits be adjusted below or above, respectively, the current position or each other.

## CONFIGURING FOR USE



Before using the Model 2090, it must be configured to match the primary devices connected to it. To the Model 2090, all primary devices are generic motor bases, with the ability to move in two directions, report an encoder position, and perform a few other basic functions. To activate behavior specific to a certain type of device, i.e. a bore sight tower or a two-speed turntable, it is necessary to enter additional information into the Model 2090's configuration parameters table. The previous section describes the process for entering these parameters. This section describes each parameter and their typical settings. The default factory preset configuration is given below.

### 2090 Default Configuration:

Parameter	Value	Description
P1	1	Tower
P2	0	Standard (non-bore sight) tower
P3	000	Infinite scan count
P4	00	0 cm polarization offset
P5	0	Standard bore sight correction
P8	05	0.5 second reverse delay
P9	8	Primary GPIB address 8
B1	000	User options disabled
c	2000	2000 encoder counts per meter
S0	-1	Step speed = run speed
S1	31	Speed 1 ~12.5% of max speed
S2	63	Speed 2 ~25% of max speed
S3	95	Speed 3 ~37.5% of max speed
S4	127	Speed 4 ~50% of max speed
S5	159	Speed 5 ~62.5% of max speed
S6	191	Speed 6 ~75% of max speed
S7	223	Speed 7 ~87.5% of max speed
S8	255	Speed 8 = max speed
Oc	On	Overshoot compensation enabled
ACC	20	Acceleration = 2 seconds

*Snd* 1 Remote sounds enabled

Lower Limit: 050.0 cm  
 Upper Limit: 400.0 cm  
 Current Position: 100.0 cm

Parameter	Value	Description
<i>P1</i>	0	Turntable
<i>P2</i>	0	Standard turntable
<i>P3</i>	000	Infinite scan count
<i>P5</i>	1	Non-continuous rotation
<i>P8</i>	25	2.5 second reverse delay
<i>P9</i>	9	Primary GPIB address 9
<i>b1</i>	000	User options disabled
<i>c</i>	3600	3600 encoder counts per meter
<i>S0</i>	-1	Step speed = run speed
<i>S1</i>	31	Speed 1 ~12.5% of max speed
<i>S2</i>	63	Speed 2 ~25% of max speed
<i>S3</i>	95	Speed 3 ~37.5% of max speed
<i>S4</i>	127	Speed 4 ~50% of max speed
<i>S5</i>	159	Speed 5 ~62.5% of max speed
<i>S6</i>	191	Speed 6 ~75% of max speed
<i>S7</i>	223	Speed 7 ~87.5% of max speed
<i>S8</i>	255	Speed 8 = max speed
<i>Oc</i>	<i>On</i>	Overshoot compensation enabled
<i>ACC</i>	20	Acceleration = 2 seconds
<i>Snd</i>	1	Remote sounds enabled

CCW Limit: 000.0 degrees  
 CW Limit: 360.0 degrees  
 Current Position: 180.0 degrees

# MODEL 2090 PARAMETER LIST

---

The following table describes each parameter and the available settings. In general, the term “tower” will be used to refer to any linear positioning device, and the term “turntable” will refer to any rotational positioner.

Parameter	Description
P1	Refers to the principal type of device to be controlled: 0 = Turntable, Reverberation Paddle, MAPS, or other rotational positioner. 1 = Tower or other linear positioner.
P2	Refers to model specific features of device to be controlled: 0 = Standard Turntable / Tower 1 = Air Flotation Turntable / Bore Sight Tower 2 = Two Speed Turntable  <i>NOTE: Parameter P2 for a turntable no longer supports a setting 3 = Variable Speed Turntable/Tuner, which was introduced in V 2.25. Instead, the 2090 now checks what type of motor base is attached and automatically enables variable speed if it is available.</i>
P3	Refers to SCAN cycle count in full cycles: 1-999 = Number of complete circuits to perform from one limit to the other and back again. 000 = Infinite scan count; scan mode does not automatically terminate.  The Model 2090 also supports a half-cycle scan count through the GPIB interface.

---

**P4** Refers to two different tower corrections, depending on the tower type:

For a standard tower, this value represents the polarization offset, in the range of  $\pm 50$  cm, applied to the tower position reading when the polarization is changed. This parameter allows for correction of the antenna height changed caused when centerline rotation is not available or not in use.

For a bore sight tower, this parameter is used to enter the bore sight separation distance corresponding to the configuration of the tower. This value can be 3, 10, or 30 meters, and configures the 2090 to correct for the difference in height between the carrier position and the actual antenna position.

---

**P5** For bore sight towers, refers to the bore sight mast height correction:  
0 = Standard bore sight towers  
1 = Custom or alternate bore sight tower

Currently, all six-meter tall 2070 series bore sight towers use the default correction table. The alternate selection provides a correction table for a shorter five-meter tower with a different cam mechanism. In future revisions, the 2090 may provide support for other bore sight tower designs either by adding additional tables or by allowing the user to download the appropriate correction table for the attached tower.

For turntables, refers to turntable rotation mode:  
0 = Continuous  
1 = Non-continuous

In the continuous mode of operation a turntable is allowed unlimited movement. The counter readout is from 0 to 359.9 and the software limits are ignored in this mode of operation. This is the desired setting for reverberation paddles.

*NOTE: For turntables equipped with hardware limits, they must be disengaged for this mode to work correctly.*

In the non-continuous mode, the turntable motion is restricted between the upper and lower software limits. These limits are adjustable between  $-999.9$  to  $999.9$ .

---

**P8** Refers to the motor reverse delay, in seconds. This parameter allows setting the reverse delay used between direction changes. This is the period of time for which the motor must remain off before allowing it to move in the other direction. For split-phase motors, it is critical that the motor come to a complete stop prior to reversing direction, or the motor will continue moving in the same direction and cause a Moving Wrong Direction error (E004). For other motors, physical damage may be caused to the motor or device from reversing the motor too quickly. This parameter should be used with care. If in doubt use the factory default setting.

---

**P9** Refers to the primary GPIB address for each device. Valid values are in the range from 1 to 30 (0 is normally reserved for the controller in charge; i.e. the computer). Each device must have a unique GPIB address.

---

**b 1** Refers to bit-wise parameter number one. This parameter provides selective enabling of several customizable parameters. The bits are displayed in increasing order from right to left. Unless otherwise indicated, a value of 0 indicates that the option is disabled and a value of 1 indicates it is enabled. The two bits currently defined for **b 1** are:

Bit 0 – Limits STEP controls (INC/DEC) to only allow motion within the soft limits instead of the hardware limits of the motor base.

Bit 1 – Provides a quick stop option for the STEP controls (INC/DEC) on variable speed devices. Enabling this bit (setting it to 1) will bypass the deceleration ramp on variable speed motor bases, stopping them as quickly as possible. *NOTE: This option should be used with caution, since it is possible to cause damage to the device or equipment attached to the device.*

---

**[** Refers to the encoder calibration parameter. This setting is used to convert the encoder count values returned from a motor base into the corresponding centimeter or degree position reading. For towers, the number represents the number of encoder counts per meter. For turntables, it represents the number of counts per revolution. Using this parameter, a variety of standard, retrofit, and custom devices can be used. The settings for various products are listed below:

Model 2075 Mini-Mast:	1620
All other EMCO 2070 series towers:	2000
Model 2065 LoPro Turntable:	3665

---

---

Model 2081 Turntables:	3608
Model 2088 EuroPro Turntable:	4500*
Model 5901 Mode Tuner:	6000**
Multi-Axis Positioning System:	4500
All other model 2060/2080 series turntables:	3600
All other current ETS-Lindgren rotational devices:	3600

*\*Early revisions of the Model 2088 used 4750 for the Euroshield versions and 4800 for the U.S. version.*

*\*\*Early revisions of the Model 5901 Mode Tuner used 6400.*

If the device is not listed, or the given value does not appear to work correctly, the encoder calibration value can be determined using the following procedure:

#### **FOR TOWERS,**

1. Set the encoder calibration value to 1000.
2. Insure that the tower is positioned to allow at least a meter of travel in the upward direction at an easily measurable height, and then set the current position reading to 000.0.  
*NOTE: It will be necessary to adjust the lower limit setting to allow this.*
3. Using the **STEP** keys, adjust the height of the carrier until it is one meter above the start point.
4. Record the reading of the display, ignoring the decimal point (i.e. 200.0 would be 2000). This is the encoder calibration value. *NOTE: If the value is below 1000, the resolution of the encoder is low and thus the 2090 will not provide 0.1 cm resolution, even though the display shows that digit. If the value has gone past 9999, the encoder has too many counts per meter and the 2090 can not correct for it. In this case, contact ETS for assistance.*
5. Enter this value for the encoder calibration value and reset the limits and position information.
6. Test the tower by moving it a known distance and comparing the display to the measured distance traveled. It may be necessary to adjust the encoder calibration value up or down slightly depending on the result.

#### **FOR TURNABLES,**

1. Set the encoder calibration value to 3600.
  2. Insure that the turntable is positioned to allow more than a full revolution of travel in the clockwise direction and use the **STEP** keys to run the turntable clockwise a few degrees to remove any play in the table.
  3. Mark the current location of the turntable against the ground
-



ring (masking tape works well), and set the current position reading to 000.0.

4. Using the **STEP** keys, rotate the turntable clockwise until it is again aligned with the mark on the ground ring. For best results, the last motion should always be in the clockwise direction to insure that any play in the gearing between the motor and encoder is accounted for.
5. Record the reading of the display, ignoring the decimal point (i.e. 360.0 would be 3600). This is the encoder calibration value. *NOTE: If the value is below 3600, the resolution of the encoder is low and thus the 2090 will not provide 0.1 degree resolution, even though the display shows that digit. If the value has gone past 9999, the encoder has too many counts per meter and the 2090 can not correct for it. In this case, contact ETS for assistance.*
6. Enter this value for the encoder calibration value and reset the limits and position information.
7. Test the turntable by moving it a complete revolution and comparing the alignment marks. It may be necessary to adjust the encoder calibration value up or down slightly depending on the result. *NOTE: When scanning between limits, it is not uncommon to have a small discrepancy between the absolute position of the table and the display on the 2090. This is because reversing the direction of rotation reverses any gear play between the encoder and the table top, allowing that play to be visible in the positioning accuracy.*

---

**50** Refers to the speed setting for variable speed devices when the **STEP** (INC/DEC) keys are used.

- 1 Disabled. The **STEP** keys will cause the device to move at the same speed as the other motion keys.
- 0-255 Defines the speed setting for motion caused from the **STEP** keys. This allows the **STEP** keys to be used for fine adjustment at a constant speed, while having all other motion governed by the selected speed setting.

This parameter is only visible for variable speed devices. See the next entry for more information on speed settings.

---

---

**S1-S8** Refers to the eight possible preset speed settings for variable speed devices. Each of these parameters can be set to any value from 0 to 255, with the resulting device speed being given approximately by the formula:

$$\text{Speed} = N (\text{MaxSpeed} - \text{MinSpeed}) / 255 + \text{MinSpeed}$$

Where N is the speed setting from 0 to 255.

Each speed setting has its own individual overshoot compensation value to provide proper overshoot correction for each speed selection. However, the new ramp control provided by the 2090 and the enhanced MB-IV motor base firmware will normally make overshoot compensation unnecessary. The device will decelerate prior to reaching the target value and creep in at the minimum speed.

*NOTE: It is the nature of variable speed drives that there is a minimum speed at which the motor will operate. All ETS-Lindgren variable speed devices are factory adjusted to insure that the device will be able to operate properly in this range under normal load conditions. However, under heavy load or other unexpected conditions, it may be necessary to increase the minimum speed settings. Below this setting, the motor will not be able to cause rotation, but will be active until a Motor Not Moving error (E002) occurs. **WARNING: Never operate any device in a stalled condition. Doing so can cause damage to the drive unit and will invalidate the warranty!** Always insure that the minimum speed setting specified in the S0-S8 parameters is above the minimum value at which the device will operate under normal load.*



These parameters are only visible for variable speed devices.

---

**PCLR** Invokes the Parameter Clear menu option. Pressing the ENTER key will display *SURE* in the display. Pressing ENTER a second time will clear the parameters for this device to their factory defaults. Pressing any other key will abort the operation and perform the associated action.

---

---

**OSCLR** Invokes the Overshoot Clear menu option. Pressing the ENTER key will display *SURE* in the display. Pressing ENTER a second time will clear the overshoot compensation values for this device. Pressing any other key will abort the operation and perform the associated action.

On occasion, certain motion error conditions, such as hardware limit hit (E005), can cause the overshoot compensation values to become corrupted, resulting in erratic behavior. The most common symptom of this is that each time the device is commanded to move it will move halfway to the target and stop. At this point, the automatic updating of the overshoot compensation values is overridden and can only be corrected by manually clearing the values. Once cleared, the normal overshoot compensation will be restored after several motion cycles of the device.

---

**OC** Refers to the Overshoot Compensation Enable/Disable parameter. Pressing the INCRM and DECRM keys will toggle this between overshoot compensation being on or off. Pressing the ENTER key will save the selected setting.

**On/OFF**

For variable speed devices with creep capability, overshoot compensation is not needed and will interfere with normal table operation in the case of occasional overshoot events. Also, some software designed to work with older ETS-Lindgren controllers provide their own form of overshoot compensation. This can typically be disabled within the software to allow the 2090 to control overshoot compensation, but this parameter can also be used to allow the software to provide the compensation instead.

---

---

**ZERO** Invokes the Zero Reference menu option. Pressing the ENTER key will display *SURE* in the display. Pressing ENTER a second time will initiate a zero search sequence. Pressing any other key will abort the operation and perform the associated action.

Once initiated, the search sequence will move the device in the DOWN/CCW direction until the zero point is detected. The current position setting is then adjusted to represent the absolute position with respect to the zero pulse. *NOTE: Overshoot will normally result in the displayed position being somewhat less than zero. This is normal, and the position is correct.* Pressing any motion control key, or encountering a motion error while the sequence is in progress, will abort the scan and return the device to normal operation.

This parameter is only available on motor bases that provide an absolute zero reference pulse.

---

**BASE** Provides the firmware version of the motor base for information purposes only. Pressing the ENTER key will toggle between the BASE parameter display and the motor base firmware version number. The possible displays are as follows:

**2090** Indicates older (pre-1997) motor base firmware, which only supports standard up/down/polar settings through a simple binary communication protocol. (MB-III)

**HH** Two digit hexadecimal number – Indicates 2190 compatible motor base firmware. This firmware provides more intelligent control from within the motor base, reducing the communications overhead between the motor base and controller. (MB-III)

**XX.XXx** Decimal version number (of the form *107A*, for example) – Indicates the MB-IV motor base interface board, which is capable of flash upgrades and enhanced functionality.

**Emu 1** Indicates the controller is in emulation mode.

---

**ACC** This is the acceleration setting for variable speed devices. The number setting represents the time in seconds for the positoiner to reach full speed. For high inertial loads a longer acceleration time might be required.

---

**EEI P** This displays the motor and control board temperatures denoted by “A” and “B”. Toggle between the two by pushing the INCRM and DECRM buttons.

---

---

*Snd* This is the sound configuration setting for the motorbase speaker. The motorbase can output audible indications for errors, movement, and remote control feedback. 0 = All sounds disabled, 1 = Key press sounds enabled for hand control function, 2 = Error indications enabled, 3 = Motion sounds enabled. With all sounds enabled the motorbase will emit an audible noise if any error condition should arise and a warning indication during movement.

---

Using the technique described previously, adjust the necessary parameters so that they match the configuration of the attached devices. Typical configurations are likely to require adjusting parameters  $P1$ ,  $P2$ , and  $L$  at a minimum. Bore sight towers will also require the setting of parameter  $P4$  to set the separation distance. The remaining parameters are generally set to cover user preferences or custom configurations.

*NOTE: Do not change parameters of a device while another device is in operation. Doing so will cause the other device to stop motion.*

Once the parameters have been configured for each device, check and adjust the limits as necessary. Remember to adjust the limits for both horizontal and vertical polarizations on towers.

This page intentionally left blank.

# OPERATION

---

---

## MANUAL OPERATIONS

---

The front panel of the Model 2090 provides the interface for two separate and complete device controllers, each with identical displays and function keys. By default, both controllers are in manual (LOCAL) mode unless given any command from a device on the GPIB bus (usually a computer with a GPIB card installed). When in the remote mode the RMT indicator light will remain on and the ADDR indicator light will strobe with bus activity. Pressing the **LOCAL** key, for Device 1 or 2, will return only the specific device to local mode. Auxiliary devices are always available from both the front panel of the Model 2090 and the GPIB interface, regardless of the remote or local state of the primary devices.

In manual mode, the motion and behavior of the attached devices can be controlled through the front panel user interface. The front panel controls allow the user to move the primary device in between software limits, either continuously or momentarily in one direction, or to automatically scan from one limit to the other and back again. Where supported by the attached hardware, it also allows the user to change device specific functions like polarization, speed, and flotation state.

## USING LOCAL FUNCTIONS

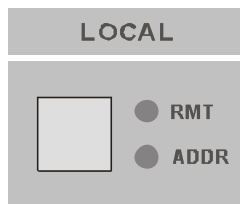

Pressing the **LOCAL** function key will cause the Model 2090 to exit remote mode, unless the unit has been remotely set to the Remote With Lockout State (RWLS) using the appropriate GPIB command codes (refer to the documentation provided with the controlling GPIB device for information on setting RWLS). When the controller exits remote mode, it enters manual mode and remains there until it receives the next GPIB command. Unless given a GPIB command, the controller will automatically be in the manual mode of operation. It is not possible to enter remote mode by pressing the **LOCAL** key.

## USING POSITION FUNCTIONS

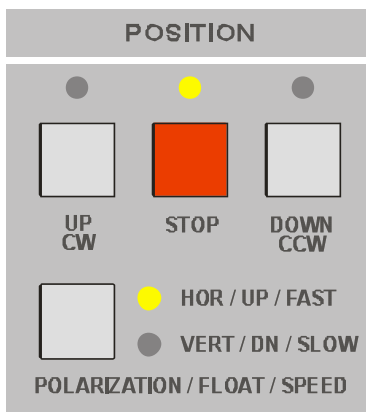

While in manual mode, the **POSITION** keys control the continuous motion of the attached device.

### TO MOVE UP/CLOCKWISE

To initiate continuous motion in the upward or clockwise direction, press the **UP/CW** key under the **POSITION** key group. If the device is not moving and is below the upper/clockwise software limit (viewed by pressing the **UP/CW** key in the **LIMIT** group), the UP/CW indicator will light and the device will start moving in that direction. If the device is already moving in the same direction, it will continue moving to the upper/clockwise soft limit. If the device is moving in the opposite direction, the UP/CW indicator light will flash to indicate that the 2090 has recognized the command. The device will decelerate (if



equipped with variable speed control) and then the **STOP** motion indicator will illuminate for the Reverse Delay period (see Parameter  $P\bar{B}$ ) before moving in the requested direction. At that point, the **UP/CW** indicator will light solid. In all cases, motion will continue until the device reaches the soft limit, the hardware limit (if equipped), or until another motion command is issued.

### **TO MOVE DOWN/COUNTERCLOCKWISE**

To initiate continuous motion in the downward or counterclockwise direction, press the **DOWN/CCW** key under the **POSITION** key group. If the device is not moving and is above the lower/counterclockwise software limit (viewed by pressing the **DOWN/CCW** key in the **LIMIT** group), the **DOWN/CCW** indicator will light and the device will start moving in that direction. If the device is already moving in the same direction, it will continue moving to the lower/counterclockwise soft limit. If the device is moving in the opposite direction, the **DOWN/CCW** indicator light will flash to indicate that the 2090 has recognized the command. The device will decelerate (if equipped with variable speed control) and then the **STOP** motion indicator will illuminate for the Reverse Delay period (see Parameter  $P\bar{B}$ ) before moving in the requested direction. At that point, the **DOWN/CCW** indicator will light solid. In all cases, motion will continue until the device reaches the soft limit, the hardware limit (if equipped), or until another motion command is issued.

## TO STOP MOTION

To stop device motion, press the **STOP** key. The device will decelerate (if equipped with variable speed control), with the **STOP** motion indicator flashing to acknowledge the key press, and then the motor drive will be disabled and the **STOP** indicator will illuminate solid.

## USING LIMIT FUNCTIONS

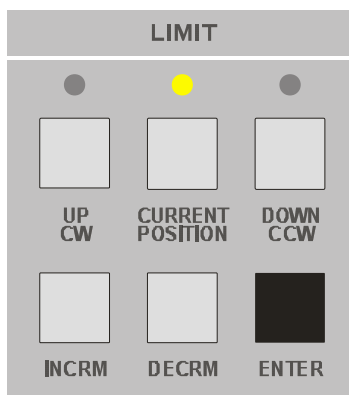

To set the lower/counterclockwise limit for the device under control, press the **DOWN/CCW** key under **LIMIT**. The indicator above this key will light. Set the limit by pressing the **INCRM** and **DECRM** keys under **LIMIT** until the desired limit is shown on the display. Then, press the **ENTER** key. To set the upper/clockwise limit for the same device press the **UP/CW** key under **LIMIT**. The indicator light above this key will light. Set the limit by pressing the **INCRM** and **DECRM** keys under **LIMIT** until the desired limit is show on the display. Press the **ENTER** key. To check the current position of the device under control press the **CURRENT POSITION** key under **LIMIT**. The indicator above this key will light and the device's current position will appear on the display.

*NOTE: Two sets of upper and lower tower limits can be set for horizontal and vertical antenna polarization. When modifying these limits, keep in mind that only the limit of the current polarization is being changed.*

*NOTE: The current position cannot be changed to a value greater than the upper limit or less than the lower limit.*

*The lower limit must always be less than or equal to the upper limit.*

## USING THE SCAN FUNCTION

---

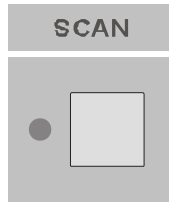

The **SCAN** key controls the cyclic motion of the attached device. The **SCAN** function allows continuous scanning of devices from one to an infinite number of cycles. The **SCAN** function begins by moving to the closest limit, then, from that point, the 2090 begins counting cycles. A cycle is defined as movement from one limit to the other and back again. The number of cycles that the device will perform is defined in parameter  $P3$ . The **SCAN** function can be terminated by pressing the SCAN button a second time (same behavior as pressing **STOP**) or by issuing any other motion command.

## USING THE STEP FUNCTIONS

---

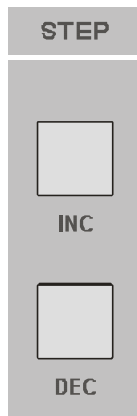

The **STEP** functions can move a device in “momentary” increments using the toggle keys under **STEP**. These keys allow “jogging” the device to a more exact position. These keys are as follows:

**INC** Moves the device up or clockwise.

**DEC** Moves the device down or counterclockwise.

The controller will move the device in the desired direction as long as the key is pressed. When the key is released, the device will stop. The corresponding motion indicators under the **POSITION** control group will light to indicate the actual motion. Under the default configuration, the **STEP** keys are not restricted by the software limits. Thus they can be used for adjusting position outside the soft limit settings during configuration. Optionally, the Model 2090 can be configured to restrict the motion to stay within the soft limits using parameter  $b l$ . This parameter also allows configuring the **STEP** keys to use a “fast stop” option on variable speed devices, which will eliminate the normal deceleration in favor of a much quicker deceleration curve. This can be used to improve the jog response of a device with a long deceleration. In addition, parameter  $S\Box$  can be used to specify a fixed speed for use by the **STEP** keys.

## CHANGING POLARIZATION

---

For towers equipped with air polarization, pressing the **POLARIZATION** key, while the current position is shown in the display, will toggle the state of the air solenoid valve in the motor base. The **HOR** or **VERT** indicator will light to indicate the state of the solenoid. If the Polarization Offset (parameter  $P4$  on a standard tower) is non-zero, the value will be added or subtracted from the current position depending on the target polarization. In moving from horizontal to vertical polarization, the value will be subtracted, since the antenna will rotate from being the offset distance above the centerline of the boom to being that distance to the side. In moving from vertical to horizontal, the value will be added to the current position.

The actual motion of the polarization mechanism is determined by various factors, including available air pressure and flow control settings on the air polarization piston cylinder. There is no feedback to indicate that the cross boom has completed the polarization cycle. The user should allow a certain amount of time for the polarization cycle to complete before continuing testing, or use visual feedback (i.e. from a camera system) to verify that the polarization operation has completed.

If the current position at the target polarization is outside the limits of the target polarization, the Model 2090 will generate a Polarization Limits Violation (**EOOE**) error and not allow the tower to polarize. As described in the configuration information, the Model 2090 provides two sets of limits, one for each polarization, designed to protect antenna elements from damage. (The Model 2090 provides

a small overshoot tolerance on this value, so, for example, a current position of 99.5 will not cause an error when switching to a polarization where the limit is 100.0.) Refer to the section on “Editing Parameters” under “Initialization” for information on checking or changing the limits for the target polarization. In addition to a difference in limits, the use of the Polarization Offset ( $P_{\text{U}}$ ) on a standard tower could make it so that the current position at the target polarization is outside the limits, even though the displayed current position is within the target limits. See above for a description of the polarization offset.

*NOTE: In order to toggle the polarization of the tower from the front panel, the display must be showing the current position, and not either limit.*

*NOTE: While the 2090 will allow the tower to be polarized while in motion, it is strongly recommended that the device only be polarized while stationary. The added stress on the tower mechanism and the antennas increases the chance of damage to both. Always insure that the applied weight and overhung load of the antenna are within the specifications of the tower prior to polarizing.*

## POLARIZATION VIOLATION AND LIMITS

---

A common source of confusion is the Polarization Limits Violation (E005) ) designed to protect antenna elements from damage. The 2090 allows the user or a program to set separate limits for horizontal and vertical polarizations. However, attempting to polarize the tower when the current position is outside the limits for the target polarization will generate a polarization violation. (The 2090 provides a small overshoot tolerance on this value, so a current position of 99.5 will not cause an error when switching to a polarization where the limit is 100.0.) Previously, there was no way to solve a polarization violation from the front panel other than to move the tower carrier and try to polarize again. The 2090 now supports a limit toggle option that allows the user to inspect and adjust the limit for the other polarization. While viewing either the upper or lower limit (by pressing the UP or DOWN buttons under LIMIT), pressing the POLARIZATION key will toggle the display to show the corresponding limit for the other polarization **without changing the tower polarization**. To indicate that the displayed value and polarization is not the current polarization, the indicator light by the **POLARIZATION** key will flash on and off. While in this state, the limit can be changed using the limit edit keys just the same as any other parameter. *In order to toggle the polarization of the tower from the front panel, the display must be showing the current position, and not either limit.*

## CHANGING SPEEDS

---

For two speed turntables, pressing the **SPEED** key will toggle the speed control relay in the motor base. The **FAST** or **SLOW** indicator will light to indicate the state of the speed relay. The actual speed set by these two positions is dependent on the turntable design.

For variable speed devices, the selection of the preset speed from the front panel is accomplished slightly differently, since the **POLARIZATION / FLOTATION / SPEED** key may have other uses. Pressing the **LOCAL** key while the Model 2090 is in local mode (and not editing a parameter) will display the currently selected preset speed ( $SPd$  1 through  $SPd$  8) in the 7-segment display. The display will remain for several seconds and then return to displaying the current position. While the speed display is visible, pressing the **INCRM** or **DECRM** keys under the **LIMIT** group will increase or decrease the speed selection by one setting. Each time the **INCRM** or **DECRM** keys are pressed, the speed display period will be extended, so it is easy to scroll up and down through the list of preset speeds. Refer to the section on “Editing Parameters” under “Initialization” for information on adjusting the preset speed values.

For a Standard Turntable with variable speed capability, (previously selected as a Variable Speed Turntable by setting  $P2 = 3$ ), the **SPEED** key also provides the ability to cycle between the eight preset speeds described above. For each press of the button, the turntable will change to the next speed setting. The **FAST** and **SLOW** polarization



indicators will light to represent the lower two bits of the speed selection in a binary fashion as shown below:

Speed 1 or 5: Both off  
Speed 2 or 6: Top on, bottom off  
Speed 3 or 7: Top off, bottom on  
Speed 4 or 8: Both on

For all devices, each speed setting has its own individual overshoot compensation value to provide proper overshoot correction for each speed selection. Thus, the Model 2090 can properly compensate for two speed devices that have different overshoot for each speed. However, the deceleration ramp control provided by variable speed devices will normally make overshoot compensation unnecessary. The device will decelerate prior to reaching the target value and creep in at the minimum speed. For these devices, it is recommended that the  $\square\square$  parameter be used to disable overshoot compensation.

*NOTE: While the 2090 will allow changing of the speed selection while the device is in motion, doing so is likely to cause targeting errors which may result in overshoot or undershoot of the target position.*

## USING AUXILIARY CONTROL FUNCTIONS

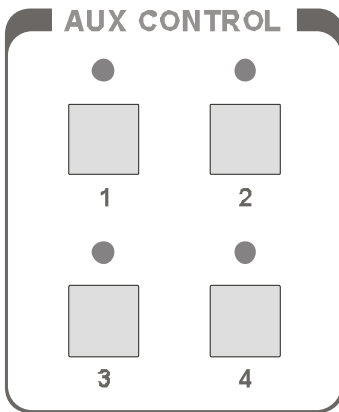

The four auxiliary control ports on the rear panel of the Model 2090 allow the connection of additional devices (for example: Remote Air Polarized Tripods, LISNs, EUTs, etc.) to the controller. The auxiliary control outputs provide four non-interrelated fiber optic ON/OFF signals that can either respond to GPIB commands when in the remote mode, or can be toggled ON and OFF from the front panel while in the manual mode.

*NOTE: The auxiliary controls can be used for custom applications requiring a simple ON/OFF signal by using readily available TTL output fiber optic receivers.*

While in manual mode, auxiliary devices may be toggled ON and OFF by pressing the **AUX CONTROL** key on the front panel of the controller that corresponds to the desired auxiliary device port. Both the keys and the ports are numbered one through four. When the indicator above the device key is lit, the auxiliary device output is turned ON. When the indicator above the device key is not lit, the auxiliary device output is turned OFF. While in remote mode, auxiliary devices can be turned ON and OFF by using the appropriate GPIB command (see “Remote Operations”). The auxiliary devices can be controlled using the GPIB address of either primary device.

## USING A BORE SIGHT TOWER

---

**To configure a Bore Sight tower, do the following:**

- Set  $P1$  to 1 ; Define device as a tower
- Set  $P2$  to 1 ; Bore Sight Tower
- Set  $P3$  to 3, 10, or 30 ; Select distance to EUT
- Set  $P5$  to 0 or 1 ; Select type of bore sight

When in Bore Sight Mode, the height reported by the Model 2090 is an adjusted height. This height is based on the carrier height, boom length, and the distance to the EUT. The shuttle height is the height that is normally reported on the Model 2090. The boom length (the distance between the pivot point and the antenna position) is always assumed to be one meter in length. The antenna position is assumed to be the location of the phase center of the antenna or whichever point is used to measure the adjusted height. The distance to the EUT is the distance in meters between the antenna position at the base point and the equipment being tested. The base point for beginning calculating the Adjusted Height is at one meter. Therefore the Bore Sight compensation is disabled under one meter.

The 2090 provides a correction lookup table for the standard 2070 series towers (6 m mast) and an alternate table for a custom tower design (5 m mast). Future firmware revisions will be made to support any other bore sight tower designs.

The following diagram shows the factors that come into being when calculating the adjusted height for a standard 2070 series tower:

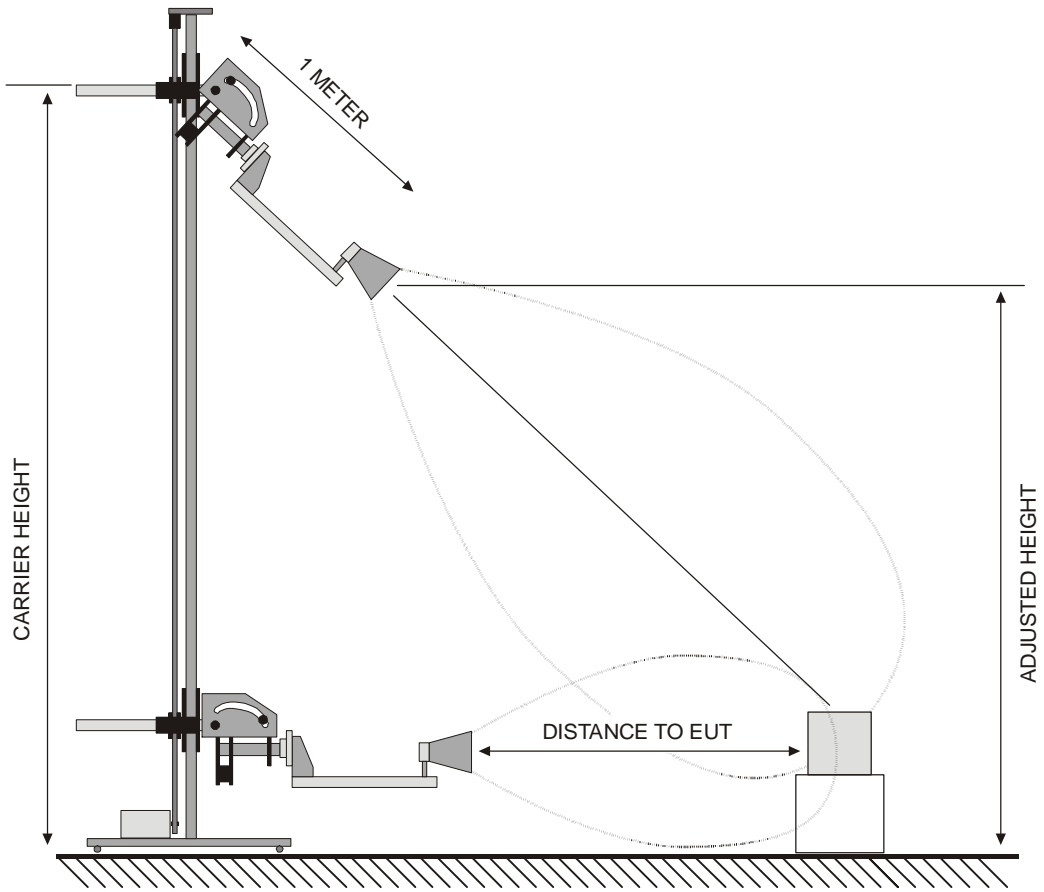

**Figure 5 Bore sight geometry for standard bore sight tower**

## USING AN AIR FLOTATION TURNTABLE

---

**To configure an Air Flotation turntable do the following:**

Set  $P1$  to 0 ; Define device as a turntable

Set  $P2$  to 1 ; Air Flotation Turntable

The Air Flotation turntable works the same as a normal turntable with one exception. This exception is the UP/DOWN feature related to the Flotation. To prevent the turntable from moving prior to the air being applied, the Model 2090 automatically causes the air to raise the turntable from the ground when a movement function is given. A three second delay is provided to ensure that turntable flotation has occurred prior to movement.

## USING A REVERBERATION PADDLE

---

**To configure a reverberation paddle do the following:**

Set  $P1$  to 0 ; Define device as a turntable

Set  $P2$  to 0 ; Standard Turntable

Set  $P5$  to 0 ; Continuous Rotation

Set  $\square$  to appropriate calibration value. See the section “Model 2090 Parameter List” for the calibration value.

ETS-Lindgren reverberation paddles (mode stirrers/tuners) operate similar to variable speed turntables, although they typically have higher rotational speeds and are used in continuous rotation mode.

---

## USING A MULTI-AXIS POSITIONER

---

**To configure a MAPS do the following for both devices:**

Set  $P1$  to 0 ; Define device as a turntable

Set  $P2$  to 0 ; Standard Turntable

Set  $C$  to appropriate calibration value. See the section “Model 2090 Parameter List” for the calibration value.

Each axis of an ETS-Lindgren Multi-Axis Positioning System is a single device on the Model 2090. Both devices should be configured as a standard turntable (the Model 2090 will automatically detect the variable speed capability of the MAPS). The main turntable base (azimuth axis) must be configured in non-continuous rotation mode, since the power and control cables for the second axis are run through the center of the first. Depending on the configuration, the ortho (elevation) axis can be continuous or non-continuous. If additional cables are used along this axis, it should be configured for non-continuous rotation.

## REMOTE OPERATIONS

---

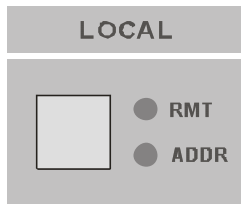

The RMT indicator under **LOCAL** on the front panel of the controller indicates that the associated device controller is in remote mode. By default, the controller is in manual mode unless given a command from a device on the GPIB bus (usually a computer with a GPIB card installed). When a command from the GPIB device is given, the RMT indicator will light and the **ADDR** indicator will light to show bus activity. It is not possible to enter remote mode by pressing the **LOCAL** key. However, pressing the **LOCAL** key while in remote mode will return the Model 2090 to local mode.

While in remote mode, it is possible to change operational parameters and initiate functions through a series of GPIB commands. A given command (for example: UP or CW) is sent from a GPIB device to the Model 2090 controller. The controller will recognize the address of the device to be controlled, and execute the required function on that device.

This page intentionally left blank.



# USING THE GPIB COMMAND SET WITH THE MODEL 2090

---

---

The ETS-Lindgren Model 2090 controller has a large command set covering all of ETS-Lindgren's past positioning controllers. The command set from the Models 1050, 1060, and 1090 are incorporated into the Model 2090 along with a variety of new commands. The Model 2090 also supports the same command set as the ETS-Lindgren Model 2190 Virtual Device Controller.

Some of the legacy commands are duplicated while others have gained new meaning. In addition, conformity to the IEEE 488.2 standard requires a more restricted interpretation of some of the commands. See "Appendix A: Model 2090 GPIB COMMAND REFERENCE" for a list of all the commands and their functions.

## BACKWARD COMPATIBILITY

---

The Model 2090 incorporates the command sets of previous ETS-Lindgren controllers. This is intended to allow pre-existing software written for older controllers to run with little or no modification with the Model 2090. The entire Model 1050 and 1060 command set has been reproduced while only a portion of the Model 1090 command set is included. The commands not implemented under the Model 1090 set are mainly those associated with the four-device control. All motion control, limit settings, and basic operations have been maintained. However, the

IEEE 488.2 standard does not allow one behavior of the older controllers. Sending a position or limit command would set up the controller to respond to all future reads with that value. The IEEE 488.2 standard requires a query/response behavior, where the returned value must be requested first. Thus, on the model 2090, all GPIB reads must be preceded by a write of the associated query command to the device. Programs designed to write the command once and read the result (usually the current position) over and over will not work without modification.

## GETTING STARTED WITH THE GPIB

---

The Model 2090 contains a single GPIB port which has been configured to accept two separate addresses. Valid addresses are in the range of 0 to 30, although 0 is typically reserved for the controller in charge (i.e. the PC). There are no criteria for setting the addresses, other than that they be different from each other, but it is recommend that the address for Device 1 be one address less than for Device 2. The default settings are 8 and 9.

*NOTE (on using the N1/N2 numeric modes): Once a mode is selected, it is effective for both devices. N1 mode is backward compatible for the older model ETS-Lindgren controllers, 1050, 1060, and 1090. This mode causes the GPIB to respond to queries with only a 3 digit value which was the maximum resolution of the older controllers. The N2 mode allows one to access the higher degree of display resolution available with the Model 2090 controller. This will give a floating-point response, XXX.X. Note that N1 is*

*the default setting. The software must issue the N2 command before floating point mode is enabled. The numeric mode is not saved in memory. Thus a program should always issue an N2 command upon startup to place the Model 2090 in floating point mode.*

## TYPICAL FLOW OF CODE:

---

1. Initialize device
  - a. Query ID string to determine model and firmware version. (Used to determine what features are supported.)
  - b. Configure status reporting if supported and desired.
  - c. Set numeric mode 2 (requests decimal point).
  - d. Verify current position is within desired limits and adjust as needed.
  - e. Set software limits as needed.
2. Set scan count, polarization, and/or any other desired motion related parameters.
3. Send GPIB command(s) for desired motion (up, down, seek, scan, etc.)
4. Wait for motion to complete.
  - a. Monitor current position as required.
  - b. Check for operation complete.
  - c. Repeat until motion complete.
5. Repeat step 3-4 until test is complete.
6. Stop all devices.

*NOTE: All sample code is written in Visual Basic using the National Instruments GPIB card. This code is intended for illustration purposes only. EMC Test Systems, L.P. makes no claim as to its suitability for any other purpose.*

## CODE SAMPLE 1

The following code segment gives a brief example of the scan function implemented using Visual Basic. It will set the limits of both a tower and turntable, set them both for infinite scan count, initiate scan mode on both devices, and monitor the current position for ten seconds.

```

ibdev 0, 8, 0, T10s, 1, &HCOA, Tower% ' Initialize GPIB interface
ibdev 0, 9, 0, T10s, 1, &HCOA, Table%

ibwrt Tower%, "LL 100"           ' Set lower limit to 100 cm
ibwrt Tower%, "UL 400"           ' Set upper limit to 400 cm
ibwrt Tower%, "CY 000"           ' Set infinite scan count
ibwrt Table%, "CL 0"             ' Set CCW limit to 0 degrees
ibwrt Table%, "WL 359"           ' Set CW limit to 359 degrees
ibwrt Table%, "CY 000"           ' Set infinite scan count

ibwrt Tower%, "SC"               ' Scan tower
ibwrt Table%, "SC"               ' Scan turntable

For Counter = 0 To 100           ' Read position 100 times
  ibwrt Tower%, "CP?"            ' Query tower current position
  Read$ = Space$(20)             ' Initialize buffer to 20 bytes
  ibrd Tower%, Read$             ' Read response
  TowerEdit.Text = Val(Read$)     ' Display number in edit box
  ibwrt Table%, "CP?"            ' Query turntable current position
  Read$ = Space$(20)             ' Initialize buffer to 20 bytes
  ibrd Table%, Read$             ' Read response
  TableEdit.Text = Val(Read$)     ' Display number in edit box
  StartTime = Timer              ' Read current timer count
  While (Timer < StartTime + 0.1) ' Delay 0.1 second
    DoEvents                      ' Let Windows do other things
  Wend
Next                               ' Loop for about 10 seconds

ibwrt Tower%, "ST"               ' Stop tower
ibwrt Table%, "ST"               ' Stop turntable
ibonl Tower%, 0                  ' Free tower's GPIB port
ibonl Table%, 0                  ' Free turntable's GPIB port

```

Note the 0.1 second delay between readings of the devices. The Model 2090 updates the available position information ten times per second, so GPIB queries faster than this rate will return the same information and are simply a waste of processor time. Since the Model 2090 is capable of seeking a target position without intervention of a

controlling program, the only reason a program needs to check the current position is to update a position display for the user. The user cannot possibly respond to data faster than ten times a second.

## CODE SAMPLE 2

---

This code segment is significantly more advanced. It uses the \*OPC? command to determine when a device has quit moving and takes into account possible problems due to overshoot and undershoot. This program performs a complete pre-compliance scan, with both horizontal and vertical polarizations.

```
Dim TowerDone As Boolean, TableDone As Boolean
Dim Angle As Integer, StartTime As Single
Dim LastPosition As Single, UpperVertLim As Single
Dim Read$

'
' Initialize the tower and turntable
'

ibdev 0, 8, 0, T10s, 1, &HCOA, Tower% ' Initialize GPIB interface
ibdev 0, 9, 0, T10s, 1, &HCOA, Table%

'
' Set 2090 numeric mode and Upper/CW and Lower/CCW limits for both devices
' Note the use of semicolons to combine commands on one line
'

ibwrt Tower%, "N2;LL 100;UL 400"      ' Set limits to 100 cm & 400 cm
ibwrt Table%, "N2;CL 0;WL 359"       ' Set limits to 0 & 359 degrees
UpperVertLim = 380                  ' Set upper vertical limit to 380 cm
                                     ' (Used later in program)

'
' Send both devices to their lower limits and wait until complete
'

ibwrt Tower%, "DN"                  ' Send the tower to the bottom
ibwrt Table%, "CC"                  ' Send the turntable to zero
TowerDone = False                   ' Initialize flags
TableDone = False
Read$ = Space$(20)                  ' Initialize buffer

Do                                  ' Update display while waiting
  ibwrt Tower%, "CP?"               ' Query tower current position
  ibrd Tower%, Read$                ' Read response
  TowerEdit.Text = Val(Read$)       ' Display number in edit box
```

```

ibwrt Table%, "CP?"           ' Query turntable current position
ibrd Table%, Read$           '
TableEdit.Text = Val(Read$)  '
StartTime = Timer            ' Read current timer count
While (Timer < StartTime + 0.1) ' Delay 0.1 second
  DoEvents                   ' Let Windows do other things
Wend
If (Not TowerDone) Then
  ibwrt Tower%, "*OPC?"      ' Is the tower done moving?
  ibrd Tower%, Read$         ' Read response
  TowerDone = Val(Read$)     ' =1 if done, 0 if moving
End If
If (Not TableDone) Then
  ibwrt Table%, "*OPC?"     ' Is the turntable done moving?
  ibrd Table%, Read$        ' Read response
  TableDone = Val(Read$)    ' =1 if done, 0 if moving
End If
DoEvents                     ' Let Windows do other things
Loop While Not (TowerDone And TableDone) ' Until both devices stop

ibwrt Tower%, "UV " + Str$(UpperVertLim) ' Set upper vertical limit

Angle = 0

While (Angle < 360)
  '
  ' Polarize the tower horizontally, after insuring that it is above
  ' the lower limit. (There is a one cm tolerance for polarization
  ' violation, so we must be sure we're within that value or we'll
  ' cause an error when we try to polarize.)
  '
  ibwrt Tower%, "CP?"       ' Query tower current position
  ibrd Tower%, Read$        ' Read response
  LastPosition = Val(Read$) ' Save this position

  While LastPosition < 99
    ibwrt Tower%, "SK 100"  ' Send the tower up to the lower limit
    Do
      ibwrt Tower%, "CP?"   ' Query tower current position
      ibrd Tower%, Read$    ' Read response
      TowerEdit.Text = Val(Read$) ' Display number in edit box
      StartTime = Timer    ' Read current timer count
      While (Timer < StartTime + 0.1) ' Delay 0.1 second
        DoEvents           ' Let Windows do other things
      Wend
      ibwrt Tower%, "*OPC?" ' Is the tower done moving?
      ibrd Tower%, Read$    ' Read response
      TowerDone = Val(Read$) ' =1 if done, 0 if moving
    Loop While Not TowerDone ' Until tower stops

    ibwrt Tower%, "CP?"     ' Query tower current position
    ibrd Tower%, Read$     ' Read response
    LastPosition = Val(Read$) ' Save this value
    TowerEdit.Text = LastPosition ' Display number in edit box
  Wend

  '
  ' Change polarization to horizontal
  '

  TowerEdit.Text = "Polarizing" ' Inform user of tower status
  ibwrt Tower%, "PH"           ' Polarize Horizontal

```

```
StartTime = Timer           ' Read current timer count
While (Timer < StartTime + 3) ' Delay at least 3 sec for polarization
  DoEvents                 ' Let Windows do other things
Wend

'
' Set up spectrum analyzer for max hold for horizontal scan here...
'
' Scan tower up with tower polarized horizontally
'
ibwrt Tower%, "UP"         ' Send tower to top
Do                          ' Update display while waiting
  ibwrt Tower%, "CP?"     ' Query tower current position
  ibrd Tower%, Read$      ' Read response
  TowerEdit.Text = Val(Read$) ' Display number in edit box
  '
  ' Update analyzer display here...
  '
  StartTime = Timer       ' Read current timer count
  While (Timer < StartTime + 0.1) ' Delay 0.1 second
    DoEvents              ' Let Windows do other things
  Wend
  ibwrt Tower%, "*OPC?"   ' Is the tower done moving?
  ibrd Tower%, Read$      ' Read response
  TowerDone = Val(Read$)  ' =1 if done, 0 if moving
Loop While Not TowerDone  ' Until tower stops

ibwrt Tower%, "CP?"       ' Query tower current position
ibrd Tower%, Read$        ' Read response
TowerEdit.Text = Val(Read$) ' Display number in edit box

'
' Move tower to vertical polarization upper limit before attempting
' to change polarization. (There is a one cm tolerance for polariz-
' ation violation, so we must be sure we're within that value or
' we'll cause an error when we try to polarize)
'
Do
  ibwrt Tower%, "SK " + Str$(UpperVertLim) ' Move twr to upr vert lim

  Do
    ibwrt Tower%, "CP?" ' Update display while waiting
    ibrd Tower%, Read$  ' Query tower current position
    TowerEdit.Text = Val(Read$) ' Read response
    TowerEdit.Text = Val(Read$) ' Display number in edit box
    StartTime = Timer    ' Read current timer count
    While (Timer < StartTime + 0.1) ' Delay 0.1 second
      DoEvents          ' Let Windows do other things
    Wend
    ibwrt Tower%, "*OPC?" ' Is the tower done moving?
    ibrd Tower%, Read$    ' Read response
    TowerDone = Val(Read$) ' =1 if done, 0 if moving
  Loop While Not TowerDone ' Until tower stops

  ibwrt Tower%, "CP?" ' Query tower current position
  ibrd Tower%, Read$  ' Read response
  LastPosition = Val(Read$) ' Save this value
  TowerEdit.Text = LastPosition ' Display number in edit box
Loop While (LastPosition > UpperVertLim + 1) ' Undershot target, retry

'
' Change polarization to vertical
'
```

```

TowerEdit.Text = "Polarizing"      ' Inform user of tower status
ibwrt Tower%, "PV"                 ' Polarize Vertical

StartTime = Timer                  ' Read current timer count
While (Timer < StartTime + 3)     ' Delay 3 sec for polarization
  DoEvents                         ' Let Windows do other things
Wend

ibwrt Tower%, "CP?"               ' Query tower current position
ibrd Tower%, Read$                ' Read response
TowerEdit.Text = Val(Read$)       ' Display number in edit box

'
' Set up spectrum analyzer for max hold for vertical scan here...
'
' Scan tower down with tower polarized vertically
'
ibwrt Tower%, "DN"                 ' Send tower to bottom
Do                                  ' Update display while waiting
  ibwrt Tower%, "CP?"              ' Query tower current position
  ibrd Tower%, Read$              ' Read response
  TowerEdit.Text = Val(Read$)     ' Display number in edit box
'
' Update analyzer display here...
'
StartTime = Timer                  ' Read current timer count
While (Timer < StartTime + 0.1)   ' Delay 0.1 second
  DoEvents                         ' Let Windows do other things
Wend
ibwrt Tower%, "*OPC?"             ' Is the tower done moving?
ibrd Tower%, Read$                ' Read response
TowerDone = Val(Read$)            ' =1 if done, 0 if moving
Loop While Not TowerDone          ' Until tower stops

'
' Move turntable to next angle position
'

Angle = Angle + 90                ' Set the new angle
ibwrt Table%, "SK " + Str$(Angle) ' And turn the table to it

Do                                  ' Wait until table finishes moving
  ibwrt Table%, "CP?"              ' Query turntable current position
  ibrd Table%, Read$              ' Read response
  TableEdit.Text = Val(Read$)     ' Display number in edit box
  StartTime = Timer               ' Read current timer count
  While (Timer < StartTime + 0.1) ' Delay 0.1 second
    DoEvents                       ' Let Windows do other things
  Wend
  ibwrt Table%, "*OPC?"           ' Is the turntable done moving?
  ibrd Table%, Read$              ' Read response
  TableDone = Val(Read$)          ' =1 if done, 0 if moving
Loop While Not TableDone          ' Until turntable stops

ibwrt Table%, "CP?"               ' Query turntable current position
ibrd Table%, Read$                ' Read response
TableEdit.Text = Val(Read$)       ' Display number in edit box

Wend

'
' Clean up before quitting

```



```

ibwrt Tower%, "ST"           ' Stop tower
ibwrt Table%, "ST"          ' Stop turntable
ibonl Tower%, 0              ' Free tower's GPIB port
ibonl Table%, 0              ' Free turntable's GPIB port

```

Note the use of semicolons to combine more than one GPIB command on the same line. Any string of commands can be combined, but only the last query command in the string will be returned for a read. Motion commands will be performed in order just as they would if sent separately. Thus sending "UP;DN" would start the device in the up direction and immediately reverse to the down direction. Sending "UP;\*WAI;DN" *would* cause the Model 2090 to go to the upper limit and then go down to the lower limit once there, but since the \*WAI command halts all GPIB command activity until the current motion is complete, it is not possible to monitor the current position or anything else while the device is in motion. For this reason, the \*OPC? command (or other related commands) is recommended for this purpose.

Refer to the programming example in the next section for more advanced programming options, including the use of subroutines to reduce the size of program code.

---

## GPIB STATUS REPORTING

---

The Model 2090 supports the ANSI/IEEE 488.2 Standard Interface Protocols for GPIB interfaces. As such, it is capable of reporting various device status conditions and requesting service over the GPIB. When used properly, these capabilities allow programmers to develop powerful applications that can handle almost any condition the controller may encounter.

The status reporting method centers around a set of binary registers whose bits are logical flags which indicate the status of various instrument states and error conditions. Each status register is associated with an enable register which allows the user (program) to configure which status flags will generate requests for service from the controller. The primary status register is the Status Byte Register. If the bits of this register, when logically ANDed with the bits of the Service Request Enable Register, are non-zero, a Service Request (SRQ) is issued to the Controller-in-Charge (CIC) of the GPIB (that is normally the computer running a program). Each bit of the Status Byte Register indicates the status of other status registers and their enable registers, as well as certain queues. These registers include the Standard Event Status Register, the Device Dependent Error Register, and the Output Queue. Refer to “Appendix A, Model 2090 GPIB Command Reference”, for more details on each of these registers. The format of these registers is laid out in the following figure:

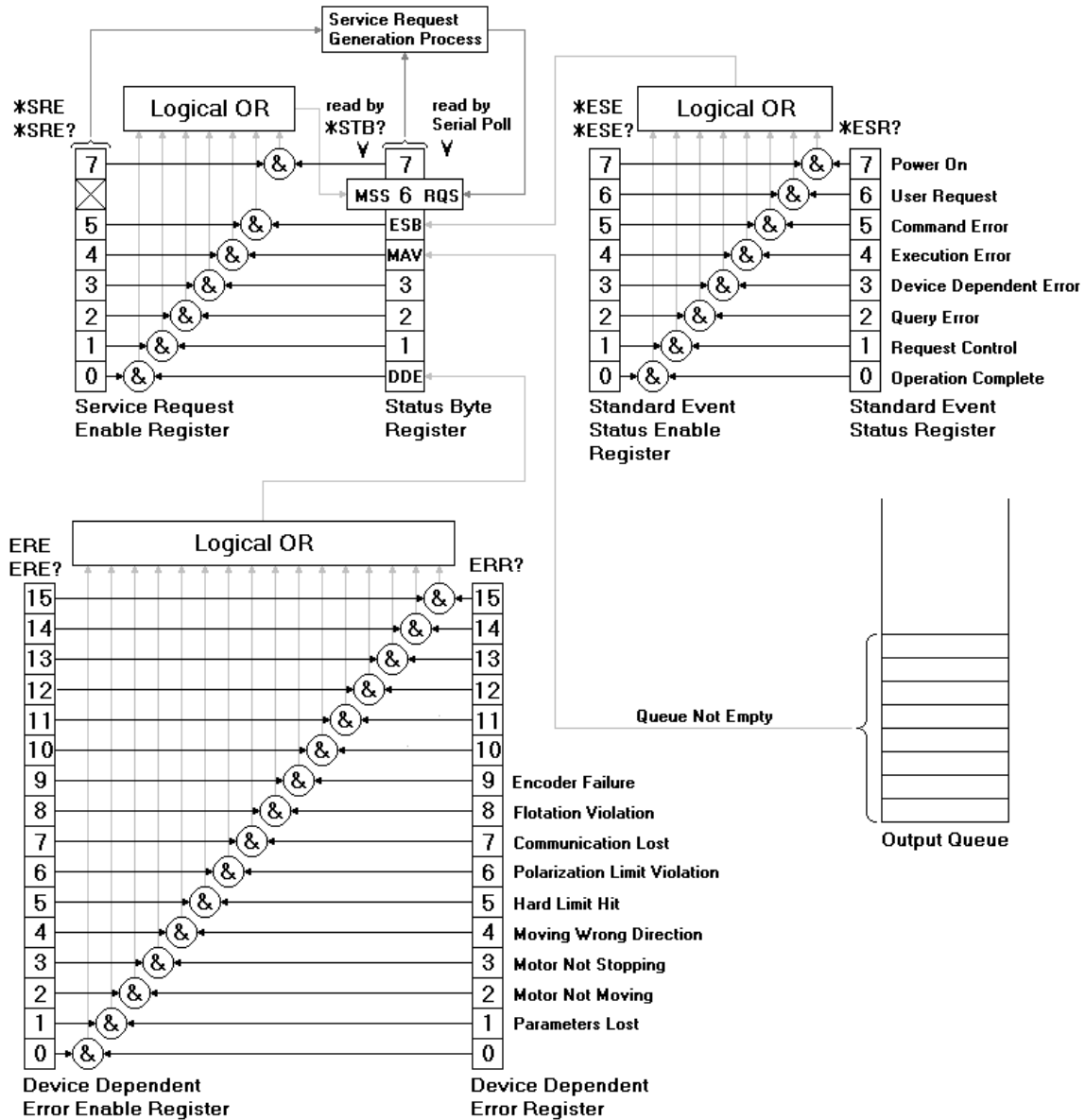

**Figure 6 Status Reporting Model**

The **Service Request Enable Register** allows the bits of the Status Byte Register to generate a Service Request. The bit pattern of this register corresponds to that of the Status Byte Register. A Service Request is generated any time one of the bits in the Status Byte Register makes a transition from FALSE to TRUE while the corresponding bit in the Service Request Enable Register is TRUE. A Service Request will also be generated if a bit in the Status

Byte Register is TRUE and the corresponding bit in the Service Request Enable Register makes a transition from FALSE to TRUE due to a command from the controlling program. The \*SRE GPIB command is used to set the value of the register and the \*SRE? command is used to query the current setting.

The **Status Byte Register** is the heart of the status reporting system. All other status registers and queues are represented here. This register has the ability to generate a service request, allowing the controller to inform the controlling program that a condition exists which needs attention. The value of the Status Byte Register can be read either by issuing the \*STB? command or by performing a Serial Poll. When reading the register using \*STB?, bit six returns the Master Summary Status (MSS) bit. When reading the register using a Serial Poll, bit six returns the value of the Request Service (RQS) flag. The following table gives a description of each bit.

<b>Bit</b>	<b>Name</b>	<b>Description</b>
0	- Device Dependent Error (DDE)	Set when the logical AND of the Device Dependent Error Register and the Device Dependent Error Enable Register is non-zero. This is a 2090/2190 specific status bit.
1	- Undefined	
2	- Undefined	
3	- Undefined	
4	- Message Available (MAV)	Set when there is data in the device output queue waiting to be read over the GPIB.
5	- Event Status Bit (ESB)	Set when the logical AND of the Event Status Register and the Event Status Enable Register is non-zero.
6	- Master Summary	Set when the logical AND of the

Status (MSS)	remaining bits of the Status Byte Register and the Status Byte Enable Register is non-zero. This value is returned in response to a *STB? query.
-or-	
Request Service (RQS)	Set when a Service Request has been generated (when the controller's GPIB SRQ line is asserted). This value is returned in response to a Serial Poll.
<hr/>	
7 - Undefined	

A GPIB device informs the controlling program of a condition which needs attention by issuing a **Service Request**. It does so by asserting the SRQ line of the IEEE 488 bus. The controlling program can then detect that the SRQ line has been asserted and perform a Serial Poll to determine which device or devices are requesting service. If a device is requesting service, bit six of the Serial Poll Response Byte will be TRUE, otherwise it will be FALSE. The remaining bits of the Response Byte are the bits of the Status Byte Register. Upon performing a Serial Poll, the SRQ line will be unasserted to allow other devices to request service. The RQS (Request Service) flag is TRUE as long as the SRQ line is asserted.

A Service Request is generated any time one of the bits in the Status Byte Register makes a transition from FALSE to TRUE while the corresponding bit in the Service Request Enable Register is TRUE. A Service Request will also be generated if a bit in the Status Byte Register is TRUE and the corresponding bit in the Service Request Enable Register makes a transition from FALSE to TRUE due to the use of the \*SRE GPIB command.

The **Serial Poll Response Byte** is the value returned to the controlling program in response to a Serial Poll of the GPIB bus. The value of the response is the value of the Status Byte Register of the polled device where bit six is the value of the RQS (Request Service) flag.

A **Serial Poll** is a GPIB command issued by the controlling program to request that a device on the GPIB bus return the value of its Status Byte Register. The Serial Poll is used to respond to a Service Request from a device on the GPIB bus.

The **Device Dependent Error Enable Register** allows the bits of the Device Dependent Error Register to set the DDE bit of the Status Byte Register. The bit pattern of this register corresponds to that of the Device Dependent Error Register. The DDE bit of the Status Byte Register will be TRUE whenever any of the bits in the Device Dependent Error Register and the corresponding bit in the Device Dependent Error Enable Register are both TRUE. Otherwise, the DDE bit is FALSE. The ERE GPIB command is used to set the value of the register and the ERE? command is used to query the current setting.

The **Device Dependent Error Register** is used to report motion errors or other problems detected by the Model 2090 Multi-Device Controller. The bit pattern of this register corresponds to the front panel errors reported by the Model 2090 and is defined as follows:

<b>Bit</b>	<b>Name</b>	<b>Description</b>
1	- Parameters Lost	Set at startup if the Model 2090 detects that previous settings have been lost
2	- Motor Not Moving	Indicates a device stuck condition. The controller automatically generates a STOP condition to protect the motor.
3	- Motor Not Stopping	Indicates that the device failed to stop moving when commanded.
4	- Moving Wrong Direction	Indicates that the device moved in the opposite direction of that commanded.
5	- Hard Limit Hit	Indicates that the device is unable to move because it is at a hardware limit.
6	- Polarization Limit Violation	Indicates that the tower was told to change polarization while it was outside the position limits specified for the new polarization.
7	- Communication Lost	Indicates that the controller is unable to communicate with the device over the fiber optic link.
8	- Flotation Violation	Indicates that an air flotation turntable was told to turn flotation off while it was moving.
9	- Encoder Failure	Indicates that the Model 2090 has detected device encoder behavior consistent with a fault in the encoder, its wiring, or connections.
10	- Trigger Failure	This error indicates that the Model 2090 has detected an overflow in the trigger queue register.
11	- Overheat	This error indicates that the Model 2090 has detected that either the motor or control board has exceeded the corresponding maximum temperature.
12	- Relay Failure	This error indicates that the Model 2090 has detected the motor drive relays are not switching properly.

The remaining bits are undefined. Refer to “Appendix B: Model 2090 Error Code Reference” for more information on troubleshooting error conditions.

As long as bits are set in this register, any commands related to device motion or position settings will generate an execution error. See the “Standard Event Status Register” information on the next page.

The **Standard Event Status Enable Register** allows the bits of the Standard Event Status Register to set the ESB bit of the Status Byte Register. The bit pattern of this register corresponds to that of the Standard Event Status Register. The ESB bit of the Status Byte Register will be TRUE whenever any of the bits in the Standard Event Status Register and the corresponding bit in the Standard Event Status Enable Register are both TRUE. Otherwise, the ESB bit is FALSE. The ESE GPIB command is used to set the value of the register and the ESE? command is used to query the current setting.

The **Standard Event Status Register** is an IEEE 488 Standard Register which reports various device events and error conditions. The bit pattern of this register is as follows:

<b>Bit</b>	<b>Name</b>	<b>Description</b>
0	- Operation Complete	Set when the Operation Complete has been armed by issuing *OPC and the device motion has stopped.
1	- Request Control	Unused. The Model 2090 does not have controller capability
2	- Query Error	Set when an attempt is made to read from the output queue when it is empty.
3	- Device Dependent Error	Set when a device dependent error occurs, regardless of the ERE value. These errors correspond to front panel error conditions.
4	- Execution Error	Set when a valid GPIB command is received with parameters that are out of



---

	range, or when a device dependent error prevents execution of the command.
5 - Command Error	Set when an invalid GPIB command is received by the controller
6 - User Request	Unused. The Model 2090 does not support user request functions.
7 - Power On	Set when the Model 2090 is first powered on.

---

The **Output Queue** is the buffer which holds information to be returned over the GPIB when a read command is performed. As long as there is information in the Output Queue, the MAV (Message Available) bit of the Status Byte Register will be set.

<b>Logical OR</b>
-------------------

This symbol represents a logical OR of all of the input bits. As long as any one of the input bits is TRUE, the output will be TRUE. If all of the input bits are FALSE, the output will be FALSE.

- ⊗ These symbols represent a logical AND of the bits of the two registers. If a given bit from both registers is TRUE then the corresponding output is TRUE. If either bit is FALSE then the output is FALSE.

The following section of program code and subroutines illustrates the use of the GPIB status reporting system to detect a number of error conditions on a standard tower. Note the use of subroutines to create modified versions of the commands "ibrd" and "ibwrt" which handle the generation of a service request. This concept can be extended to provide subroutines which handle service requests from any GPIB call. There are also subroutines for handling basic functions of the Model 2090. By breaking up the program in this manner it is possible to handle any condition with ease while at the same time reducing the size of the program code.

```

Read$ = Space$(50)
'
' Initialize the tower
'
ibdev 0, 8, 0, T10s, 1, &HC0A, Tower% ' Initialize GPIB interface
'
' Make sure this controller supports full error event handling
'
ibwrt Tower%, "*IDN?"                ' Query the identification string
ibrd Tower%, Read$                  ' Read response

If (InStr(Read$, 2190) = 0) Then      ' Not a 2190 (all 2190's support full
                                     ' error event handling)
    If (InStr(Read$, 2090) = 0) Then  ' Not a 2090!
        MsgBox "The device is not a 2090 controller!", 0, "Error"
        ibonl Tower%, 0                ' Free tower's GPIB port
        Exit Sub
    Else
        Read$ = Mid$(Read$, InStr(Read$, "REV") + 3, 5) ' Get version number
        If (Val(Read$) < 2.3) Then
            Msg$ = "This 2090 has firmware version " + Str$(Val(Read$)) + "." + Chr$(13)
            Msg$ = Msg$ + "Full error event handling was implemented in version 2.3." + Chr$(13)
            Msg$ = Msg$ + "Contact the EMCO sales department for a firmware upgrade."
            MsgBox Msg$, 0, "Invalid Firmware Version"
            ibonl Tower%, 0            ' Free tower's GPIB port
            Exit Sub
        End If
    End If
End If

'
' Set up event handling registers.
'
ibwrt Tower%, "*CLS"                ' Clear any previous conditions
ibwrt Tower%, "*SRE 33"              ' Allow ESB and DDE to generate SRQ
ibwrt Tower%, "*ESE 52"              ' Command, Execution, & Query errors
ibwrt Tower%, "ERE 511"              ' All defined Device Dependent errors
'
' Set 2090 numeric mode and Upper and Lower limits for tower
'

ibwrite Tower%, "N2;LL 100;UL 400"  ' Set limits to 100 cm & 400 cm
'
' Note the use of commands "ibwrite" and "ibread" instead of "ibwrt" and "ibrd"
' If an error is generated by the controller, these routines will detect it and
' display an error message for the user.
'

SeekPosition 150, Tower%, TowerEdit ' Move to 150.0 cm
'
' Note the use of subroutines to perform certain tasks
'
' Generate a Polarization Violation Error
'
TowerEdit.Text = "Polarizing"        ' Inform user of tower status
ibwrite Tower%, "PH"                 ' Polarize horizontal

```

```

ibwrite Tower%, "LV 200"           ' Set lower vertical limit
TowerEdit.Text = "Polar Violation" ' Inform user of status
ibwrite Tower%, "PV"               ' Generate Polarization Violation
                                   ' Error by polarizing vertically

'
'   Generate an Execution Error
'
TowerEdit.Text = "Execution Error" ' Inform user of status
ibwrite Tower%, "UL 50"           ' Setting upper limit < lower limit
                                   ' will cause an execution error

'
'   Generate a Command Error
'
TowerEdit.Text = "Command Error"   ' Inform user of status
ibwrite Tower%, "Bad command"     ' Generate a Command Error

'
'   Generate a Query Error
'
ibtmo Tower%, T100ms              ' Reduce the GPIB timeout
TowerEdit.Text = "Query Error"    ' Inform user of status
ibread Tower%, Read$              ' Generate Query Error by reading
                                   ' from the controller when it has
                                   ' nothing to say.

TowerEdit.Text = GetCurrentPosition(Tower%) ' Show current position

'
'   Clean up before quitting
'

ibwrite Tower%, "ST"              ' Stop tower
ibonl Tower%, 0                   ' Free tower's GPIB port

'
'   This function will return the current position of the specified device.
'
Function GetCurrentPosition(device%) As Single
    Dim Read$
    Read$ = Space$(20)             ' Initialize a buffer
    ibwrite device%, "CP?"        ' Query device current position
    ibread device%, Read$         ' Read response
    GetCurrentPosition = Val(Read$) ' Return value
End Function

'
'   This function handles service requests detected during reads.
'   The GPIB card must be configured for Auto Serial Polls in order
'   for this function to work properly.
'
Sub ibread(device%, data$)
    ibrd device%, data$           ' Read data from the GPIB port
    If (ibsta And RQS) Then ServiceRequest device% ' Handle any request for service
End Sub

```

```

'
' This function handles service requests detected during writes.
' The GPIB card must be configured for Auto Serial Polls in order
' for this function to work properly.
'
Sub ibwrite(device%, data$)
    ibwrt device%, data$                ' Write data to GPIB port
    If (ibsta And RQS) Then ServiceRequest device% ' Handle any request for service
End Sub

'
' This function performs a seek to reach a particular position.
' It waits until the seek is completed and updates the display.
' It will attempt to get within one cm/degree of the target value
' and retry up to five times if it fails.
'
Sub SeekPosition(Position As Single, device%, DeviceEdit)

    Dim count As Integer

    count = 0

    While count < 5
        ibwrite device%, "SK " + Str$(Position)    ' Send seek command
        WaitForStop device%, DeviceEdit           ' Wait for completion of seek
        If Abs(GetCurrentPosition(device%) - Position) < 1 Then Exit Sub
        count = count + 1
    Wend

    MsgBox "The device failed to reach its target position after five tries.", 0, "Seek Error"

'
' Note that code could be added to this routine to handle any errors
' generated (such as trying to seek outside of the current limits)
'
End Sub

'
' This function responds to a service request by performing a serial poll of
' the affected device and then determining and reporting the cause of the
' service request. This process also clears the error condition from the
' controller.
'
Sub ServiceRequest(device%)
    Read$ = Space$(20)
    ibrsp device%, spr%                ' Serial poll the device to clear RQS
                                        ' and determine what caused the SRQ

    If (spr% And 32) Then                ' A bit in the Event Status Register is set
        ibwrt device%, "*ESR?"          ' Query the Event Status Register
        ibrd device%, Read$             ' Read response
        ESR = Val(Read$)                ' And get value

        If (ESR And 32) Then              ' Command Error
            Msg$ = "The previous command was invalid. This error" + Chr$(13)
            Msg$ = Msg$ + "is normally caused by a mistake in the program."
        End If
    End If
End Sub

```

```

    MsgBox Msg$, 0, "Command Error"
End If
If (ESR And 16) Then
    ' Execution Error
    Msg$ = "The previous command had an invalid argument," + Chr$(13)
    Msg$ = Msg$ + "or a device dependent error condition prevented" + Chr$(13)
    Msg$ = Msg$ + "the command from being executed. Advanced" + Chr$(13)
    Msg$ = Msg$ + "programming techniques can avoid this error."
    MsgBox Msg$, 0, "Execution Error"
End If
If (ESR And 4) Then
    ' Query Error
    Msg$ = "The controller was addressed to talk with nothing," + Chr$(13)
    Msg$ = Msg$ + "to say. Either there is a mistake in the program" + Chr$(13)
    Msg$ = Msg$ + "or some other GPIB problem or error condition exists."
    MsgBox Msg$, 0, "Query Error"
End If
End If

If (spr% And 1) Then
    ' A bit in the Device Dependent Error
    ' Register is set
    ibwrt device%, "ERR?"
    ' Query the DDE Register
    ibrd device%, Read$
    ' Read response
    DDE = Val(Read$)
    ' And get value

    If (DDE And 2) Then
        ' Parameters Lost
        Msg$ = "The controller reported that it has lost its" + Chr$(13)
        Msg$ = Msg$ + "settings since the last time it was powered on."
        MsgBox Msg$, 0, "Parameters Lost"
    End If
    If (DDE And 4) Then
        ' Motor Not Moving
        Msg$ = "The controller reported that the motor is stuck."
        MsgBox Msg$, 0, "Motor Not Moving"
    End If
    If (DDE And 8) Then
        ' Motor Not Stopping
        Msg$ = "The controller reported that the motor isn't stopping."
        MsgBox Msg$, 0, "Motor Not Stopping"
    End If
    If (DDE And 16) Then
        ' Moving Wrong Direction
        Msg$ = "The controller reported that the motor is moving" + Chr$(13)
        Msg$ = Msg$ + "in the wrong direction. This is a hardware error."
        MsgBox Msg$, 0, "Moving Wrong Direction"
    End If
    If (DDE And 32) Then
        ' Hard Limit Hit
        Msg$ = "The controller reported that the device has" + Chr$(13)
        Msg$ = Msg$ + "hit a hardware limit. The user must adjust either" + Chr$(13)
        Msg$ = Msg$ + "the software limit/position settings or the hardware" + Chr$(13)
        Msg$ = Msg$ + "limit switches. A continuous rotation turntable" + Chr$(13)
        Msg$ = Msg$ + "should have its hardware limits disabled."
        MsgBox Msg$, 0, "Hard Limit Hit"
    End If
    If (DDE And 64) Then
        ' Polarization Limit Violation
        Msg$ = "The controller reported that an attempt was made" + Chr$(13)
        Msg$ = Msg$ + "to change polarization while the tower was outside" + Chr$(13)
        Msg$ = Msg$ + "the limit settings for the new polarization. The tower" + Chr$(13)
        Msg$ = Msg$ + "did not change polarization. This error can be handled" + Chr$(13)
        Msg$ = Msg$ + "without user intervention by a 'smart' program which is" + Chr$(13)
        Msg$ = Msg$ + "designed to check current position and limits to insure" + Chr$(13)
        Msg$ = Msg$ + "that the tower is within limits before polarization."
        MsgBox Msg$, 0, "Polarization Limit Violation"
    End If
    If (DDE And 128) Then
        ' Communication Lost
        Msg$ = "The controller has lost communication with the motor base." + Chr$(13)
        Msg$ = Msg$ + "Check fiber optic cables and power connections."
        MsgBox Msg$, 0, "Communication Lost"
    End If

```

```

End If
If (DDE And 256) Then          'Flotation Violation
    Msg$ = "The controller reported that an attempt was made" + Chr$(13)
    Msg$ = Msg$ + "to disengage flotation while the air flotation turntable" + Chr$(13)
    Msg$ = Msg$ + "was moving. The turntable completes the previous operation" + Chr$(13)
    Msg$ = Msg$ + "but will not accept new commands until the error is cleared." + Chr$(13)
    MsgBox Msg$, 0, "Flotation Violation"
End If

Msg$ = "Checking the error conditions automatically clears them." + Chr$(13)
Msg$ = Msg$ + "With the exception of Polarization Limit Violation and" + Chr$(13)
Msg$ = Msg$ + "Flotation Violation errors, which can be handled by a" + Chr$(13)
Msg$ = Msg$ + "'smart' program, the program should prompt the user to" + Chr$(13)
Msg$ = Msg$ + "correct the error condition before proceeding. In the" + Chr$(13)
Msg$ = Msg$ + "case of a Communication Lost error, the error message" + Chr$(13)
Msg$ = Msg$ + "will continue to be generated as long as the condition" + Chr$(13)
Msg$ = Msg$ + "exists and position related commands are being issued" + Chr$(13)
Msg$ = Msg$ + "to the controller" + Chr$(13)
MsgBox Msg$, 0, "Note on Status Reporting"
End If
End Sub

'
' This function will use the *OPC? command to determine that the given
' device has completed its motion. It will also update the given
' display during this period.
'
Sub WaitForStop(device%, DeviceEdit)

    Dim Done As Boolean, LastPosition As Single, CurrentPosition As Single
    Dim StartTime As Single
    Dim Read$

    Read$ = Space$(20)          ' Create a buffer for reads

    '
    ' Wait for operation complete
    '

    Do                          ' Update display while waiting
        DeviceEdit.Text = GetCurrentPosition(device%) ' Display current posn
        StartTime = Timer        ' Read current timer count
        While (Timer < StartTime + 0.1) ' Delay 0.1 second
            DoEvents            ' Let Windows do other things
        Wend
        ibwrite device%, "*OPC?" ' Is the device done moving?
        ibread device%, Read$    ' Read response
        Done = Val(Read$)       ' =1 if done, 0 if moving
    Loop While Not Done        ' Until device stops

    DeviceEdit.Text = GetCurrentPosition(device%) ' Display current posn
End Sub

```

This page intentionally left blank.



# APPENDIX A: MODEL 2090 GPIB COMMAND REFERENCE

---

---

The following is a complete GPIB command reference for the Model 2090 Virtual Controller.

## General Notes:

- All parameters should be separated by a white space.
- 1050, 1060 compatibility refers to commands backward compatible with Models 1050 and 1060.
- 1090, 2090 compatibility refers to commands backward compatible with the Model 1090 and compatible with the Model 2090/2190 command set.
- 2090 compatibility refers to commands that are only compatible with the Model 2090/2190.
- To access the expanded display accuracy of the Model 2090 the software should issue an N2 command.
- GPIB COMMANDS MUST TERMINATE WITH NL, EOI, OR BOTH.

Items in <parameter> are required. Items in [options] are optional.

## All GPIB examples assume:

Device 1 -- Standard Tower

GPIB Address: 8  
Device Type: TWR NRM  
Initialization: CALL ibdev(0, 8, 0, T10s, 1, &HC0A, TowerUD%)

Device 2 -- Standard Turntable

GPIB Address: 9  
Device Type: TT NRM  
Initialization: CALL ibdev(0, 9, 0, T10s, 1, &HC0A, TableUD%)

All examples are in Visual Basic format. Refer to the National Instruments NI-488.2 Function Reference Manual for DOS/Windows for more information on programming the NI GPIB port.

## LIST OF MODEL 2090 GPIB COMMANDS

---

### 1050/51/53 Command Set Supported by 2090:

UP	Move Tower Boom Up
DN	Move Tower Boom Down
ST	Stop Tower Boom Motion
CP	Prepares Controller to respond to future reads with the Current Position †
UL	Prepares Controller to respond to future reads with the Upper Limit †
LL	Prepares Controller to respond to future reads with the Lower Limit †
PV	Change Boom Polarization to Vertical
PH	Change Boom Polarization to Horizontal
LD	Load either CP, UL, or LL into the controller
P?	Prepares Controller to respond to future reads with the current polarization †

### 1060 Command Set Supported by 2090:

CW	Move Turntable Clockwise
CC	Move Turntable Counterclockwise
ST	Stop Turntable Motion
CP	Prepares Controller to respond to future reads with the Current Position †
WL	Prepares Controller to respond to future reads with the Clockwise Limit †
CL	Prepares Controller to respond to future reads with the Counterclockwise limit †
LD	Load either CP, WL, or CL into the controller

† These commands are obsolete as defined. On the models 1050 and 1060, these commands changed the front panel to display the specified value and prepared the controller to respond to all future reads with that value. This is not compatible with the IEEE 488.2 standard; the program **must** send the command before each read. For programs which will not be used with a model 1050 or 1060, use the corresponding query commands (command followed by a question mark (?)) listed below.

### 1090 Command Set Supported by 2090:

*Note: The 1050 and 1060 command set may be used as previously noted; the additional functionality of these commands is noted below:*

CC	Move Turntable counterclockwise
CL	Set counterclockwise limit
CL?	Query counterclockwise limit
CP	Set the current position
CP?	Query the current position
CW	Move Turntable clockwise
CY	Set number of scan cycles
CY?	Query number of scan cycles
DN	Move Tower boom down
LH	Set the horizontal lower limit
LH?	Query the horizontal lower limit

LL	Set lower limits (both horizontal and vertical)
LL?	Query lower limits
LV	Set vertical lower limit
LV?	Query the vertical lower limit
PH	Change boom polarization to horizontal
PV	Change boom polarization to vertical
P?	Query state of polarization
RTL	Return to local
SC	Scan
SK	Seek previously specified target
ST	Stop motion
TG	Set target for seek
TG?	Query target for seek
UL	Set upper limits (both horizontal and vertical)
UL?	Query upper limit
UP	Move tower boom up
WL	Set clockwise limit on turntables
WL?	Query clockwise limit on turntables

*NOTE: The 2090 does not support the majority of the 1090 Expanded Instruction Set. Those commands which relate to multiple devices are not supported. The Model 2090 controller behaves similar to multiple 1090's with only a single motor base device connected to each.*

**2090 Command Set:**

AIR Set flotation mode of an air flotation turntable  
 AUX Set auxiliary control(s) ON/OFF  
 AUX# Set an auxiliary control ON/OFF  
 AUX#? Query the ON/OFF state of an auxiliary control  
 CAL Set the encoder calibration for a device  
 CAL? Query the encoder calibration for a device  
 ERE Set the Device Dependent Error Enable Register  
 ERE? Query the Device Dependent Error Enable Register  
 ERR? Query the Device Dependent Error Register  
 N1 Set numeric mode 1 (1050/60/90 -- xxx)  
 N2 Set numeric mode 2 (2090 -- xxx.x)  
 OFF Set polarization offset for a standard tower  
 OFF? Query polarization offset for a standard tower  
 S# Select speed on two speed/variable speed device  
 S? Query speed selection on a two speed/variable speed device  
 SEP Set separation distance to EUT for bore sight tower  
 SEP? Query separation distance to EUT for bore sight tower  
 SK Seek specified target  
 SKN Seek specified target in negative direction  
 SKP Seek specified target in the positive direction  
 SKR Seek relative to the current position  
 SS# Set speed setting on a variable speed device  
 SS? Query speed setting on a variable speed device  
 TT Select turntable and type  
 TWR Select tower and type  
 TYP? Query device and type  
 UH Set horizontal upper limit  
 UH? Query horizontal upper limit  
 UV Set vertical upper limit  
 UV? Query vertical upper limit

**IEEE 488.2 Mandatory Instruction Set:**

\*CLS Clear Status Register  
 \*ESE Set Standard Event Status Enable Register  
 \*ESE? Query Standard Event Status Enable Register  
 \*ESR? Query Standard Event Status Register  
 \*IDN? Query Identity  
 \*OPC Arm Operation Complete Flag  
 \*OPC? Query Operation Complete  
 \*RST Reset  
 \*SRE Set Service Request Enable Register  
 \*SRE? Query Service Request Enable Register  
 \*STB? Query Status Byte Register  
 \*TST? Self Test  
 \*WAI Wait To continue

## ALPHABETICAL LIST OF MODEL 2090 GPIB COMMANDS

---

<b>CMD</b>	<b>Description</b>	<b>Compatibility</b>
AIR	Set flotation mode of an air flotation turntable	2090
AUX	Set auxiliary control(s) ON/OFF	2090 <sup>1</sup>
AUX#	Set an auxiliary control ON/OFF	2090 V3.00 <sup>1</sup>
AUX#?	Query the ON/OFF state of an auxiliary control	2090 V3.00 <sup>1</sup>
CAL	Set the encoder calibration for a device	2090 V2.30
CAL?	Query the encoder calibration for a device	2090 V2.30
CC	Move turntable counterclockwise	All
CL	Prepares controller to respond to a read with the counterclockwise limit	1050, 1060 <sup>2</sup>
CL	Set counterclockwise limit	1090, 2090
CL?	Query counterclockwise limit	1090, 2090
CP	Prepares controller to respond to a read with the current position	1050, 1060 <sup>2</sup>
CP	Set the current position	1090, 2090
CP?	Query the current position	1090, 2090
CW	Move turntable clockwise	All
CY	Set number of scan cycles	1090, 2090
CY?	Query number of scan cycles	1090, 2090
DIR?	Query the current motion direction	2090 V3.00
DN	Move tower boom down	All
ERE	Set the Device Dependent Error Enable Register	2090 V2.30
ERE?	Query the Device Dependent Error Enable Register	2090 V2.30
ERR?	Query the Device Dependent Error Register	2090 V2.30
LD	Load any of CL, CP, LL, UL, or WL into the controller	1050, 1060 <sup>3</sup>
LH	Set the horizontal lower limit	1090, 2090
LH?	Query the horizontal lower limit	1090, 2090
LL	Prepares controller to respond to a read with the lower limit	1050, 1060 <sup>2</sup>
LL	Set lower limits (both horizontal and vertical)	1090, 2090
LL?	Query lower limit	1090, 2090
LV	Set vertical lower limit	1090, 2090
LV?	Query the vertical lower limit	1090, 2090
N1	Set numeric mode 1 (1050/60/90 -- xxx)	2090
N2	Set numeric mode 2 (2090 -- xxx.x)	2090
OFF	Set polarization offset for a standard tower	2090 V2.2
OFF?	Query polarization offset for a standard tower	2090 V2.2
PH	Change boom polarization to horizontal	All
PV	Change boom polarization to vertical	All
P?	Query state of polarization	All
RTL	Return to local	1090, 2090
S#	Select speed on two speed/variable speed device	2090 V2.1

S?	Query speed selection on a two speed/variable speed device	2090 V2.1
SC	Initiate scan mode	1090, 2090
SC?	Query if device is in scan mode	2090 V3.00
SEP	Set separation distance to EUT for bore sight tower	2090
SEP?	Query separation distance to EUT for bore sight tower	2090
SK	Seek previously specified target	1090, 2090
SK	Seek specified target	2090
SKN	Seek specified target in negative direction	2090 V2.3
SKP	Seek specified target in the positive direction	2090 V2.3
SKR	Seek relative to the current position	2090 V2.3
SS#	Set speed setting on a variable speed device	2090 V2.25
SS#?	Query speed setting on a variable speed device	2090 V2.25
ST	Stop motion	All
TG	Set target for seek	1090, 2090
TG?	Query target for seek	1090, 2090
TT	Select turntable and type	2090
TWR	Select tower and type	2090
TYP?	Query device and type	2090
UH	Set horizontal upper limit	2090
UH?	Query horizontal upper limit	2090
UL	Prepares controller to respond to a read with the upper limit	1050, 1060 <sup>2</sup>
UL	Set upper limits (both horizontal and vertical)	1090, 2090
UL?	Query upper limit	1090, 2090
UP	Move tower boom up	All
UV	Set vertical upper limit	2090
UV?	Query vertical upper limit	2090
VS?	Query if a device supports variable speed functions	2090 V3.00
WL	Prepares controller to respond to a read with the clockwise limit	1050, 1060 <sup>2</sup>
WL	Set clockwise limit on turntables	1090, 2090
WL?	Query clockwise limit on turntables	1090, 2090
ZERO	Initiate a zero reference check on equipped devices.	2090 V3.00
ZERO?	Query if a device is equipped with an absolute reference.	2090 V3.00
*CLS	Clear Status Register	1090, 2090
*ESE	Set Standard Event Status Enable Register	1090, 2090
*ESE?	Query Standard Event Status Enable Register	1090, 2090
*ESR?	Query Standard Event Status Register	1090, 2090
*IDN?	Query Identity	1090, 2090
*OPC	Arm Operation Complete Flag	1090, 2090
*OPC?	Query Operation Complete	1090, 2090
*RST	Reset	1090, 2090
*SRE	Set Service Request Enable Register	1090, 2090
*SRE?	Query Service Request Enable Register	1090, 2090
*STB?	Query Status Byte Register	1090, 2090

\*TST? Self Test 1090, 2090  
\*WAI Wait To Continue 1090, 2090

- <sup>1</sup> These commands are not supported by the Model 2190 Virtual Device Controller since it does not have auxiliary control ports.
- <sup>2</sup> These commands are obsolete as defined. On the models 1050 and 1060, these commands changed the front panel to display the specified value and prepared the controller to respond to all future reads with that value. This is not compatible with the IEEE 488.2 standard; the program **must** send the command before each read. For programs which will not be used with a model 1050 or 1060, use the corresponding query commands (command followed by a question mark (?)).
- <sup>3</sup> This command is obsolete. For programs which will not be used with a model 1050 or 1060, use the corresponding set commands (leave the LD command off of the corresponding limit or position value).

### Detailed Description of MODEL 2090 GPIB Commands

The following notation will be used for each command:

---

COMMAND NAME	
<b>Compatibility:</b>	Backwards compatibility and revision history information
<b>Description:</b>	Description of the command function and any associated special information.
<b>Devices:</b>	List of devices types this command applies to. "Towers" refers to all linear positioning devices; "Turntables" refers to all rotational positioning devices
<b>Syntax:</b>	CMD <required parameter> [optional parameter] parameter list List of parameters and their descriptions (as required) with any associated special information.
<b>Response:</b>	response If applicable, description of expected response from queries, with any associated special information.
<b>Example:</b>	CALL ibwr (TowerUD%, "CMD parm") ' Sample Visual Basic GPIB ' calls and associated comments
<b>See Also:</b>	<i>List of other related commands.</i>

## Detailed Command List

---

### AIR

**Compatibility:** 2090  
**Description:** Activates or deactivates flotation on air flotation turntables. Simple on/off control.  
**Devices:** Turntables  
**Syntax:** AIR <ON/OFF>  
                   ON/OFF                   Air ON or OFF  
**Example:** CALL ibwrt (TableUD%, "AIR ON")       ' Turns AIR on  
               CALL ibwrt (TableUD%, "AIR OFF")     ' Turns AIR off

---

### AUX

**Compatibility:** 2090  
**Description:** Activates or deactivates one or more auxiliary devices.  
**Devices:** Auxiliary devices (command can be sent to Towers or Turntables)  
**Syntax:** AUX <Device #> [Device #] [Device #] [Device #] <ON/OFF>  
                   Device #                   List of one or more Auxiliary Control device numbers separated by white space. . Valid values are in the range of 1-4.  
                   ON/OFF                   Set the listed auxiliary ports ON or OFF.  
**Example:** CALL ibwrt (TowerUD%, "AUX 1 ON")     ' Turn auxiliary 1 on  
               CALL ibwrt (TableUD%, "AUX 3 4 OFF") ' Turn auxiliaries 3 and 4 off  
  
**See Also:**                   *AUX#, AUX#?*

---

### AUX#

**Compatibility:** 2090 (Firmware Rev. 3.00)  
**Description:** Activates or deactivates specified auxiliary device. This command is slightly different from the original AUX command (above) in that there is no white space between AUX and the device number, and that only one device can be set at a time.  
**Devices:** Auxiliary devices (command can be sent to Towers or Turntables)  
**Syntax:** AUX# <ON/OFF>  
                   #                   Desired Auxiliary Control device number. Valid values are in the range of 1-4.  
                   ON/OFF                   Set the specified auxiliary port ON or OFF.  
**Example:** CALL ibwrt (TowerUD%, "AUX1 ON")     ' Turn auxiliary 1 on  
               CALL ibwrt (TableUD%, "AUX3 OFF")   ' Turn auxiliary 3 off  
  
**See Also:**                   AUX, AUX#?



**AUX#?**

**Compatibility:** 2090 (Firmware Rev. 3.00)  
**Description:** Queries the state of the specified auxiliary device control.  
**Devices:** Auxiliary devices (command can be sent to Towers or Turntables)  
**Syntax:** AUX#?  
           #                  Desired Auxiliary Control device number. Valid values are in the range of 1-4.  
**Response:** <number>          Returns 1 if ON, 0 if OFF.  
**Example:** CALL ibwrt (TowerUD%, "AUX1?")      ' Query state of auxiliary 1  
           CALL ibrd (TowerUD%, rdbuf\$)          ' Read response  
**See Also:**            AUX, AUX#

---

**CAL**

**Compatibility:** 2090 (Firmware Rev 2.30)  
**Description:** Changes the encoder calibration setting of the device. Value must be between 1 and 9999. This number is the number of encoder counts per meter or revolution. The default value for an ETS-Lindgren tower is 2000 counts per meter, and for an ETS-Lindgren turntable is 3600 counts per revolution. Refer to the documentation on the  $\square$  encoder calibration parameter for typical values for various ETS-Lindgren products. This command is intended to allow automated configuration of the 2090 and should not be used by most programs.  
**Devices:** Towers, Turntables  
**Syntax:** CAL <XXXX>  
           <XXXX>          Integer value for the encoder calibration to be set. Leading zeros are optional.  
**Example:** CALL ibwrt (TowerUD%, "CAL 2000")      ' Set tower encoder to  
   ' 2000 counts/meter  
**See Also:**            CAL?

---

**CAL?**

**Compatibility:** 2090 (Firmware Rev 2.30)  
**Description:** Query the encoder calibration setting of the device. Value returned is between 1 and 9999. This number is the number of encoder counts per meter or revolution.  
**Devices:** Towers, Turntables  
**Syntax:** CAL?  
**Response:** <number>          Value between 1 and 9999.  
**Example:** CALL ibwrt (TowerUD%, "CAL?")      ' Query tower encoder cal.  
           CALL ibrd (TowerUD%, rdbuf\$)          ' Read response  
           CALL ibwrt (TableUD%, "CAL?")          ' Query turntable encoder cal.  
           CALL ibrd (TableUD%, rdbuf\$)          ' Read response  
**See Also:**            CAL

---

**CC**

<b>Compatibility:</b>	All	
<b>Description:</b>	Instructs the turntable to move in the counterclockwise direction. This movement is limited by the counterclockwise limit.	
<b>Devices:</b>	Turntables	
<b>Syntax:</b>	CC	
<b>Example:</b>	CALL ibwrt (TableUD%, "CC")	' Direct turntable to rotate ' counterclockwise.
<b>See Also:</b>	CW	

---

**CL**

<b>Compatibility:</b>	1050, 1060	
<b>Description:</b>	Queries the turntable's counterclockwise limit. The value returned is either in N1 (XXX) or N2 (XXX.X) format depending upon the current numeric mode. Negative values are preceded by a "-" minus sign. This command is obsolete. On the models 1050 and 1060, this command changed the front panel to display the counterclockwise limit and prepared the controller to respond to all future reads with that limit. This is not compatible with the IEEE 488.2 standard; the program <b>must</b> send the CL command before each read. For programs which will not be used with a model 1050 or 1060, use the CL? Command.	
<b>Devices:</b>	Turntables	
<b>Syntax:</b>	CL	
<b>Response:</b>	[-]XXX[X]	Value of the counterclockwise limit setting in degrees.
<b>Example:</b>	CALL ibwrt (TableUD%, "CL")	' Query turntable counter- ' clockwise limit
	CALL ibrd (TableUD%, rdbuf\$)	' Read response
<b>See Also:</b>	CL 1090/2090, CL?	

---

**CL**

<b>Compatibility:</b>	1090, 2090	
<b>Description:</b>	Changes the counterclockwise limit of the device. The specified value must be less than the clockwise limit and between -999.9 and 999.9. Note that, unlike editing from the front panel, the 2090 allows setting the limit above the current position from the GPIB.	
<b>Devices:</b>	Turntables	
<b>Syntax:</b>	CL [+/-] XXX[X]	Optional for positive values Necessary for negative values
	+	Optional for positive values
	-	Necessary for negative values
	XXX[X]	Decimal value for the counterclockwise limit to be set in degrees. In N1 mode .X is ignored In N2 mode .X is optional. Leading zeros are optional.
<b>Example:</b>	CALL ibwrt (TableUD%, "CL -100")	' Change CCW limit of the ' turntable to -100 degrees.
	CALL ibwrt (TableUD%, "CL 235.7")	' Change CCW limit of the ' turntable to 235.7 degrees.
<b>See Also:</b>	CL 1050/1060, CL?	

---

**CL?**

**Compatibility:** 1090, 2090  
**Description:** Queries the turntable's counterclockwise limit. The value returned is either in N1 (XXX) or N2 (XXX.X) format depending upon the current numeric mode. Negative values are preceded by a "-" minus sign.  
**Devices:** Turntables  
**Syntax:** CL?  
**Response:** [-]XXX[X] Value of the counterclockwise limit setting in degrees.  
**Example:** CALL ibwrt (TableUD%, "CL?") ' Query turntable counter  
' clockwise limit  
CALL ibrd (TableUD%, rdbuf\$) ' Read response  
**See Also:** CL 1050/1060, CL 1090/2090

---

**CP**

**Compatibility:** 1050, 1060  
**Description:** Query the current position. The value returned is either in N1 (XXX) or N2 (XXX.X) format depending upon the current numeric mode. Negative values are preceded by a "-" minus sign. Towers return current position in centimeters, turntables return it in degrees. *This command is obsolete.* On the models 1050 and 1060, this command changed the front panel to display the current position and prepared the controller to respond to all future reads with the current position. This is not compatible with the IEEE 488.2 standard; the program **must** send the CP command before each read. For programs which will not be used with a model 1050 or 1060, use the CP? command.  
**Devices:** Towers, Turntables  
**Syntax:** CP  
**Response:** [-]XXX[X] Value of the current position in centimeters for towers or degrees for turntables.  
**Example:** CALL ibwrt (TowerUD%, "CP") ' Query tower current position  
CALL ibrd (TowerUD%, rdbuf\$) ' Read response  
CALL ibwrt (TableUD%, "CP") ' Query turntable current posn  
CALL ibrd (TableUD%, rdbuf\$) ' Read response  
**See Also:** CP 1090/2090, CP?

**CP**

**Compatibility:** 1090, 2090  
**Description:** Changes the current position of the device. Value must be between -999.9 and 999.9. Note that, unlike editing from the front panel, the 2090 allows setting the current position outside the limit settings from the GPIB.  
**Devices:** Towers, Turntables  
**Syntax:** CP [+/-] XXX[X]  
 + Optional for positive values  
 - Necessary for negative values  
 XXX[X] Decimal value for the current position to be set in centimeters for towers and degrees for turntables.  
 In N1 mode .X is ignored  
 In N2 mode .X is optional.  
 Leading zeros are optional.  
**Example:** CALL ibwrt (TowerUD%, "CP 100.7") ' Change tower current  
 ' position to 100.7 cm.  
**See Also:** CP 1050/1060, CP?

**CP?**

**Compatibility:** 1090, 2090  
**Description:** Query the current position. The value returned is either in N1 (XXX) or N2 (XXX.X) format depending upon the current numeric mode. Negative values are preceded by a "-" minus sign. Towers return current position in centimeters, turntables return it in degrees.  
**Devices:** Towers, Turntables  
**Syntax:** CP?  
**Response:** [-]XXX[X] Value of the current position in centimeters for towers or degrees for turntables.  
**Example:** CALL ibwrt (TowerUD%, "CP?") ' Query tower current position  
 CALL ibrd (TowerUD%, rdbuf\$) ' Read response  
 CALL ibwrt (TableUD%, "CP?") ' Query turntable current posn  
 CALL ibrd (TableUD%, rdbuf\$) ' Read response  
**See Also:** CP 1050/1060, CP 1090/2090

**CW**

**Compatibility:** All  
**Description:** Instructs the turntable to move in the clockwise direction. This movement is limited by the clockwise limit.  
**Devices:** Turntables  
**Syntax:** CW  
**Example:** CALL ibwrt (TableUD%, "CW") ' Instruct turntable to rotate  
 ' clockwise.  
**See Also:** *CC, ST*



---

**DIR?**

<b>Compatibility:</b>	2090 (Firmware Rev 3.00)	
<b>Description:</b>	Queries the motion direction for the device and provides an enhancement over the functionality provided by the *OPC and *OPC? commands. Unlike *OPC or *OPC?, which indicate the completion of a motion command, the DIR? Command returns the current motion of the device, and thus may take on several values during the course of a single motion command. The response of the DIR? command corresponds to the state of the motion indicators on the front panel of the 2090. Thus, if a device is commanded to change direction, the DIR? command will switch between indicating the current direction, a stopped condition, then the new direction, and finally stopped at the end of the target motion. For the same command, *OPC? will respond with a zero until the stop at the end of the target motion. Similarly, when in SCAN mode, *OPC? will always respond with zero until another motion command or stop is issued and completed, while DIR? will change each time the motion changes.	
<b>Devices:</b>	Towers, Turntables	
<b>Syntax:</b>	DIR?	
<b>Response:</b>	<direction>	Value indicating the current motion of the queried device.
	+1	Device is moving up/clockwise.
	0	Device is stopped.
	-1	Device is moving down/counterclockwise.
<b>Example:</b>	CALL ibwrt (TowerUD%, "DIR?")	' Query tower motion direction
	CALL ibrd (TowerUD%, rdbuf\$)	' Read response
	CALL ibwrt (TableUD%, "DIR?")	' Query turntable motion dir.
	CALL ibrd (TableUD%, rdbuf\$)	' Read response
<b>See Also:</b>	*OPC, *OPC?	

---

**DN**

<b>Compatibility:</b>	All	
<b>Description:</b>	Instructs the tower boom to move in the Down direction. This movement is limited by the lower limit.	
<b>Devices:</b>	Towers	
<b>Syntax:</b>	DN	
<b>Example:</b>	CALL ibwrt (TowerUD%, "DN")	' Instruct the boom of the tower to move down
<b>See Also:</b>	ST, UP	

---

### ERE

**Compatibility:** 2090 (Firmware Rev 2.3)  
**Description:** Set Device Dependent Error Enable Register. Causes changes in the contents of the Device Dependent Error Enable Register. Requires a decimal argument in binary form to set the register. The bits of the argument correspond to the bits of the Device Dependent Error Register. Setting a bit in this register allows the corresponding bit in the Device Dependent Error Register to cause the DDE bit in the Status Byte Register to be set.

**Devices:** Towers, Turntables  
**Syntax:** ERE XXXXX  
          XXXXX           Integer value representing a sixteen bit binary number 0-65535

**Example:** CALL ibwrt (TowerUD%, "ERE 64")           ' Allow a polarization violation  
  ' to set the DDE bit of STB

**See Also:** ERE?, ERR?, \*STB?

---

### ERE?

**Compatibility:** 2090 (Firmware Rev 2.3)  
**Description:** Query Device Dependent Error Enable Register. Prepares the controller to respond with the contents of the Device Dependent Error Enable Register when queried. Value returned is an integer number in the range of 0 to 65535. This value, when expressed in binary form, represents bit values of the Device Dependent Error Enable Register.

**Devices:** Towers, Turntables  
**Syntax:** ERE?  
**Response:**     <ERE bits>           Integer value representing a sixteen bit binary number 0-65535.

**Example:** CALL ibwrt (TableUD%, "ERE?")           ' Query ERE register  
  ' Read response  
CALL ibrd (TableUD%, rdbuf\$)

**See Also:** ERE, ERR?, \*STB?

**ERR?**

**Compatibility:** 2090 (Firmware Rev 2.3)  
**Description:** Query Device Dependent Error Register. Prepares the controller to respond to the contents of the Device Dependent Error Register when queried. The value returned is a decimal in the range of 0 to 65535. This value, when expressed in binary form, represents the sixteen bit value of the Device Dependent Error Register. *NOTE: Upon reading this register, its contents will be cleared.* As long as bits are set in this register, any commands related to device motion or position settings will generate and execution error (see \*ESR?). The bit pattern of this register corresponds to the front panel errors reported by the 2090 and is defined below:

**Devices:** Towers, Turntables

**Syntax:** ERR?

**Response:** <error bits> Integer value representing a sixteen bit binary number 0-65535. The bits are defined as follows:

0	- Undefined	
1	- Parameters Lost	Set at startup if the 2090 detects that previous settings have been lost
2	- Motor Not Moving	Indicates a device stuck condition. The controller automatically generates a STOP condition to protect the motor.
3	- Motor Not Stopping	Indicates that the device failed to stop moving when commanded.
4	- Moving Wrong Direction	Indicates that the device moved in the opposite direction of that commanded.
5	- Hard Limit Hit	Indicates that the device is unable to move because it is at a hardware limit.
6	- Polarization Limit Violation	Indicates that the tower was told to change polarization while it was outside the position limits specified for the new polarization.
7	- Communication Lost	Indicates that the controller is unable to communicate with the device over the fiber optic link.
8	- Flotation Violation	Indicates that the air flotation turntable was told to turn flotation off while it was moving.
9	- Encoder Failure	Indicates that the 2090 has detected device encoder behavior consistent with a fault in the encoder, its wiring, or connections.
10	- Undefined	
11	- Undefined	
12	- Undefined	
13	- Undefined	
14	- Undefined	
15	- Undefined	

**Example:** CALL ibwrt (TowerUD%, "ERR?") ' Query error register  
 CALL ibrd (TowerUD%, rdbuf\$) ' Read response

**See Also:** ERE, ERE?, \*STB?



**LD**

**Compatibility:** 1050, 1060  
**Description:** Loads a position/limit value. Used for the setting of the CP, CL, LL, UL, and WL. *This command is obsolete.* For programs which will not be used with a model 1050 or 1060, use the 2090 CP, CL, LL, UL, and WL commands.  
**Devices:** Towers, Turntables  
**Syntax:** LD [+/-] XXX[.X][CM/DG] <value>

+	Optional for positive values
-	Necessary for negative values
XXX[.X]	Decimal value for the value to be set in centimeters for towers and degrees for turntables. In N1 mode .X is ignored In N2 mode .X is optional. Leading zeros are optional.
CM	Optional—has no effect
DG	Optional—has no effect
<value>	CP, CL, LL, UL, or WL

**Example:**

```
CALL ibwrt (TowerUD%, "LD 100 UL") ' Set tower upper limit
                                     ' to 100 cm
CALL ibwrt (TableUD%, "LD 100.7 CP") ' Set turntable current
                                     ' position to 100.7 degrees
```

**See Also:** CP, CL, LL, UL, WL

**LH**

**Compatibility:** 1090, 2090  
**Description:** Changes the lower limit of the device for horizontal polarity. The specified value must be less than the upper limit for the horizontal polarization and between -999.9 and 999.9. Note that, unlike editing from the front panel, the 2090 allows setting the limit above the current position from the GPIB.  
**Devices:** Towers  
**Syntax:** LH [+/-] XXX[.X]

+	Optional for positive values
-	Necessary for negative values
XXX[.X]	Decimal value for the lower limit to be set in centimeters. In N1 mode .X is ignored In N2 mode .X is optional. Leading zeros are optional.

**Example:**

```
CALL ibwrt (TowerUD%, "LH 235.8") ' Set horizontal polarity lower
                                     ' limit to 235.8 cm
```

**See Also:** LH?

---

**LH?**

<b>Compatibility:</b>	1090, 2090	
<b>Description:</b>	Queries the lower limit of the device for horizontal polarity. The value returned is either in N1 (XXX) or N2 (XXX.X) format depending upon the current numeric mode. Negative values are preceded by a "-" minus sign.	
<b>Devices:</b>	Towers	
<b>Syntax:</b>	LH?	
<b>Response:</b>	[-]XXX[.X]	Value of the lower limit for horizontal polarization in centimeters.
<b>Example:</b>	CALL ibwrt (TowerUD%, "LH?")	' Query horizontal lower limit
	CALL ibrd (TowerUD%, rdbuf\$)	' Read response
<b>See Also:</b>	LH	

---

**LL**

<b>Compatibility:</b>	1050, 1060	
<b>Description:</b>	Queries the tower's lower limit. LL returns the limit associated with the current polarization mode. The value returned is either in N1 (XXX) or N2 (XXX.X) format depending upon the current numeric mode. Negative values are preceded by a "-" minus sign. <i>This command is obsolete.</i> On the models 1050 and 1060, this command changed the front panel to display the lower limit and prepared the controller to respond to all future reads with that limit. This is not compatible with the IEEE 488.2 standard; the program <b>must</b> send the LL command before each read. For programs which will not be used with a model 1050 or 1060, use the LL? command.	
<b>Devices:</b>	Towers	
<b>Syntax:</b>	LL	
<b>Response:</b>	[-]XXX[.X]	Value of the lower limit for the current polarization in centimeters.
<b>Example:</b>	CALL ibwrt (TowerUD%, "LL")	' Query tower lower limit for
		' current polarization
	CALL ibrd (TowerUD%, rdbuf\$)	' Read response
<b>See Also:</b>	LL 1090/2090, LL?	

**LL**

**Compatibility:** 1090, 2090

**Description:** Changes the lower limit of the device. The specified value must be less than the upper limit and between -999.9 and 999.9. This command effects both the horizontal and vertical limits, simultaneously. Note that, unlike editing from the front panel, the 2090 allows setting the limit above the current position from the GPIB.

**Devices:** Towers

**Syntax:** LL [+/-] XXX[.X]

+                   Optional for positive values

-                   Necessary for negative values

XXX[.X]           Decimal value for the lower limit to be set in centimeters.

In N1 mode .X is ignored

In N2 mode .X is optional.

Leading zeros are optional.

**Example:** CALL ibwrt (TowerUD%, "LL 208.8")     ' Change both the horizontal  
' and vertical polarization  
' lower limits of the tower to  
' 208.8 cm.

**See Also:** LL 1050/1060, LL?

**LL?**

**Compatibility:** 1090, 2090

**Description:** Query the lower limit of the device. LL? returns the limit associated with the current polarization mode. The value returned is either in N1 (XXX) or N2 (XXX.X) format depending upon the current numeric mode. Negative values are preceded by a "-" minus sign.

**Devices:** Towers

**Syntax:** LL?

**Response:** [-]XXX[.X]           Value of the lower limit for the current polarization in centimeters.

**Example:** CALL ibwrt (TowerUD%, "LL?")     ' Query tower lower limit for  
' current polarization

CALL ibrd (TowerUD%, rdbuf\$)           ' Read response

**See Also:** LL 1050/1060, LL 1090/2090

---

**LV**

<b>Compatibility:</b>	1090, 2090	
<b>Description:</b>	Changes the lower limit of the device for vertical polarity. The specified value must be less than the upper limit for the vertical polarization and between -999.9 and 999.9. Note that, unlike editing from the front panel, the 2090 allows setting the limit above the current position from the GPIB.	
<b>Devices:</b>	Towers	
<b>Syntax:</b>	LV [+/-] XXX[.X]	
	+	Optional for positive values
	-	Necessary for negative values
	XXX[.X]	Decimal value for the lower limit to be set in centimeters.
		In N1 mode .X is ignored
		In N2 mode .X is optional.
		Leading zeros are optional.
<b>Example:</b>	CALL ibwrt (TowerUD%, "LV 95")	' Set vertical polarity lower ' limit to 95 cm
<b>See Also:</b>	LV?	

---

**LV?**

<b>Compatibility:</b>	1090, 2090	
<b>Description:</b>	Queries the lower limit of the device for vertical polarity. The value returned is either in N1 (XXX) or N2 (XXX.X) format depending upon the current numeric mode. Negative values are preceded by a "-" minus sign.	
<b>Devices:</b>	Towers	
<b>Syntax:</b>	LV?	
<b>Response:</b>	[-]XXX[.X]	Value of the lower limit for the vertical polarization in centimeters.
<b>Example:</b>	CALL ibwrt (TowerUD%, "LV?")	' Query vertical lower limit
	CALL ibrd (TowerUD%, rdbuf\$)	' Read response
<b>See Also:</b>	LV	

---

**N1**

<b>Compatibility:</b>	2090	
<b>Description:</b>	Places the controller in the backward compatible numeric mode 1. This mode provides a GPIB readout accuracy of 3 (XXX) digits. Fractional numbers are rounded to the nearest integer prior to reporting them over the GPIB. Fractional numbers received by the 2090 are truncated. This is the default mode of operation for the 2090. This setting has no effect on the 2090's internal or display accuracy. This command is global, changing the numeric mode of both primary devices.	
<b>Devices:</b>	Towers, Turntables	
<b>Syntax:</b>	N1	
<b>Example:</b>	CALL ibwrt (TowerUD%, "N1")	' changes numeric mode of ' the tower to 1050/1060/1090 ' compatibility.
<b>See Also:</b>	N2	

**N2**

**Compatibility:** 2090  
**Description:** Places the controller in the 2090 compatible numeric mode two. This mode provides a GPIB readout accuracy of 4 (XXX.X) digits. This setting has no effect on the 2090's internal or display accuracy. This command is global, changing the numeric mode of both primary devices.  
**Devices:** Towers, Turntables  
**Syntax:** N2  
**Example:** CALL ibwrt (TowerUD%, "N2") ' changes numeric mode of  
' the tower to 4 digit readout  
**See Also:** N1

---

**OFF**

**Compatibility:** 2090 (Firmware Rev 2.2)  
**Description:** Sets the polarization offset of non-bore sight towers. (ETS-Lindgren bore sight towers have centerline rotation and do not require polarization offset corrections.) The specified offset value is added to the current position when switching from vertical to horizontal polarization and subtracted when switching from horizontal to vertical polarization.  
**Devices:** Towers  
**Syntax:** OFF [+/-] XX[.X]  
+ Optional for positive values  
- Necessary for negative values  
XX[.X] Decimal value between 50.0 and -50.0 for the offset to be set in centimeters.  
In N1 mode .X is ignored  
In N2 mode .X is optional.  
Leading zeros are optional.  
**Example:** CALL ibwrt (TowerUD%, "OFF 25.0") ' Set polarization offset to 25 cm  
**See Also:** OFF?

---

**OFF?**

**Compatibility:** 2090 (Firmware Rev 2.2)  
**Description:** Queries the polarization offset for standard (non-bore sight) towers. The value returned is either in N1 (XXX) or N2 (XXX.X) format depending upon the current numeric mode. Negative values are preceded by a "-" minus sign.  
**Devices:** Towers  
**Syntax:** OFF?  
**Response:** [-]XX[.X] Value of the polarization offset in centimeters.  
**Example:** CALL ibwrt (TowerUD%, "OFF?") ' Query polarization offset  
CALL ibrd (TowerUD%, rdbuf\$) ' Read response  
**See Also:** OFF

---

**PH**

**Compatibility:** All  
**Description:** Instructs a tower to change its boom polarization to horizontal.  
**Devices:** Towers  
**Syntax:** PH  
**Example:** CALL ibwrt (TowerUD%, "PH") ' Change boom polarization  
' to horizontal

**See Also:** P?, PV

---

**PV**

**Compatibility:** All  
**Description:** Instructs a tower to change its boom polarization to vertical.  
**Devices:** Towers  
**Syntax:** PV  
**Example:** CALL ibwrt (TowerUD%, "PV") ' Change boom polarization  
' to vertical

**See Also:** P?, PH

---

**P?**

**Compatibility:** All  
**Description:** Queries the polarization of the tower boom. A single digit value of "1" is returned if in the horizontal position. Otherwise a value of "0" is returned for vertical polarization. On the models 1050 and 1060, this command prepared the controller to respond to all future reads with the polarization. This is not compatible with the IEEE 488.2 standard; the program **must** send the P? command before each read.

**Devices:** Towers  
**Syntax:** P?  
**Response:** <polarization> Value indicating the polarization setting of the queried device.  
1 Horizontal  
0 Vertical

**Example:** CALL ibwrt (TowerUD%, "P?") ' Query twr boom polarization  
CALL ibrd (TowerUD%, rdbuf\$) ' Read response

**See Also:** PH, PV

---

**RTL**

**Compatibility:** 1090, 2090  
**Description:** Causes the device to return to local mode.  
**Devices:** Towers, Turntables  
**Syntax:** RTL  
**Example:** CALL ibwrt (TowerUD%, "RTL") ' Return tower controller to  
' local control

---

**S#**

**Compatibility:** 2090 (Firmware Rev 2.1)  
**Description:** Changes the speed selection of a two speed or variable speed device.

**Devices:** Towers, Turntables  
**Syntax:** Sn  
# For a two speed device: 1 = high, 2 = low  
For variable speed devices: 1-8 = preset speed selection. (Firmware versions prior to V3.00 only support 1-4 preset speeds.)

**Example:** CALL ibwrt (TableUD%, "S1") ' Change to high speed/preset 1

**See Also:** S?, SS#, SS#?

---

**S?**

**Compatibility:** 2090 (Firmware Rev 2.1)  
**Description:** Queries the speed selection of a two speed or variable speed device. For a two speed device, a single digit value of "1" is returned if in high speed mode. Otherwise a value of "2" is returned for low speed mode. For a variable speed device, returns a single digit value of 1-8 to report the currently selected speed preset.

**Devices:** Towers, Turntables  
**Syntax:** S?  
**Response:** <speed select> Value between 1 and 8 indicating the currently selected speed setting.

**Example:** CALL ibwrt (TableUD%, "S?") ' Query turntable speed  
CALL ibrd (TableUD%, rdbuf\$) ' Read response

**See Also:** S#, SS#, SS#?

---

**SC**

**Compatibility:** 1090, 2090  
**Description:** Instructs the device to begin scanning between preset lower and upper limits. The number of scans performed is determined by the value of cycles (CY) parameter which must be set prior to issuing the scan command.

**Devices:** Towers, Turntables  
**Syntax:** SC  
**Example:** CALL ibwrt (TowerUD%, "SC") ' Put tower in scan mode  
CALL ibwrt (TableUD%, "SC") ' Put turntable in scan mode

**See Also:** CY, CY?, SC?

---

**SC?**

**Compatibility:** 2090 (Firmware Rev. 3.00)  
**Description:** Queries the 2090 to determine if scan mode is active.  
**Devices:** Towers, Turntables  
**Syntax:** SC?  
**Response:**           <active>           Value indicating if scan mode is active for the queried device.  
                           1           Device is scanning  
                           0           Device is not in scan mode

**Example:**       CALL ibwrt (TowerUD%, "SC?")       ' Ask tower if it is scanning  
                   CALL ibrd (TowerUD%, rdbuf\$)       ' Read response

                  CALL ibwrt (TableUD%, "SC?")       ' Ask turntable if it is scanning  
                   CALL ibrd (TableUD%, rdbuf\$)       ' Read response

**See Also:**       SC

---

**SEP**

**Compatibility:** 2090  
**Description:** Changes the separation distance between the mast and the EUT. This value may be 3, 10, or 30 meters. This value is used in the calculation of the adjusted height when in bore sight mode.  
**Devices:** Towers—Bore Sight only  
**Syntax:** SEP XX  
                           XX           3, 10, or 30  
   Invalid values are ignored  
   Leading zeros are optional.

**Example:**       CALL ibwrt (TowerUD%, "SEP 03")       ' Change separation distance  
   ' to 3 meters

**See Also:**       SEP?

---

**SEP?**

**Compatibility:** 2090  
**Description:** Query the separation distance between the mast and the EUT. Value returned is in the form of "XXX". Values returned are 003, 010, and 030 meters.  
**Devices:** Towers—Bore Sight only  
**Syntax:** SEP?  
**Response:**       <distance>       Value of the bore sight separation distance. Valid return values are as follows:  
                           003       3 meters  
                           010       10 meters  
                           030       30 meters

**Example:**       CALL ibwrt (TowerUD%, "SEP?")       ' Query separation distance  
                   CALL ibrd (TowerUD%, rdbuf\$)       ' Read response

**See Also:**       SEP

---



**SK**

**Compatibility:** 1090, 2090  
**Description:** Instructs the device to begin seeking for a preset target value. The target (TG) value must be set prior to issuing the SK command. For a continuous rotation turntable or tuner, the device will seek the target value by the shortest possible path. Thus, a seek from 359.9 to 0.0 will rotate clockwise, not counterclockwise. See the SKN, SKP, and SKR commands for other ways to control the seek direction.  
**Devices:** Towers, Turntables  
**Syntax:** SK  
**Example:** CALL ibwrt (TowerUD%, "SK") ' Instruct tower boom to seek  
' preset target value  
CALL ibwrt (TableUD%, "SK") ' Instruct turntable to seek  
' preset target value  
**See Also:** SK 2090, SKN, SKP, SKR, TG, TG?

---

**SK**

**Compatibility:** 2090  
**Description:** Instructs the device to begin seeking the specified target value. The target must be located between the current upper/clockwise and lower/counterclockwise limits. This command is the equivalent of issuing a target (TG) command followed by a seek preset target (SK) command. For a continuous rotation turntable or tuner, the device will seek the target value by the shortest possible path. Thus, a seek from 359.9 to 0.0 will rotate clockwise, not counterclockwise. See the SKN, SKP, and SKR commands for other ways to control the seek direction.  
**Devices:** Towers, Turntables  
**Syntax:** SK [+/-] XXX[.X]  
+ Optional for positive values  
- Necessary for negative values  
XXX[.X] Decimal value for the seek target in centimeters for towers and degrees for turntables.  
In N1 mode .X is ignored  
In N2 mode .X is optional.  
Leading zeros are optional.  
**Example:** CALL ibwrt (TowerUD%, "SK 100.0") ' Instruct tower boom to seek  
' 100.0 cm  
CALL ibwrt (TableUD%, "SK 260") ' Instruct turntable to seek  
' 260 degrees  
**See Also:** SK 1090/2090, SKN, SKP, SKR, TG, TG?

---

**SKN**

<b>Compatibility:</b>	2090 (Firmware Rev 2.3)	
<b>Description:</b>	Instructs the device to begin seeking the specified target value in the negative (down/counterclockwise) direction only. If the target is up/clockwise from the current position, no motion occurs. The target must be located between the current upper/clockwise and lower/counterclockwise limits. This command is provided primarily to support continuous rotation turntables and reverberation paddles. It allows forcing the seek of a position from a particular direction. Thus, a SKN from 180.0 to 181.0 will rotate counterclockwise to reach the target value.	
<b>Devices:</b>	Towers, Turntables	
<b>Syntax:</b>	SKN [+/-] XXX[.X]	Optional for positive values Necessary for negative values
	+	Optional for positive values
	-	Necessary for negative values
	XXX[.X]	Decimal value for the seek target in centimeters for towers and degrees for turntables. In N1 mode .X is ignored In N2 mode .X is optional. Leading zeros are optional.
<b>Example:</b>	CALL ibwrt (TowerUD%, "SKN 100.0")	' Instruct tower boom to seek ' 100.0 cm if CP > 100.0
	CALL ibwrt (TableUD%, "SKN 260")	' Instruct turntable to seek ' 260 degrees if CP > 260 or ' in continuous rotation mode
<b>See Also:</b>	SK 2090, SKP, SKR	

---

**SKP**

<b>Compatibility:</b>	2090 (Firmware Rev 2.3)	
<b>Description:</b>	Instructs the device to begin seeking the specified target value in the position (up/clockwise) direction only. If the target is down/ counterclockwise from the current position, no motion occurs. The target must be located between the current upper/clockwise and lower/counterclockwise limits. This command is provided primarily to support continuous rotation turntables and reverberation paddles. It allows forcing the seek of a position from a particular direction. Thus, a SKP from 181.0 to 180.0 will rotate clockwise to reach the target value.	
<b>Devices:</b>	Towers, Turntables	
<b>Syntax:</b>	SKP [+/-] XXX[.X]	Optional for positive values Necessary for negative values
	+	Optional for positive values
	-	Necessary for negative values
	XXX[.X]	Decimal value for the seek target in centimeters for towers and degrees for turntables. In N1 mode .X is ignored In N2 mode .X is optional. Leading zeros are optional.
<b>Example:</b>	CALL ibwrt (TowerUD%, "SKP 255.0")	' Instruct tower boom to seek ' 255.0 cm if CP < 255.0
	CALL ibwrt (TableUD%, "SKP 260")	' Instruct turntable to seek ' 260 degrees if CP < 260 or ' in continuous rotation mode

**See Also:** SK 2090, SKN, SKR

---

**SKR**

**Compatibility:** 2090 (Firmware Rev 2.3)  
**Description:** Instructs the device to begin seeking the specified target value relative to the current position. The specified value is added to the current position to obtain the target position. Thus, a positive value will cause up/clockwise motion and a negative value will cause down/counterclockwise motion. If the calculated target is not located between the current upper/clockwise and lower/counterclockwise limits, motion will continue in the target direction until a limit is hit.

**Devices:** Towers, Turntables  
**Syntax:** SKR [+/-] XXX[.X]  
 + Optional for positive values  
 - Necessary for negative values  
 XXX[.X] Decimal value for the distance to move from the current position. This value is in centimeters for towers and degrees for turntables.  
 In N1 mode .X is ignored  
 In N2 mode .X is optional.  
 Leading zeros are optional.

**Example:** CALL ibwrt (TowerUD%, "SKR 10.0") ' Instruct tower boom to move  
 ' up 10.0 cm from CP  
 CALL ibwrt (TableUD%, "SKR -25") ' Instruct turntable to move  
 ' CCW 25 degrees

**See Also:** SK 2090, SKP, SKN

---

**SS#**

**Compatibility:** 2090 (Firmware Rev 2.25, Updated in Rev 3.00)  
**Description:** Sets a preset speed setting for a variable speed device.

**Devices:** Towers, Turntables  
**Syntax:** SS# <speed>  
 # A value from 1-8 to select the preset speed register to set. (Firmware revisions prior to V3.00 only support 4 speed settings.) **Warning:** There can be no white space between the command and the register number. However, there **must** be white space between the register number and the speed value.  
 <speed> Value from 0-255 representing the desired speed setting for the specified speed selection. A value of 0 represents the minimum available speed of the device, while a value of 255 represents the maximum. The actual speed of the device is given approximately by the formula:  
 Actual Speed = <speed> (MaxSpeed - MinSpeed) / 255 + MinSpeed

**Example:** CALL ibwrt (TowerUD%, "SS2 127") ' Set speed 2 to half speed  
 CALL ibwrt (TableUD%, "SS5 63") ' Set speed 5 to quarter speed

**See Also:** S#, S?, SS#?

---

**SS#?**

<b>Compatibility:</b>	2090 (Firmware Rev 2.25, Updated in Rev 3.00)	
<b>Description:</b>	Queries a preset speed setting for a variable speed device.	
<b>Devices:</b>	Towers, Turntables	
<b>Syntax:</b>	#	A value from 1-8 to select the preset speed register to query. (Firmware revisions prior to V3.00 only support 4 speed settings.) <b>Warning:</b> There can be no white space between the command, the number, and the question mark (?).
<b>Response:</b>	<speed setting>	Value between 0 (minimum) and 255 (maximum) speed.
<b>Example:</b>	CALL ibwrt (TowerUD%, "SS7?")	' Query speed preset #7
	CALL ibrd (TowerUD%, rdbuf\$)	' Read response
	CALL ibwrt (TableUD%, "SS3?")	' Query speed preset #3
	CALL ibrd (TableUD%, rdbuf\$)	' Read response
<b>See Also:</b>	S#, S?, SS#	

---

**ST**

<b>Compatibility:</b>	All	
<b>Description:</b>	Causes device motion to stop.	
<b>Devices:</b>	Towers, Turntables	
<b>Syntax:</b>	ST	
<b>Example:</b>	CALL ibwrt (TowerUD%, "ST")	' Stops tower motion
	CALL ibwrt (TableUD%, "ST")	' Stops turntable motion
<b>See Also:</b>	CC, CW, DN, SC, SK, UP	

---

**TG**

<b>Compatibility:</b>	1090, 2090	
<b>Description:</b>	Changes the seek target position of the device. The target value must be located between the current upper/clockwise and lower/counter-clockwise limits.	
<b>Devices:</b>	Towers, Turntables	
<b>Syntax:</b>	TG [+/-] XXX[.X]	Optional for positive values Necessary for negative values Decimal value for the seek target in centimeters for towers and degrees for turntables. In N1 mode .X is ignored In N2 mode .X is optional. Leading zeros are optional.
<b>Example:</b>	CALL ibwrt (TowerUD%, "TG 100")	' Set tower target to 100 cm
	CALL ibwrt (TowerUD%, "SK")	' Seek preset target
	CALL ibwrt (TableUD%, "TG 260.5")	' Set turntable target to 260.5 ' degrees
	CALL ibwrt (TableUD%, "SK")	' Seek preset target
<b>See Also:</b>	SK, TG?	

**TG?**

**Compatibility:** 1090, 2090  
**Description:** *Query the seek target for the device. The value returned is either in N1 (XXX) or N2 (XXX.X) format depending upon the current numeric mode. Negative values are preceded by a "-" minus sign.*

**Devices:** Towers, Turntables  
**Syntax:** TG?  
**Response:** [-]XXX[.X] Value of the preset seek target in centimeters for towers or degrees for turntables.  
**Example:** CALL ibwrt (TableUD%, "TG?") ' Query turntable target  
 CALL ibrd (TableUD%, rdbuf\$) ' Read response  
**See Also:** SK, TG?

---

**TT**

**Compatibility:** 2090  
**Description:** Selects turntable mode of operation. Allows the selection of normal, two speed, and air flotation turntables. In the air flotation mode of operation, the UP/DOWN is controlled automatically by the 2090, assuring that the table is floating before a movement is made. This command is intended to allow automated configuration of the 2090 and should not be used by most programs.

**Devices:** Towers, Turntables  
**Syntax:** TT <NRM/AIR/TWO> <CONT/NONCONT>  
 NRM Normal turntable  
 AIR Air flotation turntable  
 TWO Two speed turntable  
 CONT Continuous rotation turntable  
 NONCONT Non-continuous rotation turntable  
**Example:** CALL ibwrt (TowerUD%, "TT NRM CONT") ' Change device from a tower to a normal, continuous turntable  
**See Also:** TWR, TYP?

---

**TWR**

**Compatibility:** 2090  
**Description:** Selects tower mode of operation. Allows the selection of both normal and bore sight towers. In the bore sight mode of operation, the separation distance is taken into account when reporting boom height. This command is intended to allow automated configuration of the 2090 and should not be used by most programs.

**Devices:** Towers, Turntables  
**Syntax:** TWR <NRM/BOR>  
 NRM Normal tower  
 BOR Bore sight tower  
**Example:** CALL ibwrt (TowerUD%, "TWR NRM") ' Change device to a normal tower  
**See Also:** TT, TYP?

---

---

**TYP?**

<b>Compatibility:</b>	2090	
<b>Description:</b>	Queries the current device type configuration.	
<b>Devices:</b>	Towers, Turntables	
<b>Syntax:</b>	TYP?	
<b>Response:</b>	<type string>	String indicating the device type and configuration. Possible values are:
	<i>TWR NRM</i>	Tower, Normal
	TWR BOR	Tower, Bore sight
	TT NRM CONT	Turntable, Normal, Continuous rotation
	TT NRM NONCONT	Turntable, Normal, Non-Continuous rotation
	TT AIR CONT	Turntable, Air Flotation, Continuous rotation
	TT AIR NONCONT	Turntable, Air Flotation, Non-Continuous
	TT TWO CONT	Turntable, Two Speed, Continuous rotation
	TT TWO NONCONT	Turntable, Two Speed, Non-Continuous
<b>Example:</b>	CALL ibwrt (TableUD%, "TYP?")	' Query device type
	CALL ibrd (TableUD%, rdbuf\$)	' Read response
<b>See Also:</b>	TT, TWR	

---

**UH**

<b>Compatibility:</b>	2090	
<b>Description:</b>	Changes the upper limit of the device for horizontal polarity. The specified value must be greater than the lower limit for horizontal polarization and between -999.9 and 999.9. <i>NOTE: Unlike editing from the front panel, the 2090 allows setting the limit above the current position from the GPIB.</i>	
<b>Devices:</b>	Towers	
<b>Syntax:</b>	UH [+/-] XXX[.X]	
	+	Optional for positive values
	-	Necessary for negative values
	XXX[.X]	Decimal value for the upper limit to be set in centimeters. In N1 mode .X is ignored In N2 mode .X is optional. Leading zeros are optional.
<b>Example:</b>	CALL ibwrt (TowerUD%, "UH 300.0")	' Set horizontal polarity upper ' limit to 300.0 cm
<b>See Also:</b>	UH?	

---

**UH?**

<b>Compatibility:</b>	2090	
<b>Description:</b>	Queries the upper limit of the device for horizontal polarity. The value returned is either in N1 (XXX) or N2 (XXX.X) format depending upon the current numeric mode. Negative values are preceded by a "-" minus sign.	
<b>Devices:</b>	Towers	
<b>Syntax:</b>	UH?	
<b>Response:</b>	[-]XXX[.X]	Value of the upper limit for horizontal polarization in centimeters.
<b>Example:</b>	CALL ibwrt (TowerUD%, "UH?")	' Query horizontal upper limit
	CALL ibrd (TowerUD%, rdbuf\$)	' Read response
<b>See Also:</b>	UH	

**UL**

**Compatibility:** 1050, 1060

**Description:** Queries the tower's upper limit. UL returns the limit associated with the current polarization mode. The value returned is either in N1 (XXX) or N2 (XXX.X) format depending upon the current numeric mode. Negative values are preceded by a "-" minus sign. *This command is obsolete.* On the models 1050 and 1060, this command changed the front panel to display the upper limit and prepared the controller to respond to all future reads with that limit. This is not compatible with the IEEE 488.2 standard; the program **must** send the UL command before each read. For programs which will not be used with a model 1050 or 1060, use the UL? command.

**Devices:** Towers

**Syntax:** UL

**Response:** [-]XXX[.X] Value of the upper limit for the current polarization in centimeters.

**Example:** CALL ibwrt (TowerUD%, "UL") ' Query tower upper limit for  
' current polarization  
CALL ibrd (TowerUD%, rdbuf\$) ' Read response

**See Also:** UL 1090/2090, UL?

**UL**

**Compatibility:** 1090, 2090

**Description:** Changes the upper limit of the device. The specified value must be greater than the lower limit and between -999.9 and 999.9. This command effects both the horizontal and vertical limits, simultaneously. *NOTE: Unlike editing from the front panel, the Model 2090 allows setting the limit above the current position from the GPIB.*

**Devices:** Towers

**Syntax:** UL [+/-] XXX[.X]

+ Optional for positive values

- Necessary for negative values

XXX[.X] Decimal value for the upper limit to be set in centimeters.  
In N1 mode .X is ignored  
In N2 mode .X is optional.  
Leading zeros are optional.

**Example:** CALL ibwrt (TowerUD%, "UL 400") ' Change both the horizontal  
' and vertical polarization  
' upper limits of the tower to  
' 400 cm.

**See Also:** UL 1050/1060, UL?

---

**UL?**

<b>Compatibility:</b>	1090, 2090	
<b>Description:</b>	Query the upper limit of the device. UL? returns the limit associated with the current polarization mode. The value returned is either in N1 (XXX) or N2 (XXX.X) format depending upon the current numeric mode. Negative values are preceded by a "-" minus sign.	
<b>Devices:</b>	Towers	
<b>Syntax:</b>	UL?	
<b>Response:</b>	[-]XXX[.X]	Value of the upper limit for the current polarization in centimeters.
<b>Example:</b>	CALL ibwrt (TowerUD%, "UL?")	' Query tower upper limit for ' current polarization
	CALL ibrd (TowerUD%, rdbuf\$)	' Read response
<b>See Also:</b>	UL 1050/1060, UL 1090/2090	

---

**UP**

<b>Compatibility:</b>	All	
<b>Description:</b>	Instructs the tower boom to move in the Up direction. This movement is limited by the upper limit.	
<b>Devices:</b>	Towers	
<b>Syntax:</b>	UP	
<b>Example:</b>	CALL ibwrt (TowerUD%, "UP")	' Instructs the boom of the ' tower to move up
<b>See Also:</b>	DN, ST	

---

**UV**

<b>Compatibility:</b>	2090	
<b>Description:</b>	Changes the upper limit of the device for vertical polarity. The specified value must be greater than the lower limit for vertical polarization and between -999.9 and 999.9. <i>NOTE: Unlike editing from the front panel, the Model 2090 allows setting the limit above the current position from the GPIB.</i>	
<b>Devices:</b>	Towers	
<b>Syntax:</b>	UV [+/-] XXX[.X]	Optional for positive values Necessary for negative values
	+	
	-	
	XXX[.X]	<b><i>Decimal value for the upper limit to be set in centimeters.</i></b>
		In N1 mode .X is ignored In N2 mode .X is optional. Leading zeros are optional.
<b>Example:</b>	CALL ibwrt (TowerUD%, "UV 355.5")	' Set vertical polarity upper ' limit to 355.5 cm
<b>See Also:</b>	UV?	



---

**UV?**

**Compatibility:** 2090  
**Description:** Queries the upper limit of the device for vertical polarity. The value returned is either in N1 (XXX) or N2 (XXX.X) format depending upon the current numeric mode. Negative values are preceded by a "-" minus sign.  
**Devices:** Towers  
**Syntax:** UV?  
**Response:** [-]XXX[X] Value of the upper limit for the vertical polarization in centimeters.  
**Example:** CALL ibwrt (TowerUD%, "UV?") ' Query vertical upper limit  
 CALL ibrd (TowerUD%, rdbuf\$) ' Read response  
**See Also:** UV

---

**VS?**

**Compatibility:** 2090 (Firmware Rev 3.00)  
**Description:** Queries the variable speed capability of the device.  
**Devices:** Towers, Turntables  
**Syntax:** VS?  
**Response:** <flag> Indicates if a device is capable of variable speed control:  
 1 Device supports variable speed  
 0 Device is not capable of variable speed control  
**Example:** CALL ibwrt (TowerUD%, "VS?") ' Is device variable speed?  
 CALL ibrd (TowerUD%, rdbuf\$) ' Read response

---

**WL**

**Compatibility:** 1050, 1060  
**Description:** Queries the turntable's clockwise limit. The value returned is either in N1 (XXX) or N2 (XXX.X) format depending upon the current numeric mode. Negative values are preceded by a "-" minus sign. *This command is obsolete.* On the models 1050 and 1060, this command changed the front panel to display the clockwise limit and prepared the controller to respond to all future reads with that limit. This is not compatible with the IEEE 488.2 standard; the program **must** send the WL command before each read. For programs which will not be used with a model 1050 or 1060, use the WL? command.  
**Devices:** Turntables  
**Syntax:** WL  
**Response:** [-]XXX[X] Value of the clockwise limit setting in degrees.  
**Example:** CALL ibwrt (TableUD%, "WL") ' Query turntable clockwise limit  
 CALL ibrd (TableUD%, rdbuf\$) ' Read response  
**See Also:** WL 1090/2090, WL?

---

---

**WL**

<b>Compatibility:</b>	1090, 2090	
<b>Description:</b>	Changes the clockwise limit of the device. The specified value must be greater than the counterclockwise limit and between -999.9 and 999.9. If in N1 mode any decimal is ignored and rounded to the nearest integer. <i>NOTE: Unlike editing from the front panel, the 2090 allows setting the limit above the current position from the GPIB.</i>	
<b>Devices:</b>	Turntables	
<b>Syntax:</b>	WL [+/-] XXX[X]	
	+	Optional for positive values
	-	Necessary for negative values
	XXX[X]	Decimal value for the clockwise limit to be set in degrees.
		In N1 mode .X is ignored
		In N2 mode .X is optional.
		Leading zeros are optional.
<b>Example:</b>	CALL ibwrt (TableUD%, "WL 90")	' Change CW limit of the ' turntable to 90 degrees.
	CALL ibwrt (TableUD%, "WL 359.9")	' Change CW limit of the ' turntable to 359.9 degrees.
<b>See Also:</b>	WL 1050/1060, WL?	

---

**WL?**

<b>Compatibility:</b>	1090, 2090	
<b>Description:</b>	Queries the turntable's clockwise limit. The value returned is either in N1 (XXX) or N2 (XXX.X) format depending upon the current numeric mode. Negative values are preceded by a "-" minus sign.	
<b>Devices:</b>	Turntables	
<b>Syntax:</b>	WL?	
<b>Response:</b>	[-]XXX[X]	Value of the clockwise limit setting in degrees.
<b>Example:</b>	CALL ibwrt (TableUD%, "WL?")	' Query turntable clockwise ' limit
	CALL ibrd (TableUD%, rdbuf\$)	' Read response
<b>See Also:</b>	WL 1050/1060, WL 1090/2090	

---

**ZERO**

<b>Compatibility:</b>	2090 (Firmware Rev 3.00)	
<b>Description:</b>	Initiates a zero reference scan for devices equipped with absolute zero reference pulses. See the <code>ZERO</code> parameter setting for more information.	
<b>Devices:</b>	Towers, Turntables	
<b>Syntax:</b>	ZERO	
<b>Example:</b>	CALL ibwrt (TableUD%, "ZERO")	' Initiate zero scan
<b>See Also:</b>	ZERO?	

---

## ZERO?

**Compatibility:** 2090 (Firmware Rev 3.00)

**Description:** Queries if the device is equipped with an absolute zero reference to determine if the ZERO command can be used.

**Devices:** Towers, Turntables

**Syntax:** ZERO?

**Response:**           <flag>           Value indicating if device supports zeroing.  
                          1           Device can execute ZERO function.  
                          0           Device does not support zeroing.

**Example:** CALL ibwrt (TowerUD%, "ZERO?")       ' Query zeroing capability

                  CALL ibrd (TowerUD%, rdbuf\$)       ' Read response

**See Also:**       ZERO

---



**\*ESR?**

**Description:** Query the Standard Event Status Register. This command readies the instrument to respond with the contents of the Standard Event Status Register when queried. The response is an integer in the range of 0 to 255. This value, when expressed in binary form, directly represents the bit values of the Standard Event Status Register. Note that upon reading this register, its contents will be cleared. The bit pattern of this register is given below.

**Devices:** Towers, Turntables

**Syntax:** \*ESR?

**Response:** XXX Integer value representing the bits of the Standard Event Status Register. The bit pattern is as follows.

0 - Operation Complete	Set when the Operation Complete has been armed by issuing *OPC and the device motion has stopped.
1 - Request Control	Unused. The 2090 does not have controller capability
2 - Query Error	Set when an attempt is made to read from the output queue when it is empty.
3 - Device Dependent Error	Set when a device dependent error occurs. These errors correspond to front panel error conditions. (See ERR?)
4 - Execution Error	Set when a valid GPIB command is received with parameters that are out of range, or when a device dependent error prevents execution of the command.
5 - Command Error	Set when an invalid GPIB command is received by the controller
6 - User Request	Unused. The 2090 does not support user request functions.
7 - Power On	Set when the Model 2090 is first powered on.

**Example:** CALL ibwrt (TowerUD%, "\*ESR?") ' Query and clear the Event Status Register  
CALL ibrd (TowerUD%, rdbuf\$) ' Read the response

**See Also:** ERR?, \*ESE, \*ESE?

**\*IDN?**

**Description:** Identification query. Determines the nature of device located at a given address on the GPIB bus. Prepares controller to respond with an ASCII character string when queried. The string returned ("EMCO,2090-XXX,0,REV N.NN") identifies this controller as a Model 2090. The XXX parameter is a place holder for the device type (TWR for towers and TT for turntables). The N.NN parameter is a place holder for the firmware revision level.

**Devices:** Towers, Turntables

**Syntax:** \*IDN?

**Response:** EMCO,2090-TWR,0,REV N.NN  
- or -  
EMCO,2090-TT,0,REV N.NN where N.NN is revision number

**Example:** CALL ibwrt (TableUD%, "\*IDN?") ' Query the identification string  
CALL ibrd (TableUD%, rdbuf\$) ' Read response

---

**\*OPC**

**Description:** Arm Operation Complete Flag. Causes the controller to set Operation Complete bit of the Standard Event Status Register when the current operation is complete (i.e. when the device stops moving).

**Devices:** Towers, Turntables

**Syntax:** \*OPC

**Example:** CALL ibwrt (TowerUD%, "\*OPC") ' Arm Operation Complete bit'

**See Also:** \*ESR?, \*OPC?

---

**\*OPC?**

**Description:** Query Operation Complete. Prepares controller to respond to a query with a single character message. If the device has completed its motion, the message returned is "1", otherwise it is "0". *(NOTE: This is a slight deviation from the ANSI/IEEE 488.2 standard for this command, which does not return a response until the operation is complete. That response is always "1". The current mode of operation is maintained for backwards compatibility with the Model 1090 controller.)*

**Devices:** Towers, Turntables

**Syntax:** \*OPC?

**Response:**

<flag>	Indicates if commanded motion is complete:
1	Motion is complete
0	Device is in motion

**Example:** CALL ibwrt (TableUD%, "\*OPC?") ' Query Operation Complete  
CALL ibrd (TableUD%, rdbuf\$) ' Read response

**See Also:** \*OPC, DIR?

---

**\*RST**

**Description:** Reset. Resets the controller. Controller remains in remote mode. All moving devices are immediately stopped, and the command queue is cleared. The state of the status register data structure remains unchanged.

**Devices:** Towers, Turntables

**Syntax:** \*RST

**Example:** CALL ibwrt (TableUD%, "\*RST") ' Reset turntable'

**See Also:** \*CLS

---

**\*SRE**

**Description:** Set Service Request Enable Register. Changes contents of the Service Request Enable Register. Requires an integer argument in the range of 0 to 255. This argument, when expressed in binary form, represents the value of the eight bit Service Request Enable Register. The bits of the argument (with the exception of bit 6 which is unused) correspond to the bits of the Status Byte Register. Setting a bit in this register allows the corresponding bit in the Status Byte Register to generate a Service Request.

**Devices:** Towers, Turntables

**Syntax:** \*SRE XXX  
XXX Integer value representing eight bit binary number 0-255

**Example:** CALL ibwrt (TableUD%, "\*SRE 32") ' Allow the Event Status Bit  
' to generate an SRQ

**See Also:** \*SRE?, \*STB?

---

**\*SRE?**

**Description:** *Query Service Request Enable Register. Prepares controller to respond with the contents of the Service Request Enable Register when queried. The value returned is a decimal number in the range of 0 to 255. This value when expressed in binary form, represents the value of the eight bit Standard Event Status Enable Register.*

**Devices:** Towers, Turntables

**Syntax:** \*SRE?

**Response:** XXX Integer value representing the setting of the Service Request Enable Register

**Example:** CALL ibwrt (TableUD%, "\*SRE?") ' Query the value of the SRE  
CALL ibrd (TableUD%, rdbuf\$) ' Read response

**See Also:** \*SRE

**\*STB?**

**Description:** Query Status Byte. Prepares the controller to respond to the contents of the Status Byte Register when queried. The value returned is a decimal in the range of 0 to 255. This value, when expressed in binary form, represents the eight bit value of the Status Byte Register. The value of this register is also returned in response to a serial poll, with the exception that the MSS bit is replaced by the value of the Request For Service (RQS) flag. The bit pattern of this register is as follows:

**Devices:** Towers, Turntables

**Syntax:** \*STB?

**Response:** XXX Integer value representing the bits of the Status Byte Register. The bit pattern is as follows.

0	- Device Dependent Error (DDE)	Set when the logical AND of the Device Dependent Error Register and the Device Dependent Error Enable Register is non-zero. This is a 2090/2190 specific status bit. (See ERR?)
1	- Undefined	
2	- Undefined	
3	- Undefined	
4	- Message Available (MAV)	Set when there is data in the device output queue waiting to be read over the GPIB.
5	- Event Status Bit (ESB)	Set when the logical AND of the Event Status Register and the Event Status Enable Register is non-zero.
6	- Master Summary Status (MSS)	<i>Set when the logical AND of the remaining bits of the Status Byte Register and the Status Byte Enable Register is non-zero.</i>
7	- Undefined	

**Example:** CALL ibwrt (TowerUD%, "STB?") ' Query status byte  
CALL ibrd (TowerUD%, rdbuf\$) ' Read response

**See Also:** ERR?, \*ESR?, \*SRE, \*SRE?

---

**\*TST?**

**Description:** Self Test. Prepares the controller to respond with a byte similar to self test result. Returned messages are always 0.

**Devices:** Towers, Turntables

**Syntax:** \*TST?

**Response:** 0 The 2090 always reports a passing self test.

**Example:** CALL ibwrt (TableUD%, "\*TST?") ' Query self test  
CALL ibrd (TableUD%, rdbuf\$) ' Read response

---

**\*WAI**

**Description:** Wait to Continue. Causes the controller to place execution of the next GPIB command on hold while there are devices in motion. Once motion has ceased, the next command is executed normally. While a command is on hold, additional commands are not accepted. Normal operation will continue after the command on hold had been executed. Time out of the GPIB bus must be disabled before execution of \*WAI command. The \*OPC commands are a more "program friendly" method of waiting for device motion to stop.

**Devices:** Towers, Turntables

**Syntax:** \*WAI

**Example:** CALL ibwrt (TowerUD%, "\*WAI") ' Wait for tower motion to  
' stop

**See Also:** \*OPC, \*OPC?



# APPENDIX B: MAINTENANCE

---



The following sections describe various field maintenance that may be performed on the Model 2090 Controller. *Maintenance should only be performed by qualified personnel.*

## NVRAM BATTERY BACKUP

---

The Model 2090 uses three 1.5V “AAA” alkaline batteries (type EN92 or equivalent) to maintain the current position, limits, and parameter settings in non-volatile RAM. To ensure reliable operation of the Model 2090, it is recommended that these batteries be replaced once a year. If the Model 2090 regularly reports an NVM initialization error (`ERR !`) this is an indication of dead batteries.

### INSTALLATION

The replacement batteries should only be installed by qualified personnel. Anti-static precautions should be maintained at all times. To reduce the risk of damage, the Model 2090 may be returned to ETS for upgrade, inspection, and test for a nominal fee. Contact the ETS Sales department for more information.

To replace the NVRAM batteries, perform the following steps.

1. It is recommended that you record all device parameter settings prior to replacing the batteries, since it may be necessary to re-configure the Model 2090 when done.

2. Disconnect all power and cables from the Model 2090 and move it to an open work area.
3. Use an anti-static wrist strap or other suitable ground to insure that you are properly grounded while you work.
4. Use a #2 Phillips screwdriver to remove the six screws (four on top, two along the back top edge) from the lid of the Model 2090 case. Slide the lid to the back of the Model 2090 to remove it.
5. Remove the three batteries and insure that the battery holder and contacts are clean and dry. Refer to the figure below to identify the location of various components on the Model 2090 main board. A “supercap” capacitor will normally maintain parameter settings for several minutes while the batteries are replaced.
6. Install three new 1.5V “AAA” alkaline batteries (type EN92 or equivalent), taking care to observe the polarity markings in the battery holder. Do not mix old and new batteries, or types of batteries. Use only alkaline batteries. *Failure to follow these directions may void the warranty.*
7. Slide the lid on from the back of the Model 2090 and replace the six mounting screws.



*NOTE: The four mounting screws on the lid may be different than the two on the back.*

8. Reconnect all cables and power up the Model 2090. After a moment, all of the indicators should flash and then the firmware revision will be displayed in the left display. If the batteries were dead, or removed for too long of a period, the unit may then display  $Err$  error in the left display indicating the NVRAM values have been reset to the factory defaults. If this occurs, refer to the list made in step one, or the parameter settings in the “Model 2090 Parameter List” section, to make any necessary changes based on your equipment configuration.

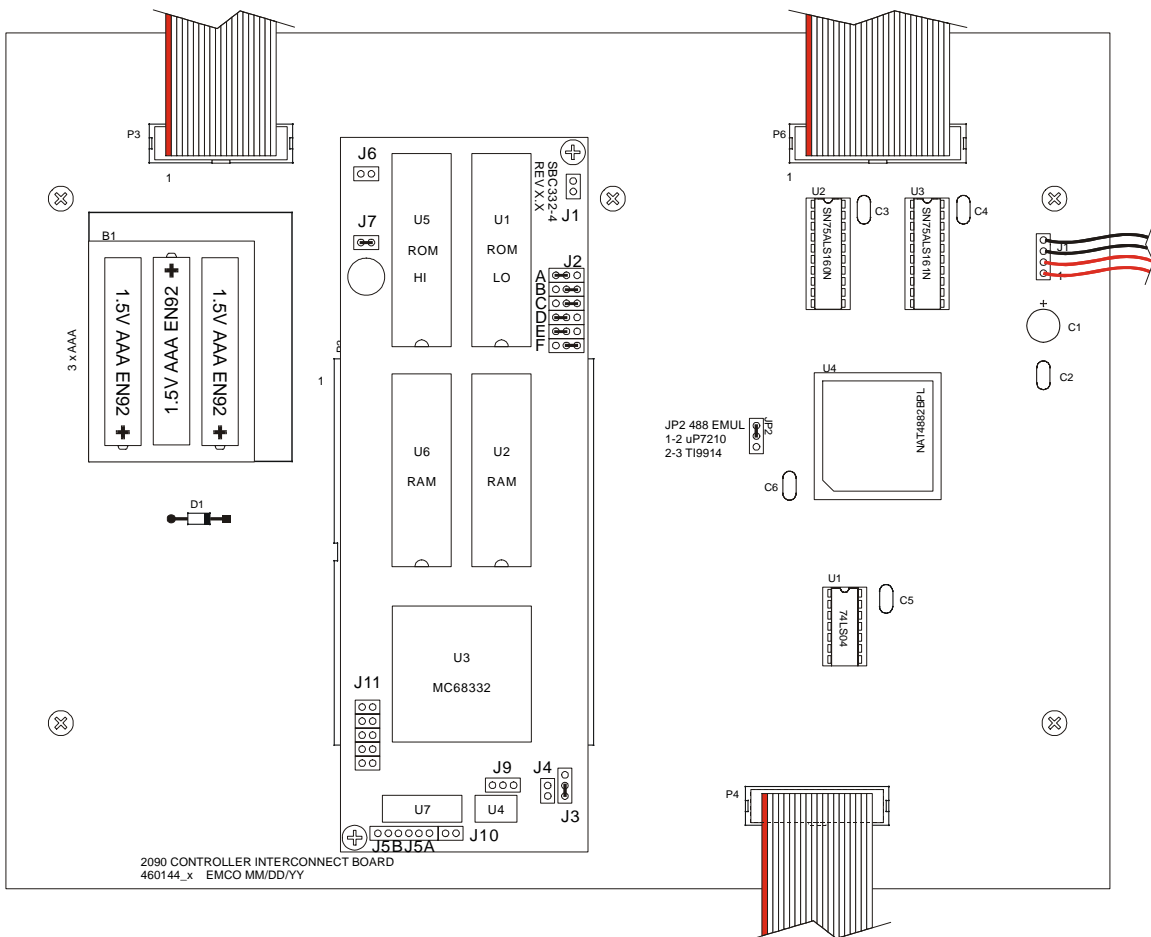

**Figure 7 Model 2090 Motherboard**

---

**CAUTION:** System will not function properly if jumper settings are not as shown on the previous page.

---

*NOTE: Should nonvolatile memory need re-initialization, remove the jumper from J7 for approximately five (5) seconds and then return it to its original position as shown on the previous page. This will return the controller to its original factory settings.*



*Disconnect power prior to performing this function. This function should only be performed by a qualified service technician.*

---

## INSTALLING FLASH ROMS

---

For users who receive this manual in conjunction with a firmware upgrade for their older Model 2090 controller, this section describes the necessary steps to determine compatibility and install the new flash upgradeable ROMs in the Model 2090. Users who have firmware revision 3.00 or later in their Model 2090 should not need to install new ROMs unless they do not have access to a GPIB interface. Refer to the section “Flash Upgrading the Model 2090” later in this Appendix for more information on flash upgrading the 2090.

### COMPATIBILITY

Most Model 2090s will be compatible with the flash ROMs. However, the oldest single board computers (SBCs) in Model 2090s manufactured prior to mid-to-late 1996 do

not offer flash upgrade support and will have to be replaced in order to provide full flash capability. In order to determine if a Model 2090 is flash compatible, remove the top cover and examine the single board computer. Refer to the illustrations on the next page to help identify which SBC version is installed. The critical component is J2. A flash compatible Model 2090 will have six sets of jumpers while the older boards will only have five. Incompatible boards may also be identified by a revision number less than 2.2 or by a socketed processor. Newer SBCs will have a revision number accompanied by the identifier “SBC332-4”. These SBCs are all flash compatible, even if the revision number is less than 2.2.

*NOTE: Old revision SBCs may be able to run the V3.00 firmware, but will not be able to be flash upgraded in circuit.*

If the Model 2090 contains an incompatible SBC, contact the ETS Sales department to purchase a new SBC, or to have ETS perform the upgrade.

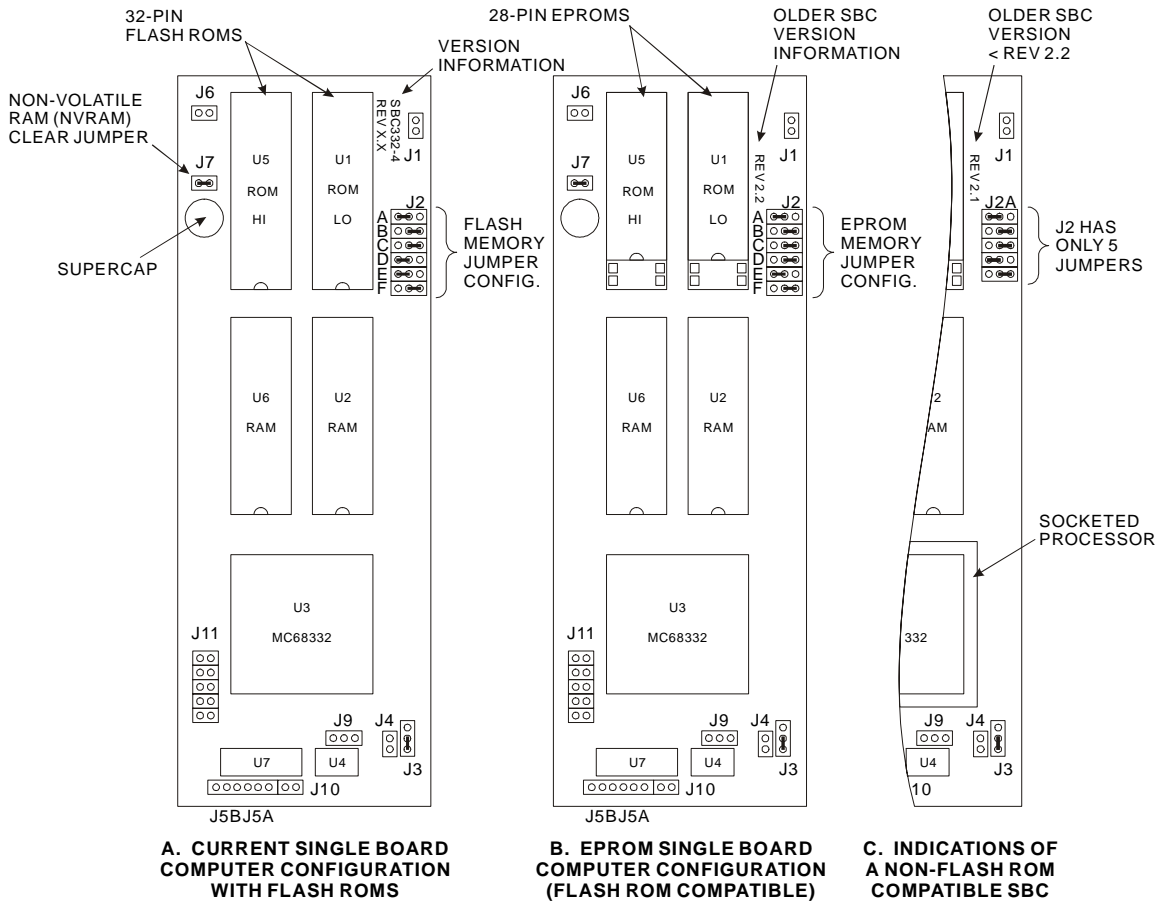

## INSTALLATION

The firmware upgrade should only be installed by qualified personnel. Anti-static precautions should be maintained at all times. To reduce the risk of damage, the Model 2090 may be returned to ETS for upgrade, inspection, and test for a nominal fee. Contact the ETS Sales department for more information.

To install the Model 2090 flash upgradeable firmware, perform the following steps.

1. It is recommended that you record all device parameter settings prior to performing the firmware upgrade, since it will be necessary to re-configure the Model 2090 when done.

2. Disconnect all power and cables from the Model 2090 and move it to an open work area.
3. Use an anti-static wrist strap or other suitable ground to insure that you are properly grounded while you work.
4. Use a #2 Phillips screwdriver to remove the six screws (four on top, two along the back top edge) from the lid of the Model 2090 case. Slide the lid to the back of the Model 2090 to remove it.
5. Remove the two mounting screws (if supplied) from the single board computer and gently lift the SBC out of its socket with a gentle rocking motion. It is not recommended that you attempt to replace the ROM chips with the SBC installed in the Model 2090.
6. Using an IC puller or another suitable device, gently remove the two EPROMs, U1 and U5, out of their sockets, taking care not to bend the pins, and place them on an anti-static pad. Gently pry at both ends, or pry one end up slightly and insert the device completely under the chip to the other end. Avoid prying one end all the way out as damage to the IC pins and/or socket may occur.
7. Noting the orientation of the notch on the flash ROMs, insert each one oriented as shown in the figure on the previous page. Refer to the label on the chips to identify the HI and LO bank ROMs, but do not use the

labels for orientation. Gently place each chip in its socket and insure that all pins are properly positioned. It may be necessary to slightly bend the pins inward to align them properly. Make sure that all pins are properly aligned in their sockets and then use a firm pressure to push the ROM into its socket until seated. Repeat the procedure with the second ROM.

8. To configure the SBC for the flash ROM, move jumper J2-D from the right (pins 2 and 3) to the left (pins 1 and 2) side of the bank. The jumpers should be arranged as shown in configuration A as illustrated above.

*NOTE: If you fail to make this change, the Model 2090 will operate normally, but will not be flash upgradeable.*

9. Carefully align the SBC in its socket and push down firmly until seated. Re-install the holding screws if provided.

*NOTE: If the three "AAA" batteries in the Model 2090 have not been replaced in the past year, this would be a good time to do so.*

10. Slide the lid on from the back of the Model 2090 and replace the six mounting screws.

*NOTE: The four mounting screws on the lid may be different than the two on the back.*



11. Reconnect all cables and power up the Model 2090.

After a moment, all of the indicators should flash and then the firmware revision will be displayed in the left display. The unit will then display `EEP |` error in the left display indicating the NVRAM values have been reset to the factory defaults. Refer to the list made in step one, or the parameter settings in the “Model 2090 Parameter List” section, to make any necessary changes based on your equipment configuration.

## **TROUBLESHOOTING**

If your Model 2090 fails to function correctly, first check all power and fiber connections. If the Model 2090 power light comes on, but the display and indicators never flash on or show the revision number, check that the SBC is firmly seated, that the ROMs are installed in the correct sockets (HI vs. LO) and orientation (notch indicating pin one facing towards the front of the Model 2090) and that all IC pins are properly seated in their sockets. If the Model 2090 powers on and shows “`FLASH [C]dE`” in the display, this indicates that the Model 2090 is in bootstrap mode awaiting a flash upgrade. Either the bootstrap code detected invalid firmware upon power up, or there is a problem with the Model 2090 front panel. Power the unit off and back on to see if the problem persists. If so, you can try downloading the flash upgrade file for the Model 2090 and restoring the corrupted ROM, or contact ETS for assistance. If the Model 2090 powers on normally but only shows dashed lines (“-----”) in the displays, insure that the fiber optics to the device(s) are connected correctly

(out-to-in and in-to-out) and that the device(s) are powered on.

If none of these options corrects the problem, it may also be necessary to insure that no cables inside the Model 2090 were disconnected or knocked loose during the installation. If the problem still persists, try replacing the original EPROMs and jumper settings to verify the Model 2090 still works normally. The SBC may not be compatible with the new firmware. Contact ETS for additional assistance.

### **VARIABLE SPEED DEVICES**

V3.11 of the Model 2090 firmware contains additional enhancements for variable speed devices. To take advantage of all of these enhancements, the variable speed motor base (MB-IV) firmware revision must be at V1.10a or later. Use the new BASE parameter in the parameter menu to determine the firmware revision (and to verify that the motor base has a flash upgradeable MB-IV board). Go to [www.ets-lindgren.com](http://www.ets-lindgren.com) or contact ETS-Lindgren to obtain the motor base flash upgrade.

---

**WARNING:** *Under no circumstances should a motor base with firmware revision less than V1.04 be updated. Firmware versions earlier than V1.04 indicate an earlier revision interface board which is incompatible with firmware revisions V1.04 or later. If you determine you have an MB-IV motor base with an earlier revision, contact ETS for more information.*

---

*NOTE to 2088 and 5901 users: Upgrading older 2088 or 5901 motor bases to V1.10a will likely cause a change in performance, slightly increasing the maximum speed. This increase in speed may also affect positioning accuracy. If you encounter difficulties after upgrading to V1.10a, contact ETS for additional information on possible adjustments to your 2088 or 5901 motor base.*

## **FLASH UPGRADING THE MODEL 2090**

---

The Model 2090 with firmware revision 3.00 or later supports flash upgrades over the GPIB interface. This feature allows the Model 2090 to be upgraded to the current firmware revision without the need of replacing the PROMs inside the unit. As revisions become available, both the firmware and upgrade utility will be made available for download from the ETS-Lindgren web site at [www.ets-lindgren.com](http://www.ets-lindgren.com).

### **COMPATIBILITY**

At the time of this writing, the upgrade utility is designed to support the National Instruments line of GPIB cards under Microsoft Windows 3.1, 95/98/ME, and NT 4.0/2000. Contact ETS-Lindgren for information regarding possible support for a different MS Windows compatible interface card. If a supported card and operating system is unavailable, it will be necessary to purchase and install replacement PROMs or send the unit back to ETS-Lindgren for upgrade.

## INSTALLATION AND UPGRADING

Refer to any documentation provided with the flash upgrade utility for the latest version of these instructions. The Universal Device Controller (UDC) Firmware Upgrade Utility (FLASHUDC.EXE) is designed to upgrade several different device controllers in the ETS-Lindgren product line. Thus, it may be made available online separate from the actual flash upgrade file for the Model 2090. Always use the latest version of the upgrade utility, since file formats and other features may change with new firmware revisions. Be sure to read all instructions prior to beginning the flash upgrade. It is recommended that the parameter settings be recorded prior to beginning the upgrade in case they need to be restored after the upgrade process.

Unzip or install the UDC Firmware Upgrade Utility and the Model 2090 firmware flash upgrade (.FSH) file, including any associated files included with them, to the same directory. Make sure the Model 2090 is connected to the GPIB interface and powered on. Start the upgrade utility by double clicking on the executable's icon. If necessary, select the appropriate GPIB address in the "GPIB Port" drop down.

When communicating properly, the program will display the current firmware type (EMCO Model), status, and version in the "UDC Firmware Information" group. If the "Firmware Upgrade File" box does not show the name of the appropriate file, press the "Browse..." button to find the flash upgrade file. The "Upgrade Version" edit box will

show the target version from the upgrade file. The boxes under “UDC Firmware Information” will also indicate if there are any problems or incompatibilities between the program, the upgrade file, and the device to be upgraded. Refer to the following figure for a typical screen.

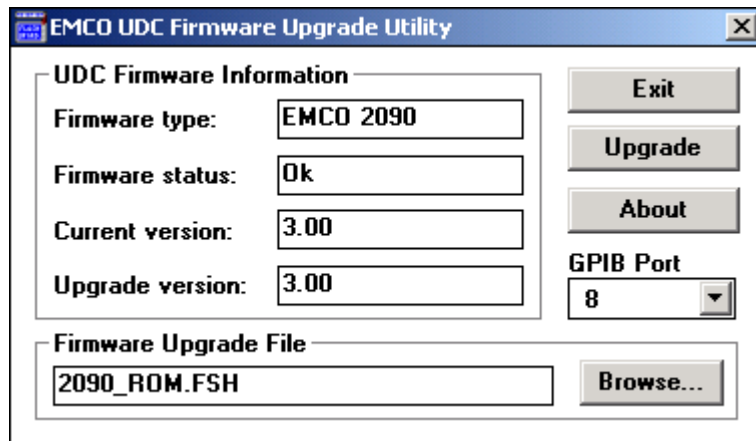

**Figure 8 Universal Device Controller Upgrade Utility**

Press the “Upgrade” button to initiate the upgrade process. The flash upgrade file may contain additional documentation encoded into it, which will be displayed prior to starting the upgrade process. Once the upgrade is initiated, the Model 2090 will reset itself, entering a “bootstrap” mode, which will handle the actual upgrade of the firmware. The Model 2090 will display the bootstrap code revision level, such as “FLASH r 100” followed by “FLASH CODE” in the displays. The program should immediately start the download, displaying the status in a dialog. The Model 2090 will also report its status by displaying the percentage complete in the right hand display window.

**WARNING:** *Do not cycle power or otherwise interrupt the firmware download process, or memory corruption will result, possibly requiring a return to the factory for repair.*

Should the upgrade fail for any reason, the Model 2090's operating firmware will be corrupt. The Model 2090 should power on in bootstrap mode to allow the upgrade to be attempted again. If not, contact ETS-Lindgren for assistance.

Once the upgrade is complete, the Model 2090 will restart, booting into the new firmware. Changes in the firmware may cause the parameter settings to be invalid, resulting in an initialization error "E000!". If so, refer to the list made before starting, or the parameter settings in the "Model 2090 Parameter List" section, to make any necessary changes based on your equipment configuration.

## FLASH UPGRADING MOTOR BASES

The new Motor Base Series V (MB-V) fiber optic interface and control boards support flash upgrades to their firmware and programmable logic. This provides a very versatile means of enhancing the behavior of the product even after installation, without needing to access the interface board itself. The Model 2090 with firmware revision 3.11 or later supports these flash upgrades by allowing the new motor base firmware to be downloaded to it over the GPIB interface. As revisions become available, both the firmware and upgrade utility will be made available for

download from the ETS-Lindgren web site at [www.ets-lindgren.com](http://www.ets-lindgren.com).

### **MB-V IDENTIFICATION**

The MB-V interface can be identified visually by the control board enclosure mounted on the outside of the motorbase with two (2) metal fiber-optic connectors extending parallel to the main enclosure. From the Model 2090, use the new BASE parameter in the parameter menu to verify that the motor base has a flash upgradeable MB-IV board and to determine the existing firmware revision.

---

**WARNING:** *Under no circumstances should a motor base with firmware revision less than V1.04 be updated. Firmware versions earlier than V1.04 indicate an earlier revision interface board which is incompatible with firmware revisions V1.04 or later. If you determine you have an MB-IV motor base with an earlier revision, contact ETS for more information.*

---

*NOTE to 2088 and 5901 users: Upgrading older 2088 or 5901 motor bases will likely cause a change in performance, slightly increasing the maximum speed. This increase in speed may also affect positioning accuracy. If you encounter difficulties after upgrading, contact ETS for additional information on possible adjustments to your 2088 or 5901 motor base.*

## COMPATIBILITY

The upgrade utility is designed to support the National Instruments line of GPIB cards under Microsoft Windows XP/2000. Contact ETS-Lindgren for information regarding possible support for a different MS Windows compatible interface card. If a supported card and operating system is unavailable, it will be necessary to purchase and install an updated MB-V interface, or send the unit back to ETS-Lindgren for upgrade.

## INSTALLATION AND UPGRADING

Refer to any documentation provided with the MB-V flash upgrade utility for the latest version of these instructions. Always use the latest version of the upgrade utility, since file formats and other features may change with new firmware revisions. Be sure to read all instructions prior to beginning the flash upgrade.

Unzip or install the MB-V flash upgrade utility and the motor base firmware flash upgrade (.mot) file, including any associated files included with them, to the same directory. Make sure the Model 2090 is connected to the GPIB interface and powered on. Start the upgrade utility by double clicking on the executable's icon. If necessary, select the appropriate GPIB address in the "Port" drop down. *(NOTE: The SBC Upgrade Utility also supports upgrading through an ETS-Lindgren Virtual Controller Interface Device, so the PC serial ports are also available in the drop down list.)*



When communicating properly, the program will display the current interface type in the “Interface Type:” window and the SBC device type, status, and firmware version in the “SBC-V Information” group. When using the Model 2090 as the interface, the bootstrap revision will not be shown. If the “Upgrade File” box does not show the name of the appropriate file, click on the folder button next to the filename box to find the flash upgrade file. The “Upgrade Version” edit box will show the target version from the upgrade file. The boxes under “SBC-V Information” will also indicate if there are any problems or incompatibilities between the program, the upgrade file, the interface, and the device to be upgraded. Refer to the following figure for a typical screen.

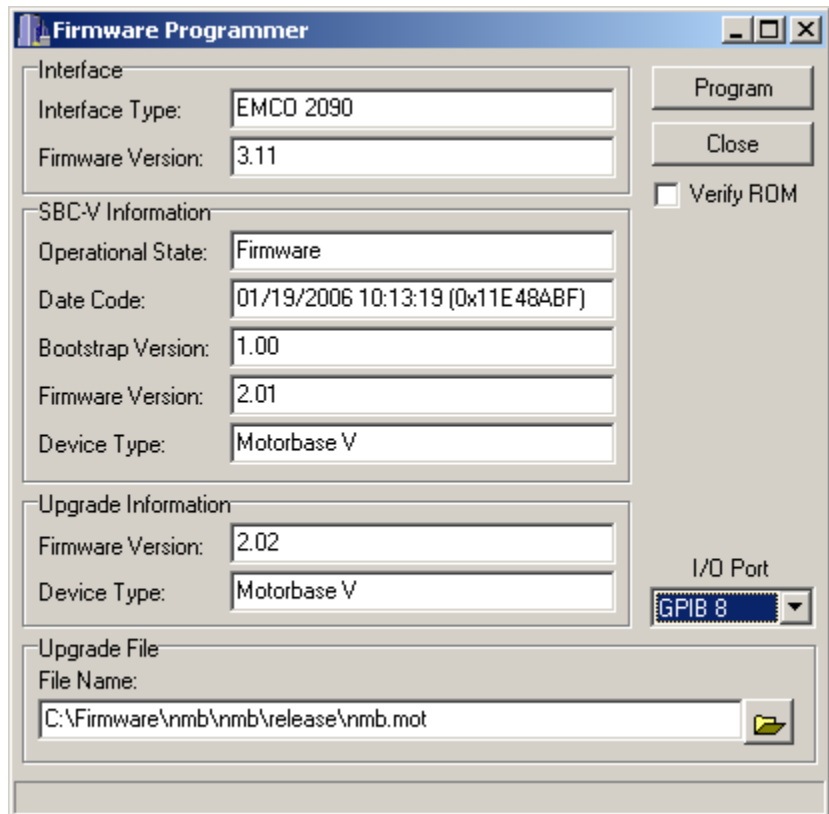

**Figure 9 MB-V Flash Upgrade Utility**

Press the “Program” button to initiate the upgrade process. The flash upgrade file may contain additional documentation encoded into it, which will be displayed prior to starting the upgrade process. Once the upgrade is initiated, the program will display the upgrade status in a dialog and the Model 2090 will display the status of the upgrade in the associated device window. The Model 2090 will display “bEG In” as the program negotiates with the controller and motor base, “F lE” to indicate it is receiving the upgrade file from the program, “ChEcH” as it performs some functional checks on the motor base interface board, “PrOg” as it sends the firmware data to the motor base, “UEr lF” as it verifies the motor base received the file properly, and “SAUE” as it commands the motor base to store the data to EEPROM and restart. **WARNING:** *Do not cycle power or otherwise interrupt the firmware download process, or memory corruption will result, possibly requiring a return to the factory for repair.* Should the upgrade fail for any reason, the motor base operating firmware will be corrupt. As long as the interruption occurred prior to the “SAUE” cycle, cycling power on the motor base should restore it to normal operation. If not, contact ETS-Lindgren for assistance.

Once the upgrade is complete, the motor base will restart, booting into the new firmware. The Model 2090 will typically indicate a communication lost (E007) error momentarily until the motor base restores communication. If the Model 2090 does not automatically recover

communication with the motor base, it may be necessary to cycle power on the Model 2090, the motor base, or both.

This page intentionally left blank.

# APPENDIX C: MODEL 2090 ERROR CODE REFERENCE

---

---

## ERROR CODES

---

### RECOVERABLE ERRORS:

The following errors indicate a recoverable problem that may require user intervention. These errors can be cleared by pressing any key on the front panel to acknowledge the error. These errors can also be cleared remotely through the GPIB Status reporting structure described in “GPIB Status Reporting” under “Using the GPIB Command Set with the Model 2090.

---

<i>E001</i>	NVM Initialization Error. Parameter settings were lost and restored to factory defaults. This error usually indicates that the NVM backup batteries are dead and should be replaced. See the procedure in the section “NVRAM Battery Backup” in Appendix B: Maintenance, for more information.
<i>E002</i>	Motor not moving.
<i>E003</i>	Device Will Not Stop: Device did not respond to stop command.
<i>E004</i>	Device Moving In the Wrong Direction.
<i>E005</i>	Hard Limit: Device has reached a mechanical limit.
<i>E006</i>	Polarization limits violation.
<i>E007</i>	Communication lost.
<i>E008</i>	Flotation violation.
<i>E009</i>	Encoder failure.
<i>E010</i>	Trigger error.
<i>E011</i>	Overheat.
<i>E012</i>	Relay failure.

---

**SYSTEM TEST FAILURES:**

The following errors are of a more serious nature and may indicate that service is needed. In the event of such an error, power off the unit for several seconds and power it back on. If the error recurs, contact ETS-Lindgren for service.

<i>E 100</i>	ROM test error: ROM has been detected as being corrupt.
<i>E 101</i>	RAM test error: RAM has been detected as being corrupt.
<i>E 102</i>	NVM test error: NVM has been detected as being corrupt.
<i>E 103</i>	Low Power Test error: Power test failed.
<i>E 104</i>	GPIB Test error: GPIB test failed.

**HARDWARE ERRORS:**

The following errors are not limited to the startup process, and should not occur under normal operation. In the event of such an error, power off the unit for several seconds and power it back on. If the error recurs, contact ETS-Lindgren for service.

<i>E996</i>	BERR Error
<i>E997</i>	Uninitialized Interrupt
<i>E998</i>	Spurious Interrupt
<i>E999</i>	Invalid Interrupt Error

**TROUBLESHOOTING ERROR CODES**

Error codes *E001-E007* may be cleared by pressing any key and correcting the reported condition. The errors *E 100-E 104* and *E996-E999* should be recorded and noted as to what action brought about the error. If resetting the machine does not clear the error and allow normal operation, the error should be reported to ETS-Lindgren for prompt attention.

The following table gives typical causes for the recoverable errors:

---

<b>E001</b>	<p><b>NVM Initialization Error</b></p> <p>This error indicates that the Model 2090's parameter settings were lost and restored to factory defaults. This usually indicates that the NVM backup batteries are dead and should be replaced. See the procedure in the section "NVRAM Battery Backup" in Appendix B: Maintenance, for more information.</p>
<b>E002</b>	<p><b>Motor Not Moving</b></p> <p>This error typically indicates that either the device is too overloaded to operate correctly, or that there is a mechanical or electrical failure in the controlled device. On variable speed devices, it may also indicate that the factory preset minimum speed is too low for the operating load (such a case will typically be indicated by the device stopping just short of the target position and reporting an <b>E002</b>). It's also possible to have the minimum speed below the error detection threshold of the Model 2090, so that although the device is moving, it is moving too slow to prevent the error. In some cases, especially on older devices, it may also be reported after or in place of an <b>E005</b> indicating that the motor is stopped due a hardware limit.</p>

---

The devices attached to the Model 2090 use optical encoders to record the current position of the device and to verify motion. A failure in the encoder or the connections between the encoder and motor drive will also cause an **E002** even though the device may actually be moving. The following diagnostic procedure will greatly aid in identifying the source of the problem:

**WARNING:** *Appropriate care should be taken when attempting any diagnostic procedure. These devices may pose electrical and mechanical hazards when in operation. Tests should only be performed by qualified personnel. This procedure is provided for informational purposes only. ETS-Lindgren cannot be held responsible for any loss or injury due to the use or misuse of this information.*

First, it is important to determine if the device actually moves when commanded. If the device moves

---

---

normally, but the display does not change, or changes randomly, this usually indicates a failure of the encoder, its electrical connection to the interface and control board, or the mechanical linkages between the encoder and the motor. Note that these linkages also typically drive the mechanical limits, if equipped, so care should be taken to insure that the device is not moved far enough to cause mechanical damage when the Model 2090 is not indicating motion.

If this is not the case, make sure that the Model 2090 is actually indicating that device motion is allowed. The associated indicator should light with the **UP/CW** or **DOWN/CCW** key is pressed. If so, the Model 2090 should again report an `E002` after a few seconds.

If the device does not move at all when commanded, it may be overloaded. To verify that this is a device failure, first remove or reduce the load and attempt motion again. If the device operates correctly, verify that the applied load is within the specifications of the device.

If the device will not move at all with the load removed, check the power to the motor. Some devices (heavy-duty turntables, etc.) have separate circuit breakers for the motor and control electronics. There may also be separate breakers in the facility wiring which could be tripped. In addition, some variable speed devices have variable frequency drives with their own overload safety trips. It may be necessary to cycle the power on a variable speed device to reset this circuit.

If the device has power, listen for a hum or buzz from the motor when the device is commanded to move. This may indicate that the device is mechanically stalled, or that there is a power problem to one or more of the motor windings. Depending on the device, this could include failed solid state relays (a possible side effect of storms or power surges), a bad start capacitor, a bad leg of a three phase power system, or a bad winding in the motor itself.

Finally, it's possible that the low voltage control signals from the interface and control board are not getting to the motor control relays or drive.

---



---

**E003 Device Will Not Stop**

This error indicates that the device is still moving several seconds after the motor has been deactivated. If this error occurs and the device continues moving under its own power, remove power from the device immediately and contact ETS-Lindgren for service.

This error is more often caused by excessive overshoot of a device. Such overshoot may be an indication of an overloaded device or the failure or degradation of the motor brake for devices so equipped. An example of such a case would be a tower for which the cross boom carrier continues moving in the down direction after device motion has been stopped.

This error may also occur in conjunction with an E002 or an E005, being reported after the previous error is cleared. This is simply a side effect of the other error condition preventing the Model 2090 from detecting the motor stopping.

---

**E004 Device Moving In the Wrong Direction**

This error indicates that the device has moved too far in the direction opposite the direction commanded. On towers, this error can be caused due to an overloaded cross boom, or a weak brake, where the carrier moves down under the force of gravity before moving up. For devices with split-phase motors (towers and light duty turntables) this error can also be caused by reducing the reverse delay ( $PB$ ) below an acceptable value. Split phase motors must come to a complete stop before reversing directions.

On a new installation, there is the possibility that the device was mis-wired at the time of installation, especially for assemblies where the control and motor portion are shipped disassembled. For these cases, note that this error will be generated if either the motor or the encoder are mis-wired. (If both are mis-wired, the error will not be generated but the device will always move in the wrong direction! In the case of a mis-wiring at installation, the limit switches (if so equipped) should also be checked to verify they are wired correctly.) In addition, heavy-duty devices using three-phase motors will reverse direction if any phase of the power is switched. Thus, changes in facility wiring can also

---

---

cause this problem.

On split phase motors, a failure of the start capacitor or start winding may also cause this error. Failure of drive relays, the encoder, or bad connections between the interface/control board and the rest of the electronics may also be causes.

---

**E005 Hardware Limit Hit**

This indicates that the device has reached a mechanical limit. The hardware limits are intended as an emergency safety limit to prevent mechanical damage and should not be encountered under normal operation. For proper operation, the hardware limits should always be adjusted to be at least 10-15 centimeters or degrees beyond the software limits of the Model 2090. Once engaged, hysteresis of the mechanical limit switch assembly will typically prevent motion in the limit direction until the device has been moved far enough away from the limit to allow it to disengage. On some devices this can be as much as 20-30 cm/degrees.

Most current devices equipped with limit switches have knobs for adjusting the limits mounted either on the side of the motor base or in a box mounted under the turntable. Other devices, such as the Model 2065 LoPro Turntable, have the limit switches permanently fixed and the device must be adjusted to run between those limits. A new limit switch assembly being introduced will use optical interrupters behind a small removable cover.

---

**E006 Polarization Limits Violation**

This error indicates that an attempt was made to change the polarization of the tower cross boom while the antenna was outside the software limits for the target polarization. In order to protect the antenna from damage, the Model 2090 will prevent the tower from changing polarization and generate this error condition. See the section on “Polarization Violation and Limits” in the “Operation” chapter for more information.

---

---

**E007 Communication Lost**

This indicates that the Model 2090 has lost communication with the motor base. This is the only automatically recoverable error, where, if communication is restored, the Model 2090 will automatically clear the error condition. If the user clears the error and communication has not been restored, the Model 2090 will indicate an offline condition by displaying five dashes (-----) in the display. The Model 2090 may also switch from the offline display to the “E007” if a program sends GPIB commands in an attempt to communicate with a device.

This error, or the offline condition, can be caused by power loss at the device (including a blown fuse on the motor base); reversed fiber optic connections (must be IN to OUT and OUT to IN); a bad or broken fiber or fiber optic connector; or an electronic failure of the device. Verify that a small red light can be seen coming out of the OUT connectors on both the interface panel of the motor base and the back of the Model 2090. Verify that a pinpoint of red light can be seen coming out of the fiber going into the IN ports of the motor base and Model 2090 (while connected to the OUT port at the other end). It may be necessary to cup a hand around the fiber to detect this point of light. Note that even if the light is visible, there may still be a break in the fiber that reduces the light received below that which the devices can register, or which may cause intermittent operation. If available, try switching to another fiber optic cable if nothing else works. Finally, try cycling power to the device and the Model 2090 to reset the electronics.

Unlike older versions of the Model 2090 firmware, this version is now capable of recovering from a communication loss at any time, as well as detecting when a device is attached or powered on after the Model 2090 is powered on. However, it is still recommended that the motor base be powered on before the Model 2090.

---

**E008 Flotation Violation**

For air flotation turntables, this error indicates that an attempt was made to manually deflate the table while it was in motion. The Model 2090 will not allow this to occur and warns the user by displaying this error.

---

---

**E009 Encoder Failure**

This error indicates that the Model 2090 has detected behavior indicative of an encoder problem. These behaviors include large jumps in reported position and intermittent small reverses in direction (below the Moving Wrong Direction threshold). These problems could be caused by a failing encoder, bad electrical connections between the encoder and the control/interface board, or an electrical noise problem introducing stray signals onto the encoder lines (typically due to faulty grounding between the encoder and control box).

---

**E010 Trigger Failure**

This error indicates that the Model 2090 has detected an overflow in the trigger queue register.

---

**E011 Overheat Error**

This error indicates that the Model 2090 has detected that either the motor or control board has exceeded the corresponding maximum temperature. This could be due to environmental factors or excess mechanical drag on the system. Check what the current temperature is for both the motor and control board displayed in the 2090 parameter list and contact customer service.

---

**E012 Relay Failure**

This error indicates that the Model 2090 has detected the motor drive relays are not switching properly. This error will usually occur in combination with an E002 motor not moving error. Contact customer service to determine the cause of this error.

---

**---- Device Offline**

- This indicates that the Model 2090 cannot find a device to communicate with over the associated device interface. Refer to E007 above for diagnostic suggestions.

---

# APPENDIX D: PARAMETER SETTINGS

## PARAMETER SETTING FOR AMS-8050 AND 2188 SERIES MAPS

Parameter	Device 1 – Turntable Theta Axis	Device 2 – Mast Upper Rotation Phi Axis
P1	0	0
P2	0	0
P3	000	000
P5	1	1
P8	0.1	0.1
P9	8	9
B1	000	000
C	4500	4500
SO	-1	-1
S1	31	31
S2	63	63
S3	95	95
S4	127	127
S5	159	159
S6	191	191
S7	223	223
S8	255	255
Ac	2.0	2.0
OC	OFF	OFF

This page intentionally left blank.

# WARRANTY STATEMENT:

## Scope and Duration of Warranties

Seller warrants to Buyer that the Standard EMCO Brand Products Excluding 5211 & 5220 be (1) free from defects in material, manufacturing workmanship, and title, and (2) conform to the Seller’s applicable product descriptions and specifications, if any, contained in or attached to Seller’s quotation. If no product descriptions or specifications are contained in or attached to the quotation, Seller’s applicable product descriptions and specifications in effect on the date of shipment shall apply. The criteria for all testing shall be Seller’s applicable product specifications utilizing factory-specified calibration and test procedures and instruments.

All product warranties, except the warranty of title, and all remedies for warranty failures are limited in time as shown in the table below.

Product Warranted	Duration of Warranty Period
Standard EMCO Brand Products Excluding 5211 & 5220	2 Years

Any product or part furnished to Buyer during the warranty period to correct a warranty failure shall be warranted to the extent of the unexpired term of the warranty applicable to the repaired or replaced product.

The warranty period shall commence on the date the product is delivered to Buyer; however, if Seller assembles the product, or provides technical direction of such assembly, the warranty period for such product shall commence on the date the assembly of the product is complete. Notwithstanding the foregoing, in the event that the assembly is delayed for a total of thirty (30) days or more from the date of delivery for any reason or reasons for which Seller is not responsible, the warranty period for such product may, at Seller’s options, commence on the thirtieth (30th) day from the date such product is delivered to Buyer. Buyer shall promptly inspect all products upon delivery. No claims for shortages will be allowed unless shortages are reported to Seller in writing within ten (10) days after delivery. No other claims against Seller will be allowed unless asserted in writing within thirty (30) days after delivery (or assembly if the products are to be assembled by Seller) or, in the case of alleged breach of warranty, within the applicable warranty period.

## Warranty Exclusions

Except as set forth in any applicable patent indemnity, the foregoing warranties are exclusive and in lieu of all other warranties, whether written, oral, express, implied, or statutory. EXCEPT AS EXPRESSLY STATED ABOVE, SELLER MAKES NO WARRANTY, EXPRESS OR IMPLIED, BY STATUTE OR OTHERWISE, WHETHER OF MERCHANTABILITY OR FITNESS FOR ANY PARTICULAR PURPOSE OR USE OR OTHERWISE ON THE PRODUCTS, OR ON ANY PARTS OR LABOR FURNISHED DURING THE SALE, DELIVERY OR SERVICING OF THE PRODUCTS. THERE ARE NO WARRANTIES WHICH EXTEND BEYOND THE DESCRIPTION ON THE FACE HEREOF.

Warranty coverage does not include any defect or performance deficiency (including failure to conform to product descriptions or specifications) which results, in whole or in part, from (1) negligent storage or handling of the product by Buyer, its employees, agents, or contractors, (2) failure of Buyer to prepare the site or provide an operating environmental condition in compliance with any applicable instructions or recommendations of Seller, (3) absence of any product, component, or accessory recommended by Seller but omitted at Buyer's direction, (4) any design, specification, or instruction furnished by Buyer, its employees, agents or contractors, (5) any alteration of the product by persons other than Seller, (6) combining Seller's product with any product furnished by others, (7) combining incompatible products of Seller, (8) interference with the radio frequency fields due to conditions or causes outside the product as furnished by Seller, (9) improper or extraordinary use of the product, or failure to comply with any applicable instructions or recommendations of Seller, or (10) acts of God, acts of civil or military authority, fires, floods, strikes or other labor disturbances, war, riot, or any other causes beyond the reasonable control of Seller. This warranty does not cover (1) contact fingers or replacements unless loss is caused by a defect in material or manufacturing workmanship within the scope of this warranty (2) items designed to be consumable and (3) removal and reconstruction of walls, partitions, ceilings and other facility costs arising from repair or replacement of the product or parts thereof by Seller under the warranty. Seller does not warranty products of others which are not included in Seller's published price lists for shielding products and systems supplies and accessories.



## Buyer's Remedies

If Seller determines that any product fails to meet any warranty during the applicable warranty period, Seller shall correct any such failure by either, at its option, repairing, adjusting, or replacing without charge to Buyer any defective or nonconforming product, or part or parts of the product. Seller shall have the option to furnish either new or exchange replacement parts or assemblies.

Warranty service during the applicable warranty period will be performed without charge to Buyer within the contiguous 48 United States during Seller's normal business hours. After the warranty period, service will be performed at Seller's prevailing service rates. Subject to the availability of personnel, after-hours service is available upon request at an additional charge. For service outside the contiguous 48 United States, travel and per diem expenses, when required, shall be the responsibility of the Buyer, or End User, whichever is applicable.

The remedies set forth herein are conditioned upon Buyer promptly notifying Seller within the applicable warranty period of any defect or non-conformance and making the product available for correction.

The preceding paragraphs set forth Buyer's exclusive remedies and Seller's sole liability for claims based on failure of the products to meet any warranty, whether the claim is in contract, warranty, tort (including negligence and strict liability) or otherwise, and however instituted, and, upon the expiration of the applicable warranty period, all such liability shall terminate. IN NO EVENT SHALL SELLER BE LIABLE TO BUYER FOR ANY SPECIAL INDIRECT, INCIDENTAL OR CONSEQUENTIAL DAMAGES OF ANY KIND ARISING OUT OF, OR AS A RESULT OF, THE SALE, DELIVERY, NON-DELIVERY, SERVICING, ASSEMBLING, USE OR LOSS OF USE OF THE PRODUCTS OR ANY PART THEREOF, OR FOR ANY CHARGES OR EXPENSES OF ANY NATURE INCURRED WITHOUT SELLER'S WRITTEN CONSENT DESPITE ANY NEGLIGENCE ON BEHALF OF THE SELLER. IN NO EVENT SHALL SELLER'S LIABILITIES UNDER ANY CLAIM MADE BY BUYER EXCEED THE PURCHASE PRICE OF THE PRODUCT IN RESPECT OF WHICH DAMAGES ARE CLAIMED. This agreement shall be construed in accordance with laws of the State of Illinois. In the event that any provision hereof shall violate any applicable statute, ordinance, or rule of law, such provision shall be ineffective to the extent of such violation without invalidating any other provision hereof.

Any controversy or claim arising out of or relating to the sale, delivery, nondelivery, servicing, assembling, use or loss of use of the products or any part thereof or for any charges or expenses in connection therewith shall be settled in Austin, Texas by arbitration in accordance with the Rules of the American Arbitration Association, and judgment upon the award rendered

by the Arbitrator may be entered in either the Federal District Court for the Western District of Texas or the State District Court in Austin, Texas, all of the parties hereto consenting to personal jurisdiction of the venue of such court and hereby waive the right to demand a jury trial under any of these actions.

## Upgrades and Revisions

Free flash upgrades may be obtained on any revisions pertaining to present controller firmware operation, including but not limited to bug fixes and compatibility modifications, for a period of six months from the original date of purchase. Contact the EMC Test Systems, L.P. EMCO Sales Department for information on available upgrades. Upgrades may be obtained after the deadline for a nominal handling fee, or downloaded from the ETS web site at <http://www.emctest.com>. Possible future upgrades which add to the functional capabilities of the present controller may also be obtained for a nominal upgrade fee.

*See also:* Limited Warranty

## Copyright Notice

This manual, the associated controller firmware, and any included software or printed material are all copyright 1996-2001, by EMC Test Systems, L.P., and are protected by national and international copyright laws. They may not be reproduced in whole or in part in any form without the express written consent of EMC Test Systems, L.P. Additional copyright stipulations are as follows:

- The 1050/51/53 command set is copyright 1982, 1988, 1990, The Electro-Mechanics Company.
- The 1060 GPIB command set is copyright 1982, 1988, 1990, The Electro-Mechanics Company.
- The 1090 GPIB command set is copyright 1990, 1991, The Electro-Mechanics Company.
- The 2090 GPIB command set is copyright 1995, The Electro-Mechanics Company, and copyright 1996-2001, EMC Test Systems, L.P.
- The 2190 GPIB command set is copyright 1996-2001, EMC Test Systems, L.P.

All of the above command sets are copyright 1996, 1999, 2001, EMC Test Systems, L.P. These command sets may not be used, in whole or in part, in any similar controlling device without the express written consent of EMC Test Systems, L.P. These commands may be included in any software package, commercial or private, only for the purposes of controlling one of the aforementioned EMCO device controllers. This copyright statement supersedes all previous copyright stipulations on the above mentioned products, except where prohibited by law.

The 2090/2190 series interface command sets are copyright 1995-2001 EMC Test Systems, L.P. They may not be reverse engineered or used in any other application without the express written consent of EMC Test Systems, L.P. Additional copyright stipulations are as follows:

- The 2090 fiber optic interface command set is copyright 1995, The Electro-Mechanics Company, and copyright 1996-2001, EMC Test Systems, L.P.
- The 2190 fiber optic interface command set is copyright 1996-2001, EMC Test Systems, L.P.

This copyright statement supersedes all previous copyright stipulations on the above mentioned products, except where prohibited by law.

# TECHNICAL SUPPORT

---

---

When contacting ETS-Lindgren for technical assistance, please have the following information available to help us expedite your call. You may fax it to the attention of Model 2090 Technical Support at +1.512.531.6400, or e-mail it to support@emctest.com. You may also contact the ETS-Lindgren Customer Service department for assistance by calling +1.512.531.6400.

Name: \_\_\_\_\_

Company: \_\_\_\_\_

Phone: \_\_\_\_\_

Fax: \_\_\_\_\_

ETS-Lindgren Model Number: \_\_\_\_\_

Firmware Revision: \_\_\_\_\_

Purchase Date: \_\_\_\_\_

Attached Device Type(s): \_\_\_\_\_

GPIB Interface: \_\_\_\_\_

Symptoms: \_\_\_\_\_

\_\_\_\_\_

\_\_\_\_\_

\_\_\_\_\_

\_\_\_\_\_

\_\_\_\_\_

\_\_\_\_\_

\_\_\_\_\_

\_\_\_\_\_

\_\_\_\_\_

\_\_\_\_\_

\_\_\_\_\_

\_\_\_\_\_

\_\_\_\_\_

\_\_\_\_\_

\_\_\_\_\_

\_\_\_\_\_

\_\_\_\_\_

\_\_\_\_\_

\_\_\_\_\_

\_\_\_\_\_

This page intentionally left blank.

# EUROPEAN COMMUNITY DECLARATION OF CONFORMITY

---

---

The EC Declaration of Conformity is the method by which EMC Test Systems, L.P. declares that the equipment listed on this document complies with the EMC and Low-voltage Directives.

**Factory:**

EMC Test Systems, L.P.  
P.O. Box 80589  
Austin, Texas USA  
78708-0589

**Issued by:**

EMC Test Systems, L.P.  
P.O. Box 80589  
Austin, Texas USA  
78708-0589

The products manufactured under the EMCO product name and listed below are eligible to bear the EC Mark:

Model 2090 Multi-Device Controller

**Applicable Requirements:**

Standard

EN61010-1

EN55022

IEC 801-2

IEC 801-3

IEC 801-4

EN61010-1

Criteria

Safety requirements for electrical equipment for measurement, control and laboratory use

Class B

Level 2 4/8kV

Level 2 3V/m

Level 2 .5 I/O, 1kV AC

Safety requirements for electrical equipment for measurement, control, and laboratory use.

**Authorized Signatories**



Bruce Butler, Vice President /General Manager

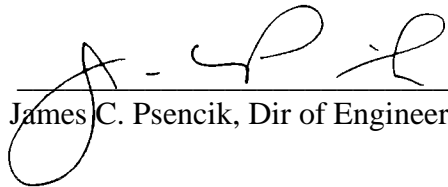

James C. Psencik, Dir of Engineering



Charles Garrison, Quality Assurance

**Date of Declaration: April 10, 1997**

The authorizing signature on the EC Declaration of Conformity document authorizes EMC Test Systems, L.P. to affix the CE mark to the indicated product. CE marks placed on these products will be distinct and visible. Other marks or inscriptions liable to be confused with the CE mark will not be affixed to these products. EMC Test Systems, L.P. has ensured that appropriate documentation shall remain available on premises for inspection and validation purposes for a period of no less than 10 years.

This page intentionally left blank.



# INDEX

<b>A</b>		Status Reporting .....	84
Air Flotation Turntable.....	71	Typical Flow of Code .....	77
Auxiliary Control Functions.....	68	<b>GPIB Commands</b>	
AUX CONTROL Keys .....	68	*CLS.....	102, 108, 141
<b>B</b>		*ESE.....	102, 108, 141
Back Panel.....	29, 31	*ESE? .....	102, 109, 141
Battery Replacement .....	147	*ESR? .....	102, 109, 142
Bore Sight Tower .....	69	*IDN? .....	102, 109, 142
<b>C</b>		*OPC.....	102, 109, 143
Configuring for Use.....	44	*OPC? .....	102, 109, 143
<b>D</b>		*RST.....	103, 109, 143
Device Connections.....	33, 35	*SRE.....	103, 109, 143, 145
<b>E</b>		*SRE? .....	103, 109
Editing Parameters .....	41	*STB? .....	103, 109, 145
Errors		*TST? .....	103, 109, 146
E001 .....	38, 168, 173	*WAI.....	103, 109, 146
E002 .....	168, 173	AIR .....	102, 103, 111
E003 .....	168, 174	AUX .....	102, 103, 111
E004 .....	168, 175	AUX# .....	102, 103, 111
E005 .....	169, 176	AUX#?.....	102, 103, 112
E006 .....	169, 176	CAL.....	102, 103, 112
E007 .....	169, 177	CAL? .....	102, 103, 112
E008 .....	169, 177	CC.....	100, 103, 113
E009 .....	169, 178	CL.....	100, 103, 113
E100 .....	38, 171	CL? .....	100, 104, 114
E101 .....	38, 171	CP.....	100, 104, 114, 115
E102 .....	38, 171	CP? .....	100, 104, 115
E103 .....	39, 171	CW.....	100, 101, 104, 115
E104 .....	39, 171	CY .....	101, 104, 116
E996 .....	40, 172	CY?.....	101, 104, 116
E997 .....	40, 172	DIR? .....	104, 117
E998 .....	40, 172	DN .....	100, 101, 104, 117
E999 .....	40, 172	ERE .....	102, 104, 118
Error Code Reference .....	168	ERE?.....	102, 104, 118
<b>F</b>		ERR? .....	102, 104, 119
Flash Upgrading Model 2090.....	157	LD.....	100, 104, 120
Flash Upgrading Motorbases.....	160	LH.....	101, 105, 120
Front Panel .....	20	LH?.....	101, 105, 121
Fuse .....	16, 29, 177	LL .....	100, 101, 105, 121, 122
<b>G</b>		LL? .....	101, 105, 122
<b>GPIB</b>		LV.....	101, 105, 123
Backward Compatibility.....	75	LV?.....	101, 105, 123
Code Sample 1.....	78	N1 .....	102, 105, 123
Code Sample 2.....	79	N2 .....	102, 105, 124
Getting Started.....	76	OFF.....	102, 105, 124
Interconnections .....	36	OFF? .....	102, 105, 124
		P?.....	100, 101, 106, 125
		PH.....	100, 101, 105, 125
		PV.....	100, 101, 105, 125
		RTL .....	101, 106, 125
		S#.....	102, 106, 126
		S? .....	102, 106, 126
		SC .....	101, 106, 126

SC?	106, 127
SEP	102, 106, 127
SEP?	102, 106, 127
SK	101, 102, 106, 128
SKN	102, 106, 129
SKP	102, 106, 129
SKR	102, 107, 130
SS#	102, 107, 130
SS#?	107, 132
SS?	102
ST	100, 101, 107, 132
TG	101, 107, 132
TG?	101, 107, 133
TT	102, 107, 133
TWR	102, 107, 133
TYP?	102, 107, 134
UH	102, 107, 134
UH?	102, 107, 134
UL	100, 101, 107, 136
UL?	101, 108, 137
UP	100, 101, 108, 137
UV	102, 108, 137
UV?	102, 108, 138
VS?	108, 138
WL	100, 101, 108, 138, 139
WL?	101, 108, 139
ZERO	108, 139
ZERO?	108, 140
<b>I</b>	
Installing Flash ROMs	151
<b>L</b>	
Limit Functions	60
CURRENT POSITION Key	60
DECRM Key	60
DOWN/CCW Key	60
ENTER Key	60
INCRM Key	60
UP/CW Key	60
Local Functions	
Local Key	57
<b>M</b>	
Maintenance	147
Manual Operations	56
Multi-Axis Positioner	72
<b>P</b>	
Parameter List	
b1	48
BASE	53
C	48
OC On/OFF	52
OSCLr	52
P1	46
P2	46
P3	46
P4	47
P5	47
P8	48
P9	48
PCLr	51
S0	50
S1-S8	51
ZERO	53, 54
Polarization	
Limits Violation E006	63, 65
Polarization Key	63
Position Functions	57
DOWN/CCW Key	58
STOP Key	60
UP/CW Key	57
Power Requirements	32
<b>R</b>	
Rack Mounting	33
Remote Operations	73
LOCAL Key	73
Reverberation Paddle	71
<b>S</b>	
Scan Function	61
SCAN Key	61
Software	
Copyright Notice	186
Upgrades and Revisions	185
Speeds	
Changing	66
SPEED Key	66
Standard Configuration	
Electrical	16
Physical	16
Startup	37
Step Functions	62
DEC Key	62
INC Key	62
<b>U</b>	
Unpacking the Controller	19
<b>W</b>	
Warranty	
EMCO Products	181