

Operating Manual

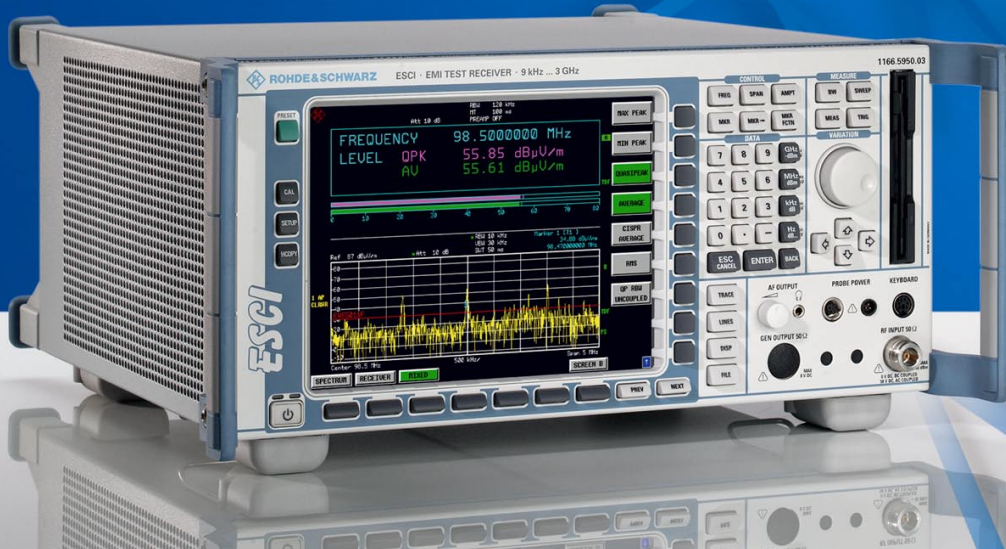

EMI Test Receiver

R&S® ESCI
1166.5950.03

This manual consists of 2 volumes:

Volume 2

Printed in the Federal
Republic of Germany



Dear Customer,

R&S® is a registered trademark of Rohde & Schwarz GmbH & Co. KG
Trade names are trademarks of the owners.

Tabbed Divider Overview

Volume 1 - Operating Manual - Manual Control

Data Sheet

Safety Instructions
Certificate of Quality
EU Certificate of Conformity
Support Center Address
List of R&S Representatives

Manuals for Test Receiver R&S ESCI

Tabbed Divider

1	Chapter 1:	Putting into Operation
2	Chapter 2:	Getting Started
3	Chapter 3:	Operation
4	Chapter 4:	Functional Description
5		Index

Volume 2 - Operating Manual - Remote Control

Safety Instructions

Tabbed Divider









5	Chapter 5:	Remote Control – Basics
6	Chapter 6:	Remote Control – Commands
7	Chapter 7:	Remote Control – Program Examples
8	Chapter 8:	Maintenance and Hardware Interfaces
9	Chapter 9:	Error Messages
10		Index

Safety Instructions

This unit has been designed and tested in accordance with the EC Certificate of Conformity and has left the manufacturer's plant in a condition fully complying with safety standards.

To maintain this condition and to ensure safe operation, the user must observe all instructions and warnings given in this operating manual.

Safety-related symbols used on equipment and documentation from R&S:

							
Observe operating instructions	Weight indication for units >18 kg	PE terminal	Ground terminal	Danger! Shock hazard	Warning! Hot surfaces	Ground	Attention! Electrostatic sensitive devices require special care

- The unit may be used only in the operating conditions and positions specified by the manufacturer. Unless otherwise agreed, the following applies to R&S products:
IP degree of protection 2X, pollution severity 2 overvoltage category 2, only for indoor use, altitude max. 2000 m.
The unit may be operated only from supply networks fused with max. 16 A.
Unless specified otherwise in the data sheet, a tolerance of $\pm 10\%$ shall apply to the nominal voltage and of $\pm 5\%$ to the nominal frequency.
- For measurements in circuits with voltages $V_{\text{rms}} > 30 \text{ V}$, suitable measures should be taken to avoid any hazards.
(using, for example, appropriate measuring equipment, fusing, current limiting, electrical separation, insulation).
- If the unit is to be permanently wired, the PE terminal of the unit must first be connected to the PE conductor on site before any other connections are made. Installation and cabling of the unit to be performed only by qualified technical personnel.
- For permanently installed units without built-in fuses, circuit breakers or similar protective devices, the supply circuit must be fused such as to provide suitable protection for the users and equipment.
- Prior to switching on the unit, it must be ensured that the nominal voltage set on the unit matches the nominal voltage of the AC supply network.
If a different voltage is to be set, the power fuse of the unit may have to be changed accordingly.
- Units of protection class I with disconnectible AC supply cable and appliance connector may be operated only from a power socket with earthing contact and with the PE conductor connected.
- It is not permissible to interrupt the PE conductor intentionally, neither in the incoming cable nor on the unit itself as this may cause the unit to become electrically hazardous.
Any extension lines or multiple socket outlets used must be checked for compliance with relevant safety standards at regular intervals.
- If the unit has no power switch for disconnection from the AC supply, the plug of the connecting cable is regarded as the disconnecting device. In such cases it must be ensured that the power plug is easily reachable and accessible at all times (length of connecting cable approx. 2 m). Functional or electronic switches are not suitable for providing disconnection from the AC supply.
If units without power switches are integrated in racks or systems, a disconnecting device must be provided at system level.
- Applicable local or national safety regulations and rules for the prevention of accidents must be observed in all work performed.
Prior to performing any work on the unit or opening the unit, the latter must be disconnected from the supply network.
Any adjustments, replacements of parts, maintenance or repair may be carried out only by authorized R&S technical personnel.

continued overleaf

Safety Instructions

Only original parts may be used for replacing parts relevant to safety (eg power switches, power transformers, fuses). A safety test must be performed after each replacement of parts relevant to safety.

(visual inspection, PE conductor test, insulation-resistance, leakage-current measurement, functional test).

10. Ensure that the connections with information technology equipment comply with IEC950 / EN60950.
11. Lithium batteries must not be exposed to high temperatures or fire.
Keep batteries away from children.
If the battery is replaced improperly, there is danger of explosion. Only replace the battery by R&S type (see spare part list).
Lithium batteries are suitable for environmentally-friendly disposal or specialized recycling. Dispose them into appropriate containers, only.
Do not short-circuit the battery.

12. Equipment returned or sent in for repair must be packed in the original packing or in packing with electrostatic and mechanical protection.
13. Electrostatics via the connectors may damage the equipment. For the safe handling and operation of the equipment, appropriate measures against electrostatics should be implemented.
14. The outside of the instrument is suitably cleaned using a soft, lint-free dustcloth. Never use solvents such as thinners, acetone and similar things, as they may damage the front panel labeling or plastic parts.
15. Any additional safety instructions given in this manual are also to be observed.

Contents - Chapter 5 "Remote Control - "Basics"

5 Remote Control - Basics.....	5.1
Introduction.....	5.1
Getting Started.....	5.2
Starting Remote Control Operation.....	5.3
Display Contents during Remote Control	5.3
Remote Control via IEC/IEEE Bus	5.4
Setting the Device Address.....	5.4
Return to Manual Operation.....	5.4
Remote Control via RS-232-Interface	5.5
Setting the Transmission Parameters.....	5.5
Return to Manual Operation.....	5.5
Limitations	5.5
Remote Control in a Network (RSIB Interface)	5.6
Setting the Device Address.....	5.6
Return to Manual Operation.....	5.6
Messages	5.7
IEC/IEEE-Bus Interface Messages	5.7
Device Messages (Commands and Device Responses).....	5.7
Structure and Syntax of the Device Messages.....	5.8
SCPI Introduction	5.8
Structure of a Command.....	5.8
Structure of a Command Line	5.11
Responses to Queries.....	5.12
Parameters.....	5.13
Overview of Syntax Elements	5.14
Instrument Model and Command Processing.....	5.15
Input Unit.....	5.15
Command Recognition.....	5.16
Instrument Data Base and Instrument Hardware.....	5.16
Output Unit	5.17
Command Sequence and Command Synchronization	5.17
Status Reporting System.....	5.18
Structure of an SCPI Status Register.....	5.18
Overview of the Status Registers.....	5.20
Description of the Status Registers.....	5.21
Status Byte (STB) and Service Request Enable Register (SRE).....	5.21
IST Flag and Parallel Poll Enable Register (PPE)	5.22
Event-Status Register (ESR) and Event-Status-Enable Register (ESE)	5.22
STATus:OPERation Register.....	5.23
STATus:QUEStionable Register	5.24
STATus:QUEStionable:ACPLimit Register	5.25
STATus:QUEStionable:FREQuency Register	5.26
STATus:QUEStionable:LIMit<1 2> Register	5.27
STATus:QUEStionable:LMARgin<1 2> Register	5.28
STATus:QUEStionable:POWEr Register.....	5.29

STATus:QUEStionable:TRANsducer Register	5.30
Application of the Status Reporting Systems	5.31
Service Request, Making Use of the Hierarchy Structure.....	5.31
Serial Poll	5.31
Parallel Poll	5.32
Query by Means of Commands	5.32
Error-Queue Query	5.32
Resetting Values of the Status Reporting System	5.33

5 Remote Control - Basics

In this chapter you'll find:

- instructions on how to put the R&S ESCI into operation via remote control,
- a general introduction to remote control of programmable instruments. This includes the description of the command structure and syntax according to the SCPI standard, the description of command execution and of the status registers,
- diagrams and tables describing the status registers used in the R&S ESCI.

In chapter 6, all remote control functions are described in detail. The subsystems are listed by alphabetical order according to SCPI. All commands and their parameters are listed by alphabetical order in the command list at the end of chapter 6.

Program examples for the R&S ESCI can be found in chapter 7.

The remote control interfaces and their interface functions are described in Chapter 8.

Introduction

The instrument is equipped with an IEC-bus interface according to standard IEC 625.1/IEEE 488.2 and a RS-232 interface. The connectors are located at the rear of the instrument and permit to connect a controller for remote control. In addition, the instrument can be remotely controlled in a local area network (LAN interface) if option B16 is installed.

The instrument supports the SCPI:version 1997.0 (Standard Commands for Programmable Instruments). The SCPI standard is based on standard IEEE 488.2 and aims at the standardization of device-specific commands, error handling and the status registers (see Section "SCPI Introduction").

The tutorial "Automatic Measurement Control – A tutorial on SCPI and IEEE 488.2" from John M. Pieper (R&S order number 0002.3536.00) offers detailed information on concepts and definitions of SCPI. For remote control in a network, information will be found in the relevant section, "Remote Control in a Network (RSIB Interface)".

This section assumes basic knowledge of IEC/IEEE bus programming and operation of the controller. A description of the interface commands can be obtained from the relevant manuals.

The requirements of the SCPI standard placed on command syntax, error handling and configuration of the status registers are explained in detail in the following sections. Tables provide a fast overview of the bit assignment in the status registers. The tables are supplemented by a comprehensive description of the status registers.

The program examples for IEC-bus programming are all written in VISUAL BASIC.

Getting Started

The short and simple operating sequence given below permits fast putting into operation of the instrument and setting of its basic functions. As a prerequisite, the IEC/IEEE-bus address, which is factory-set to 20, must not have been changed.

1. Connect instrument and controller using IEC/IEEE-bus cable.
2. Write and start the following program on the controller:

```
CALL IBFIND("DEV1", receiver%)           'Open port to the instrument
CALL IBPAD(receiver%, 20)                 'Inform controller about instrument address
CALL IBWRT(receiver%, '*RST;*CLS')        'Reset instrument

CALL IBWRT(receiver%, 'FREQ:CENT 100MHz') ' Set center frequency to 100 MHz
CALL IBWRT(receiver%, 'FREQ:SPAN 10MHz')  ' Set span to 10 MHz
CALL IBWRT(receiver%, 'DISP:TRAC:Y:RLEV -10dBm')
                                           ' Set reference level to -10 dBm
```

The instrument now performs a sweep in the frequency range of 95 MHz to 105 MHz in analyzer mode.

3. To return to manual control, press the *LOCAL* key at the front panel

Starting Remote Control Operation

On power-on, the instrument is always in the manual operating state ("LOCAL" state) and can be operated via the front panel.

It is switched to remote control ("REMOTE" state)

IEC/IEEE-bus as soon as it receives an addressed command from a controller.

if it is controlled in a network (RSIB interface), as soon as it receives a command from a controller.

RS-232 as soon as it receives the command "@REM" from a controller.

During remote control, operation via the front panel is disabled. The instrument remains in the remote state until it is reset to the manual state via the front panel or via remote control interfaces. Switching from manual operation to remote control and vice versa does not affect the remaining instrument settings.

Display Contents during Remote Control

During remote control, only the LOCAL softkey appears, with which it is possible to return to manual operation.

In addition, the display of diagrams and results can be blanked out with the command "SYSTem:DISPlay:UPDate OFF" (default in remote control) to obtain optimum performance during remote control operation.

During program execution it is recommended to activate the display of results by means of "SYSTem:DISPlay:UPDate ON" so that it is possible to follow the changes in the device settings and the recorded measurement curves on the screen.

Note: *If the instrument is exclusively operated in remote control, it is recommended to switch on the power-save mode (POWER SAVE). In this mode, the required display is completely switched off after a preset time.*

Remote Control via IEC/IEEE Bus

Setting the Device Address

In order to operate the instrument via the IEC-bus, it must be addressed using the set IEC/IEEE bus address. The IEC/IEEE bus address of the instrument is factory-set to 20. It can be changed manually in the *SETUP - GENERAL SETUP* menu or via IEC bus. Addresses 0 to 30 are permissible.

Manually:

- Call *SETUP - GENERAL SETUP* menu
- Enter desired address in table *GPIB-ADDRESS*
- Terminate input using the *ENTER* key

Via IEC/IEEE bus:

CALL IBFIND("DEV1", receiver%)	'Open port to the instrument
CALL IBPAD(receiver%, 20)	'Inform controller about old address
CALL IBWRT(receiver%, "SYST:COMM:GPIB:ADDR 18")	'Set instrument to new address
CALL IBPAD(receiver%, 18)	'Inform controller about new address

Return to Manual Operation

Return to manual operation is possible via the front panel or the IEC/IEEE bus.

Manually:

- Press the *LOCAL* softkey or the *PRESET* key

- Notes:**
- Before the transition, command processing must be completed as otherwise transition to remote control is performed immediately.
 - The keys can be disabled by the universal command *LLO* (see Chapter 8, *IEC/IEEE-Bus Interface – Interface Messages*) in order to prevent unintentional transition. In this case, transition to manual mode is only possible via the IEC/IEEE bus.
 - The keys can be enabled again by deactivating the *REN* line of the IEC/IEEE bus (see Chapter 8, *IEC/IEEE-Bus Interface – Bus Lines*).

Via IEC bus:

...	
CALL IBLOC(receiver%)	'Set instrument to manual operation
...	

Remote Control via RS-232-Interface

Setting the Transmission Parameters

To enable an error-free and correct data transmission, the parameters of the unit and the controller should have the same setting.

Parameters can be manually changed in menu *SETUP-GENERAL SETUP* in table *COM PORT* or via remote control using the command `SYSTEM:COMMunicate:SERial:...`

The transmission parameters of the COM interface are factory-set to the following values:

baudrate = 9600, data bits = 8, stop bits = 1, parity = NONE and owner = INSTRUMENT.

For remote control operation, the interface should be allocated to the operating system (owner = OS) so that the control characters including @ can be recognized by the interface.

Manually:

Setting the COM interface

- Call *SETUP-GENERAL SETUP* menu
- Select desired baudrate, bits, stopbit, parity in table *COM PORT*.
- Set owner to OS in table *COM PORT*.
- Terminate input using the *ENTER* key.

Return to Manual Operation

Return to manual operation is possible via the front panel or via RS-232 interface.

Manually:

- Press the *LOCAL* softkey or the *PRESET* key.

Notes:

- Before the transition, command processing must be completed as otherwise transition to remote control is performed immediately
- The keys can be enabled again by sending the control string "@LOC" via RS-232 (see Chapter 8, S-232-C Interface - Control Commands).

Via RS-232:

```
...
v24puts(port, "@LOC");    Set instrument to manual operation..
...
```

Limitations

The following limitations apply if the unit is remote-controlled via the RS-232-C interface:

- No interface messages, only control strings (see interface description in Chapter 8, *RS-232-C Interface – Control Commands*).
- Only the Common Commands *OPC? can be used for command synchronization, *WAI and *OPC are not available.
- Block data cannot be transmitted.

Remote Control in a Network (RSIB Interface)

Setting the Device Address

For control of the instrument in a network, it must be accessed using the preselected IP address. The IP address of the instrument (device address) is defined in the network configuration.

Setting the IP address:

- Call *SETUP - GENERAL SETUP* – CONFIGURE NETWORK menu.
- Select "Protocols" tab.
- Set IP address for TCP/IP protocol under "Properties" (see section on option FSP-B16).

Return to Manual Operation

Return to manual operation can be made manually via the front panel or remotely via the RSIB interface.

Manually: ➤ Press *LOCAL* softkey or *PRESET* key.

Note:

- *Make sure that the execution of commands is completed prior to switchover since otherwise the instrument will switch back to remote control immediately.*

Via RSIB interface:

```
...  
CALL RSDLLibloc(receiver%, ibsta%, iberr%, ibcntl&)'Set  
device to manual control  
...
```

Messages

The messages transferred via the data lines of the IEC bus (see Chapter 8, IEC/IEEE-Bus Interface) can be divided into two groups:

- **interface messages and**
- **device messages.**

IEC/IEEE-Bus Interface Messages

Interface messages are transferred on the data lines of the IEC bus, the "ATN" control line being active. They are used for communication between controller and instrument and can only be sent by a controller which has the IEC/IEEE bus control. Interface commands can be subdivided into

- **universal commands and**
- **addressed commands.**

Universal commands act on all devices connected to the IEC/IEEE bus without previous addressing, addressed commands only act on devices previously addressed as listeners. The interface messages relevant to the instrument are listed in Chapter 8, IEC/IEEE-Bus Interface – Interface Functions.

Device Messages (Commands and Device Responses)

Device messages are transferred on the data lines of the IEC bus, the "ATN" control line not being active. ASCII code is used.

A distinction is made according to the direction in which they are sent on the IEC/IEEE bus:

- **Commands** are messages the controller sends to the instrument. They operate the device functions and request informations.
The commands are subdivided according to two criteria::
 1. According to the effect they have on the instrument:
 - Setting commands** cause instrument settings such as reset of the instrument or setting the center frequency.
 - Queries** cause data to be provided for output on the IEC/IEEE bus, e.g. for identification of the device or polling the marker.
 2. According to their definition in standard IEEE 488.2:
 - Common Commands** are exactly defined as to their function and notation in standard IEEE 488.2. They refer to functions such as management of the standardized status registers, reset and selftest.
 - Device-specific commands** refer to functions depending on the features of the instrument such as frequency setting. A majority of these commands has also been standardized by the SCPI committee (cf. Section "SCPI Introduction").
- **Device responses** are messages the instrument sends to the controller after a query. They can contain measurement results, instrument settings and information on the instrument status (cf. Section "Responses to Queries").

Structure and syntax of the device messages are described in the following Section.

Structure and Syntax of the Device Messages

SCPI Introduction

SCPI (Standard Commands for Programmable Instruments) describes a standard command set for programming instruments, irrespective of the type of instrument or manufacturer. The goal of the SCPI consortium is to standardize the device-specific commands to a large extent. For this purpose, a model was developed which defines the same functions inside a device or for different devices. Command systems were generated which are assigned to these functions. Thus it is possible to address the same functions with identical commands. The command systems are of a hierarchical structure.

Fig. 5-1 illustrates this tree structure using a section of command system SENSE, which controls the device-specific settings, that do not refer to the signal characteristics of the measurement signal.

SCPI is based on standard IEEE 488.2, i.e. it uses the same syntactic basic elements as well as the common commands defined in this standard. Part of the syntax of the device responses is defined with greater restrictions than in standard IEEE 488.2 (see Section "Responses to Queries").

Structure of a Command

The commands consist of a so-called header and, in most cases, one or more parameters. Header and parameter are separated by a "white space" (ASCII code 0 to 9, 11 to 32 decimal, e.g. blank). The headers may consist of several key words. Queries are formed by directly appending a question mark to the header.

Note: *The commands used in the following examples are not in every case implemented in the instrument.*

Common commands

Common commands consist of a header preceded by an asterisk "*" and one or several parameters, if any.

Examples:

*RST	RESET, resets the device
*ESE 253	EVENT STATUS ENABLE, sets the bits of the event status enable register
*ESR?	EVENT STATUS QUERY, queries the contents of the event status register.

Device-specific commands

Hierarchy: Device-specific commands are of hierarchical structure (see Fig. 5-1). The different levels are represented by combined headers. Headers of the highest level (root level) have only one key word. This key word denotes a complete command system.

Example: `SENSe` This key word denotes the command system `SENSe`.

For commands of lower levels, the complete path has to be specified, starting on the left with the highest level, the individual key words being separated by a colon ":".

Example: `SENSe:FREQuency:SPAN 10MHZ`

This command lies in the third level of the `SENSe` system. It set the frequency span.

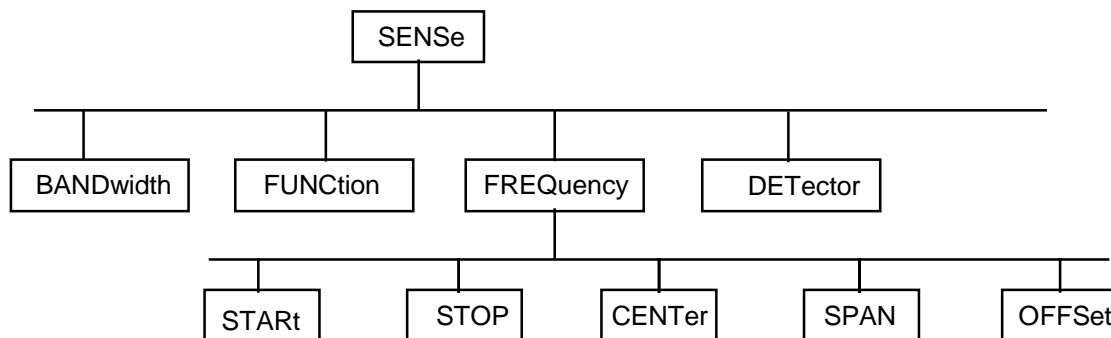

Fig. 5-1 Tree structure the SCPI command systems using the `SENSe` system by way of example

Some key words occur in several levels within one command system. Their effect depends on the structure of the command, that is to say, at which position in the header of a command they are inserted.

Example: `SOURce:FM:POLarity NORMal`

This command contains key word `POLarity` in the third command level. It defines the polarity between modulator and modulation signal.

`SOURce:FM:EXTernal:POLarity NORMal`

This command contains key word `POLarity` in the fourth command level. It defines the polarity between modulation voltage and the resulting direction of the modulation only for the external signal source indicated.

Optional key words: Some command systems permit certain key words to be optionally inserted into the header or omitted. These key words are marked by square brackets in the description. The full command length must be recognized by the instrument for reasons of compatibility with the SCPI standard. Some commands are considerably shortened by these optional key words.

Example: [SENSe]:BANDwidth[:RESolution]:AUTO

This command couples the resolution bandwidth of the instrument to other parameters. The following command has the same effect:

BANDwidth:AUTO

Note: *An optional key word must not be omitted if its effect is specified in detail by a numeric suffix.*

Long and short form: The key words feature a long form and a short form. Either the short form or the long form can be entered, other abbreviations are not permissible.

Beispiel: STATus:QUESTionable:ENABle 1= STAT:QUES:ENAB 1

Note: *The short form is marked by upper-case letters, the long form corresponds to the complete word. Upper-case and lower-case notation only serve the above purpose, the instrument itself does not make any difference between upper-case and lower-case letters.*

Parameter: The parameter must be separated from the header by a "white space". If several parameters are specified in a command, they are separated by a comma ",". A few queries permit the parameters MINimum, MAXimum and DEFault to be entered. For a description of the types of parameter, refer to Section "Parameters".

Example: SENSe:FREQuency:STOP? MAXimum Response: 3.5E9
This query requests the maximal value for the stop frequency.

Numeric suffix: If a device features several functions or features of the same kind, e.g. inputs, the desired function can be selected by a suffix added to the command. Entries without suffix are interpreted like entries with the suffix 1.

Example:. SYSTem:COMMunicate:SERial2:BAUD 9600

This command sets the baudrate of a second serial interface.

Structure of a Command Line

A command line may consist of one or several commands. It is terminated by a <New Line>, a <New Line> with EOI or an EOI together with the last data byte. The IEC/IEEE driver of the controller usually produces automatically an EOI together with the last data byte.

Several commands in a command line are separated by a semicolon ";". If the next command belongs to a different command system, the semicolon is followed by a colon.

Example:

```
CALL IBWRT(receiver%, "SENSe:FREQuency:CENTer 100MHz;:INPut:ATTenuation 10")
```

This command line contains two commands. The first one is part of the SENSe command system and is used to determine the center frequency of the instrument. The second one is part of the INPut command system and sets the input signal attenuation.

If the successive commands belong to the same system, having one or several levels in common, the command line can be abbreviated. For that purpose, the second command after the semicolon starts with the level that lies below the common levels (see also Fig. 5-1). The colon following the semicolon must be omitted in this case.

Example:

```
CALL IBWRT(receiver%, "SENSe:FREQuency:START 1E6;:SENSe:FREQuency:STOP 1E9")
```

This command line is represented in its full length and contains two commands separated from each other by the semicolon. Both commands are part of the SENSe command system, subsystem FREQuency, i.e. they have two common levels.

When abbreviating the command line, the second command begins with the level below SENSe:FREQuency. The colon after the semicolon is omitted.

The abbreviated form of the command line reads as follows:

```
CALL IBWRT(receiver%, "SENSe:FREQuency:START 1E6;STOP 1E9")
```

However, a new command line always begins with the complete path.

```
Example: CALL IBWRT(receiver, "SENSe:FREQuency:START 1E6")
        CALL IBWRT(receiver%, "SENSe:FREQuency:STOP 1E9")
```

Responses to Queries

A query is defined for each setting command unless explicitly specified otherwise. It is formed by adding a question mark to the associated setting command. According to SCPI, the responses to queries are partly subject to stricter rules than in standard IEEE 488.2.

1. The requested parameter is transmitted without header.

Example: `INPut:COUPling?`

Response: `DC`

2. Maximum values, minimum values and all further quantities, which are requested via a special text parameter are returned as numerical values.

Example: `SENSe:FREQuency:STOP? MAX`

Response: `3.5E9`

3. Numerical values are output without a unit. Physical quantities are referred to the basic units or to the units set using the `Unit` command.

Example: `SENSe:FREQuency:CENTer?`

Response: `1E6` for 1 MHz

4. Truth values <Boolean values> are returned as 0 (for OFF) and 1 (for ON).

Example: `SENSe:BANDwidth:AUTO?`

Response: `1` for ON

5. Text (character data) is returned in a short form (see also Section 3.5.5).

Example: `SYSTem:COMMunicate:SERial:CONTrol:RTS?` Response(for standard): `STAN`

Parameters

Most commands require a parameter to be specified. The parameters must be separated from the header by a "white space". Permissible parameters are numerical values, Boolean parameters, text, character strings and block data. The type of parameter required for the respective command and the permissible range of values are specified in the command description

Numerical values Numerical values can be entered in any form, i.e. with sign, decimal point and exponent. Values exceeding the resolution of the instrument are rounded up or down. The mantissa may comprise up to 255 characters, the exponent must lie inside the value range -32000 to 32000. The exponent is introduced by an "E" or "e". Entry of the exponent alone is not permissible. In the case of physical quantities, the unit can be entered. Permissible unit prefixes are G (giga), MA (mega), MOHM and MHZ are also permissible), K (kilo), M (milli), U (micro) and N (nano). If the unit is missing, the basic unit is used.

Example:

SENSe:FREQuency:STOP 1.5GHz = SENSe:FREQuency:STOP 1.5E9

Special numerical The texts MINimum, MAXimum, DEFault, UP and DOWN are interpreted as values special numerical values.

In the case of a query, the numerical value is provided.

Example: Setting command: SENSe:FREQuency:STOP MAXimum

Query: SENSe:FREQuency:STOP? Response: 3.5E9

MIN/MAX MINimum and MAXimum denote the minimum and maximum value.

DEF DEFault denotes a preset value which has been stored in the EPROM. This value conforms to the default setting, as it is called by the *RST command

UP/DOWN UP, DOWN increases or reduces the numerical value by one step. The step width can be specified via an allocated step command (see annex C, List of Commands) for each parameter which can be set via UP, DOWN.

INF/NINF INFINITY, Negative INFINITY (NINF) Negative INFINITY (NINF) represent the numerical values -9.9E37 or 9.9E37, respectively. INF and NINF are only sent as device responses.

NAN Not A Number (NAN) represents the value 9.91E37. NAN is only sent as device response. This value is not defined. Possible causes are the division of zero by zero, the subtraction of infinite from infinite and the representation of missing values.

Boolean Parameters Boolean parameters represent two states. The ON state (logically true) is represented by ON or a numerical value unequal to 0. The OFF state (logically untrue) is represented by OFF or the numerical value 0. 0 or 1 is provided in a query.

Example: Setting command: DISPlay:WINDow:STATe ON

Query: DISPlay:WINDow:STATe? Response: 1

Text Text parameters observe the syntactic rules for key words, i.e. they can be entered using a short or long form. Like any parameter, they have to be separated from the header by a white space. In the case of a query, the short form of the text is provided.

Example: Setting command: `INPut:COUPling GROund`
 Query: `INPut:COUPling?` Response `GRO`

Strings Strings must always be entered in quotation marks (' or ").

Example: `SYSTem:LANGUage "SCPI"` or
`SYSTem:LANGUage 'SCPI'`

Block data Block data are a transmission format which is suitable for the transmission of large amounts of data. A command using a block data parameter has the following structure:

Example: `HEADer:HEADer #45168xxxxxxxx`

ASCII character # introduces the data block. The next number indicates how many of the following digits describe the length of the data block. In the example the 4 following digits indicate the length to be 5168 bytes. The data bytes follow. During the transmission of these data bytes all End or other control signs are ignored until all bytes are transmitted.

Overview of Syntax Elements

The following survey offers an overview of the syntax elements.

- :** The colon separates the key words of a command. In a command line the colon after the separating semicolon marks the uppermost command level.
- ;** The semicolon separates two commands of a command line. It does not alter the path.
- ,** The comma separates several parameters of a command.
- ?** The question mark forms a query.
- *** The asterix marks a common command.
- "** Quotation marks introduce a string and terminate it.
- #** The double dagger (#) introduces block data
- A "white space (ASCII-Code 0 to 9, 11 to 32 decimal, e.g.blank) separates header and parameter.

Instrument Model and Command Processing

The instrument model shown in Fig. 5-2 has been made viewed from the standpoint of the servicing of IEC-bus commands. The individual components work independently of each other and simultaneously. They communicate by means of so-called "messages".

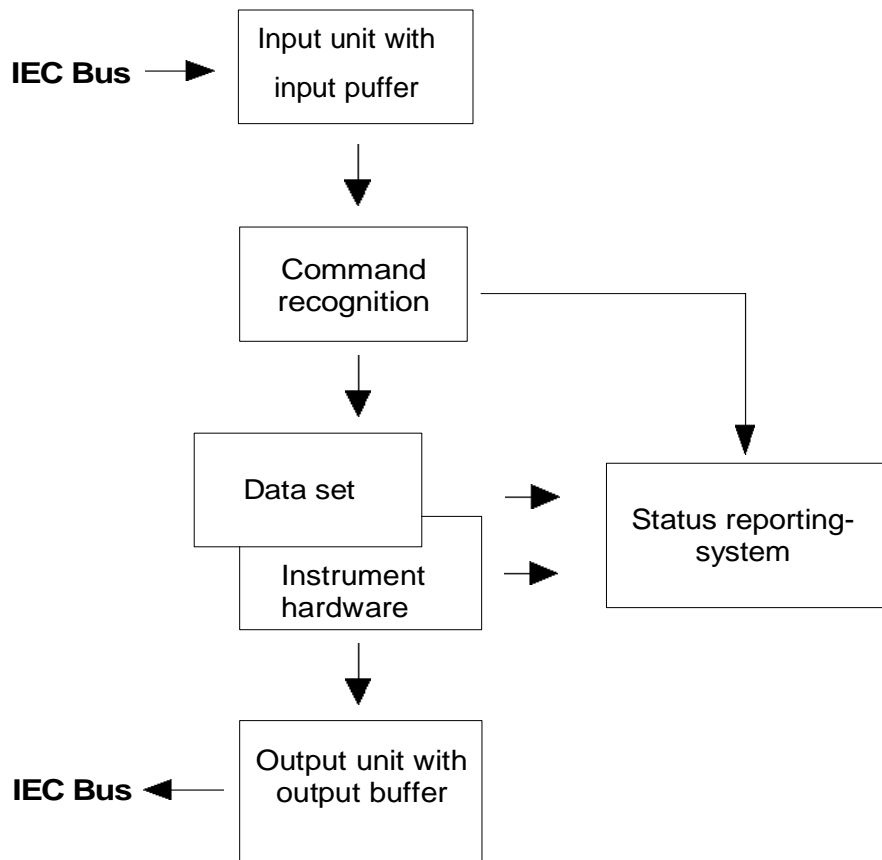

Fig. 5-2 Instrument model in the case of remote control by means of the IEC bus

Input Unit

The input unit receives commands character by character from the IEC bus and collects them in the input buffer. The input unit sends a message to the command recognition as soon as the input buffer is full or as soon as it receives a delimiter, <PROGRAM MESSAGE TERMINATOR>, as defined in IEEE 488.2, or the interface message DCL.

If the input buffer is full, the IEC-bus traffic is stopped and the data received up to then are processed. Subsequently the IEC-bus traffic is continued. If, however, the buffer is not yet full when receiving the delimiter, the input unit can already receive the next command during command recognition and execution. The receipt of a DCL clears the input buffer and immediately initiates a message to the command recognition.

Command Recognition

The command recognition analyses the data received from the input unit. It proceeds in the order in which it receives the data. Only a DCL is serviced with priority, a GET (Group Execute Trigger), e.g., is only executed after the commands received before as well. Each recognized command is immediately transferred to the instrument data base but without being executed there at once.

Syntactical errors in the command are recognized in the command recognition and supplied to the status reporting system. The rest of a command line after a syntax error is analysed further if possible and serviced.

If the command recognition recognizes a delimiter (<PROGRAM MESSAGE SEPARATOR> or <PROGRAM MESSAGE TERMINATOR>) or a DCL, it requests the instrument data base to set the commands in the instrument hardware as well now. Subsequently it is immediately prepared to process commands again. This means for the command servicing that further commands can already be serviced while the hardware is still being set ("overlapping execution").

Instrument Data Base and Instrument Hardware

Here the expression "instrument hardware" denotes the part of the instrument fulfilling the actual instrument function - signal generation, measurement etc. The controller is not included.

The instrument data base is a detailed reproduction of the instrument hardware in the software.

IEC-bus setting commands lead to an alteration in the data set. The data base management enters the new values (e.g. frequency) into the data base, however, only passes them on to the hardware when requested by the command recognition.

The data are only checked for their compatibility among each other and with the instrument hardware immediately before they are transmitted to the instrument hardware. If the detection is made that an execution is not possible, an "execution error" is signalled to the status reporting system. The alteration of the data base are cancelled, the instrument hardware is not reset.

IEC-bus queries induce the data base management to send the desired data to the output unit.

Status Reporting System

The status reporting system collects information on the instrument state and makes it available to the output unit on request. The exact structure and function are described in Section 3.8

Output Unit

The output unit collects the information requested by the controller, which it receives from the data base management. It processes it according to the SCPI rules and makes it available in the output buffer.

If the instrument is addressed as a talker without the output buffer containing data or awaiting data from the data base management, the output unit sends error message "Query UNTERMINATED" to the status reporting system. No data are sent on the IEC bus, the controller waits until it has reached its time limit. This behaviour is specified by SCPI.

Command Sequence and Command Synchronization

What has been said above makes clear that all commands can potentially be carried out overlapping.

In order to prevent an overlapping execution of commands, one of commands *OPC, *OPC? or *WAI must be used. All three commands cause a certain action only to be carried out after the hardware has been set and has settled. By a suitable programming, the controller can be forced to wait for the respective action to occur (cf. Table 5-1).

Table 5-1 Synchronisation using *OPC, *OPC? and *WAI

Command	Action after the hardware has settled	Programming the controller
*OPC	Setting the operation-complete bit in the ESR	- Setting bit 0 in the ESE - Setting bit 5 in the SRE - Waiting for service request (SRQ)
*OPC?	Writing a "1" into the output buffer	Addressing the instrument as a talker
*WAI	Continuing the IEC-bus handshake	Sending the next command

An example as to command synchronization can be found in Chapter "Program Examples".

For a couple of commands the synchronization to the end of command execution is mandatory in order to obtain the desired result. The affected commands require either more than one measurement in order to accomplish the desired instrument setting (eg autorange functions), or they require a longer period of time for execution. If a new command is received during execution of the corresponding function this may either lead to either to an aborted measurement or to invalid measurement data.

The following list includes the commands, for which a synchronization via *OPC, *OPC? or *WAI is mandatory:

Table 5-1 Commands with mandatory synchronization (Overlapping Commands)

Command	Purpose
INIT	start measurement
INIT:CONM	continue measurement
CALC:MARK:FUNC:ZOOM	zoom frequency range around marker 1
CALC:STAT:SCAL:AUTO ONCE	optimize level settings for signal statistic measurement functions
[SENS:]POW:ACH:PRES:RLEV	optimize level settings for adjacent channel power measurements

Status Reporting System

The status reporting system (cf. Fig. 5-4) stores all information on the present operating state of the instrument, e.g. that the instrument presently carries out a calibration and on errors which have occurred. This information is stored in the status registers and in the error queue. The status registers and the error queue can be queried via IEC bus.

The information is of a hierarchical structure. The register status byte (STB) defined in IEEE 488.2 and its associated mask register service request enable (SRE) form the uppermost level. The STB receives its information from the standard event status register (ESR) which is also defined in IEEE 488.2 with the associated mask register standard event status enable (ESE) and registers STATUS:OPERation and STATUS:QUESTionable which are defined by SCPI and contain detailed information on the instrument.

The IST flag ("Individual STATUS") and the parallel poll enable register (PPE) allocated to it are also part of the status reporting system. The IST flag, like the SRQ, combines the entire instrument status in a single bit. The PPE fulfills the same function for the IST flag as the SRE for the service request.

The output buffer contains the messages the instrument returns to the controller. It is not part of the status reporting system but determines the value of the MAV bit in the STB and thus is represented in Fig. 5-4.

Structure of an SCPI Status Register

Each SCPI register consists of 5 parts which each have a width of 16 bits and have different functions (cf. Fig. 5-3). The individual bits are independent of each other, i.e. each hardware status is assigned a bit number which is valid for all five parts. For example, bit 3 of the STATUS:OPERation register is assigned to the hardware status "wait for trigger" in all five parts. Bit 15 (the most significant bit) is set to zero for all parts. Thus the contents of the register parts can be processed by the controller as positive integer.

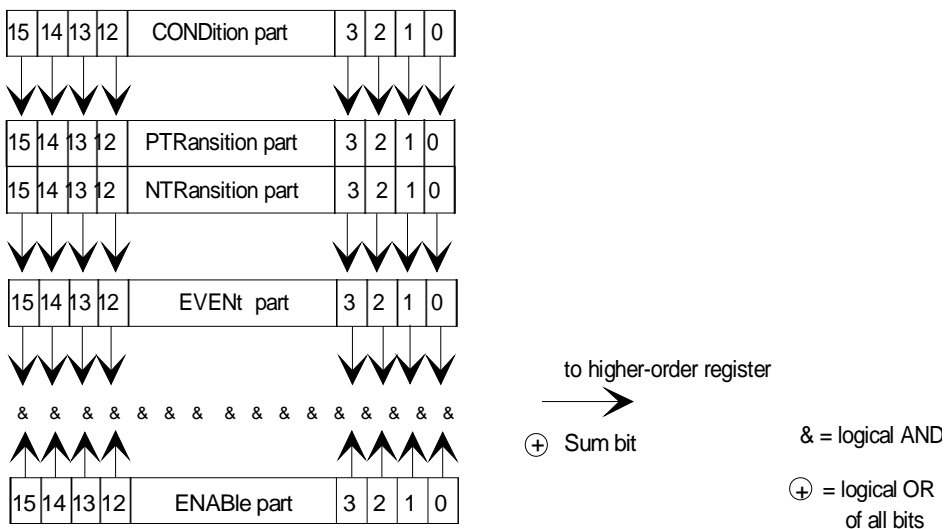

Fig. 5-3 The status-register model

CONDition part	The CONDition part is directly written into by the hardware or the sum bit of the next lower register. Its contents reflects the current instrument status. This register part can only be read, but not written into or cleared. Its contents is not affected by reading.
PTRansition part	The Positive-TRansition part acts as an edge detector. When a bit of the CONDition part is changed from 0 to 1, the associated PTR bit decides whether the EVENT bit is set to 1. PTR bit =1: the EVENT bit is set. PTR bit =0: the EVENT bit is not set. This part can be written into and read at will. Its contents is not affected by reading.
NTRansition part	The Negative-TRansition part also acts as an edge detector. When a bit of the CONDition part is changed from 1 to 0, the associated NTR bit decides whether the EVENT bit is set to 1. NTR-Bit = 1: the EVENT bit is set. NTR-Bit = 0: the EVENT bit is not set. This part can be written into and read at will. Its contents is not affected by reading. With these two edge register parts the user can define which state transition of the condition part (none, 0 to 1, 1 to 0 or both) is stored in the EVENT part.
EVENT part	The EVENT part indicates whether an event has occurred since the last reading, it is the "memory" of the condition part. It only indicates events passed on by the edge filters. It is permanently updated by the instrument. This part can only be read by the user. During reading, its contents is set to zero. In linguistic usage this part is often equated with the entire register.
ENABLE part	The ENABLE part determines whether the associated EVENT bit contributes to the sum bit (cf. below). Each bit of the EVENT part is ANDed with the associated ENABLE bit (symbol '&'). The results of all logical operations of this part are passed on to the sum bit via an OR function (symbol '+'). ENABLE-Bit = 0: the associated EVENT bit does not contribute to the sum bit ENABLE-Bit = 1: if the associated EVENT bit is "1", the sum bit is set to "1" as well. This part can be written into and read by the user at will. Its contents is not affected by reading.
Sum bit	As indicated above, the sum bit is obtained from the EVENT and ENABLE part for each register. The result is then entered into a bit of the CONDition part of the higher-order register. The instrument automatically generates the sum bit for each register. Thus an event, e.g. a PLL that has not locked, can lead to a service request throughout all levels of the hierarchy.
Note:	<i>The service request enable register SRE defined in IEEE 488.2 can be taken as ENABLE part of the STB if the STB is structured according to SCPI. By analogy, the ESE can be taken as the ENABLE part of the ESR.</i>

Overview of the Status Registers

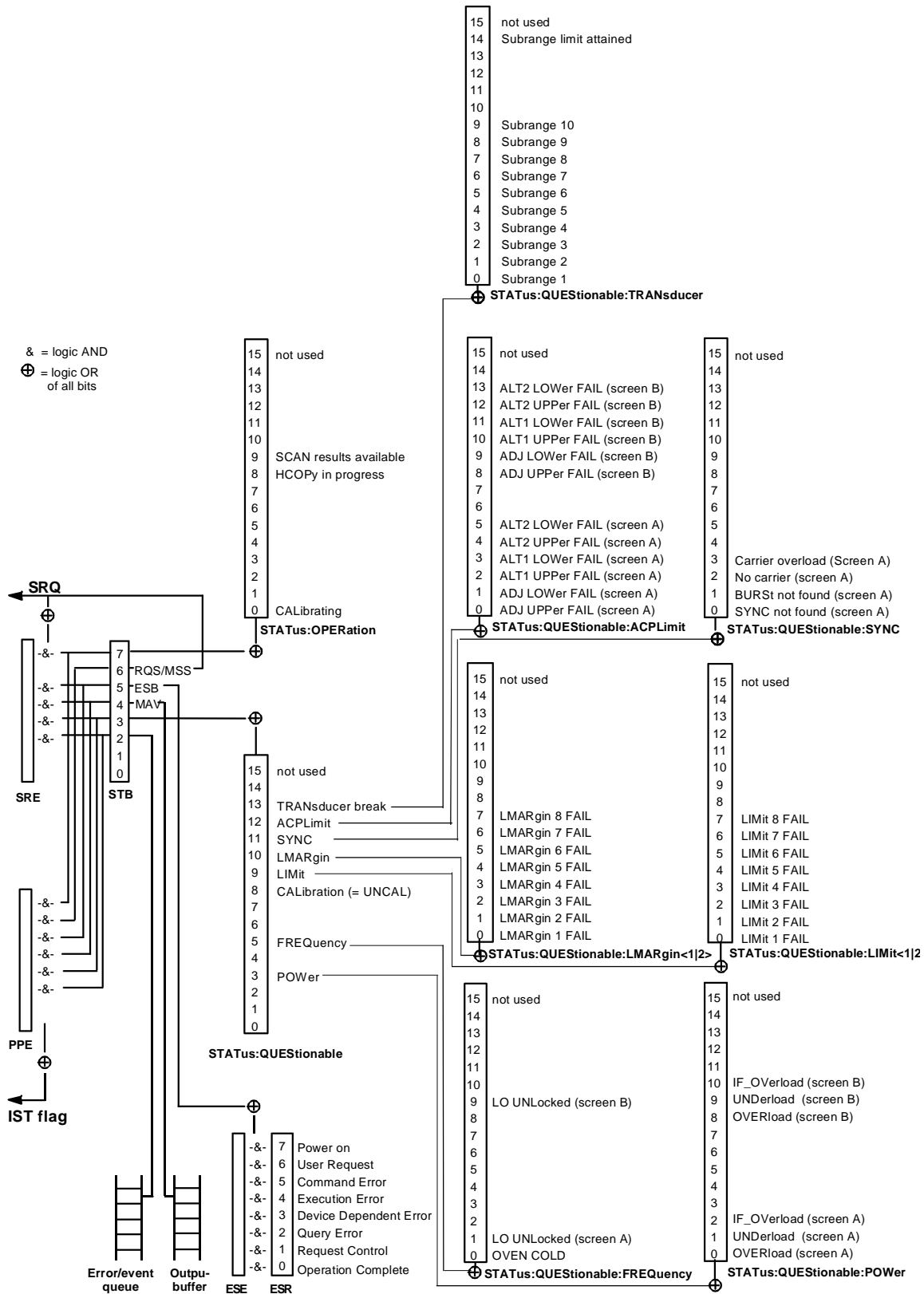

Fig. 5-4 Overview of the status registers

Description of the Status Registers

Status Byte (STB) and Service Request Enable Register (SRE)

The STB is already defined in IEEE 488.2. It provides a rough overview of the instrument status by collecting the pieces of information of the lower registers. It can thus be compared with the CONDition part of an SCPI register and assumes the highest level within the SCPI hierarchy. A special feature is that bit 6 acts as the sum bit of the remaining bits of the status byte.

The STATUS BYTE is read out using the command "***STB?**" or a serial poll.

The STB implies the SRE. It corresponds to the ENABLE part of the SCPI registers as to its function. Each bit of the STB is assigned a bit in the SRE. Bit 6 of the SRE is ignored. If a bit is set in the SRE and the associated bit in the STB changes from 0 to 1, a Service Request (SRQ) is generated on the IEC bus, which triggers an interrupt in the controller if this is appropriately configured and can be further processed there.

The SRE can be set using command "***SRE**" and read using "***SRE?**".

Table 5-2 Meaning of the bits in the status byte

Bit No.	Meaning
2	<p>Error Queue not empty</p> <p>The bit is set when an entry is made in the error queue. If this bit is enabled by the SRE, each entry of the error queue generates a Service Request. Thus an error can be recognized and specified in greater detail by polling the error queue. The poll provides an informative error message. This procedure is to be recommended since it considerably reduces the problems involved with IEC-bus control.</p>
3	<p>QUESTIONable status sum bit</p> <p>The bit is set if an EVENT bit is set in the QUESTIONable: status register and the associated ENABLE bit is set to 1. A set bit indicates a questionable instrument status, which can be specified in greater detail by polling the QUESTIONable status register.</p>
4	<p>MAV bit (message available)</p> <p>The bit is set if a message is available in the output buffer which can be read. This bit can be used to enable data to be automatically read from the instrument to the controller (cf. Chapter 7, program examples).</p>
5	<p>ESB bit</p> <p>Sum bit of the event status register. It is set if one of the bits in the event status register is set and enabled in the event status enable register. Setting of this bit implies an error or an event which can be specified in greater detail by polling the event status register.</p>
6	<p>MSS bit (master status summary bit)</p> <p>The bit is set if the instrument triggers a service request. This is the case if one of the other bits of this registers is set together with its mask bit in the service request enable register SRE.</p>
7	<p>OPERation status register sum bit</p> <p>The bit is set if an EVENT bit is set in the OPERation-Status register and the associated ENABLE bit is set to 1. A set bit indicates that the instrument is just performing an action. The type of action can be determined by polling the OPERation-status register.</p>

IST Flag and Parallel Poll Enable Register (PPE)

By analogy with the SRQ, the IST flag combines the entire status information in a single bit. It can be queried by means of a parallel poll (cf. Section 3.8.4.3) or using command `"*IST?"`.

The parallel poll enable register (PPE) determines which bits of the STB contribute to the IST flag. The bits of the STB are ANDed with the corresponding bits of the PPE, with bit 6 being used as well in contrast to the SRE. The Ist flag results from the ORing of all results. The PPE can be set using commands `"*PRE"` and read using command `"*PRE?"`.

Event-Status Register (ESR) and Event-Status-Enable Register (ESE)

The ESR is already defined in IEEE 488.2. It can be compared with the EVENT part of an SCPI register. The event status register can be read out using command `"*ESR?"`.

The ESE is the associated ENABLE part. It can be set using command `"*ESE"` and read using command `"*ESE?"`.

Table 5-3 Meaning of the bits in the event status register

Bit No.	Meaning
0	Operation Complete This bit is set on receipt of the command <code>*OPC</code> exactly when all previous commands have been executed.
1	This bit is not used
2	Query Error This bit is set if either the controller wants to read data from the instrument without having send a query, or if it does not fetch requested data and sends new instructions to the instrument instead. The cause is often a query which is faulty and hence cannot be executed.
3	Device-dependent Error This bit is set if a device-dependent error occurs. An error message with a number between -300 and -399 or a positive error number, which denotes the error in greater detail, is entered into the error queue (cf. Chapter 9, Error Messages).
4	Execution Error This bit is set if a received command is syntactically correct, however, cannot be performed for other reasons. An error message with a number between -200 and -300, which denotes the error in greater detail, is entered into the error queue (cf. Chapter 9, Error Messages).
5	Command Error This bit is set if a command which is undefined or syntactically incorrect is received. An error message with a number between -100 and -200, which denotes the error in greater detail, is entered into the error queue (cf. Chapter 9 "Error Messages").
6	User Request This bit is set on pressing the <i>LOCAL</i> key.
7	Power On (supply voltage on) This bit is set on switching on the instrument.

STATus:OPERation Register

In the CONDition part, this register contains information on which actions the instrument is being executing or, in the EVENt part, information on which actions the instrument has executed since the last reading. It can be read using commands "STATus:OPERation:CONDition?" or "STATus:OPERation[:EVENT]?".

Table 5-4 Meaning of the bits in the STATus.OPERation register

Bit No.	Meaning
0	CALibrating This bit is set as long as the instrument is performing a calibration.
1 to 7	These bits are not used
8	SCAN results available This bit is set after a scan..
8	HCOPY in progress This bit is set while the instrument is printing a hardcopy.
10 to 14	These bits are not used
15	This bit is always 0

STATus:QUEStionable Register

This register comprises information about indefinite states which may occur if the unit is operated without meeting the specifications. It can be queried by commands `STATus:QUEStionable:CONDition?` and `STATus:QUEStionable[:EVENT]?`.

Table 5-5 Meaning of bits in STATus:QUEStionable register

Bit No.	Meaning
0 to 2	These bits are not used
3	POWER This bit is set if a questionable power occurs (cf. also section "STATus:QUEStionable:POWER Register")
4	TEMPerature This bit is set if a questionable temperature occurs.
5	FREQuency The bit is set if a frequency is questionable (cf. section "STATus:QUEStionable:FREQuency Register")
6 to 7	These bits are not used
8	CALibration The bit is set if a measurement is performed uncalibrated ($\hat{=}$ label "UNCAL")
9	LIMit (device-specific) This bit is set if a limit value is violated (see also section STATus:QUEStionable:LIMit Register)
10	LMARgin (device-specific) This bit is set if a margin is violated (see also section STATus:QUEStionable:LMARgin Register)
11	This bit is not used
12	ACPLimit (device-specific) This bit is set if a limit for the adjacent channel power measurement is violated (see also section "STATus:QUEStionable:ACPLimit Register")
13	TRANsducer break (device-specific) This bit is set if transducer break is reached
14	This bit is not used
15	This bit is always 0.

STATus:QUEStionable:ACPLimit Register

This register comprises information about the observance of limits during adjacent power measurements. It can be queried with commands 'STATus:QUEStionable:ACPLimit:CONDition?' and 'STATus:QUEStionable:ACPLimit[:EVENT]?'

Table 5-6 Meaning of bits in STATus:QUEStionable:ACPLimit register

Bit No.	Meaning
0	ADJ UPPer FAIL(Screen A) This bit is set if in screen A. the limit is exceeded in the upper adjacent channel
1	ADJ LOWer FAIL (Screen A) This bit is set if in screen A the limit is exceeded in the lower adjacent channel.
2	ALT1 UPPer FAIL (Screen A) This bit is set if in screen A the limit is exceeded in the upper 1st alternate channel.
3	ALT1 LOWer FAIL (Screen A) This bit is set if in screen A the limit is exceeded in the lower 1st alternate channel.
4	ALT2 UPPer FAIL (Screen A) This bit is set if in screen A the limit is exceeded in the upper 2nd alternate channel.
5	ALT2 LOWer FAIL (Screen A) This bit is set if in screen A the limit is exceeded in the lower 2nd alternate channel.
6 to 7	not used
8	ADJ UPPer FAIL (Screen B) This bit is set if in screen B the limit is exceeded in the upper adjacent channel.
9	ADJ LOWer FAIL (Screen B) This bit is set if in screen B the limit is exceeded in the lower adjacent channel.
10	ALT1 UPPer FAIL (Screen B) This bit is set if in screen B the limit is exceeded in the upper 1st alternate channel.
11	ALT1 LOWer FAIL (Screen B) This bit is set if in screen B the limit is exceeded in the lower 1st alternate channel.
12	ALT2 UPPer FAIL (Screen B) This bit is set if in screen B the limit is exceeded in the upper 2nd alternate channel.
13	ALT2 LOWer FAIL (Screen B) This bit is set if in screen B the limit is exceeded in the lower 2nd alternate channel.
14	not used
15	This bit is always set to 0.

STATUS:QUESTIONABLE:FREQUENCY Register

This register comprises information about the reference and local oscillator. It can be queried with commands `STATUS:QUESTIONABLE:FREQUENCY:CONDITION?` and `STATUS:QUESTIONABLE:FREQUENCY[:EVENT]?`.

Table 5-7 Meaning of bits in STATUS:QUESTIONABLE:FREQUENCY register

Bit No.	Meaning
0	OVEN COLD This bit is set if the reference oscillator has not yet attained its operating temperature. 'OCXO' will then be displayed.
1	LO UNLocked (Screen A) This bit is set if the local oscillator no longer locks. 'LOUNL' will then be displayed.
2 to 8	not used
9	LO UNLocked (Screen B) This bit is set if the local oscillator no longer locks. 'LOUNL' will then be displayed.
10 to 14	not used
15	This bit is always 0.

STATus:QUEStionable:LIMit<1|2> Register

This register comprises information about the observance of limit lines in the corresponding measurement window (LIMit 1 corresponds to Screen A, LIMit 2 to Screen B). It can be queried with commands `STATus:QUEStionable:LIMit<1|2>:CONDition?` and `STATus:QUEStionable:LIMit<1|2>[:EVENT]?`.

Table 5-8 Meaning of bits in STATus:QUEStionable:LIMit<1|2> register

Bit No.	Meaning
0	LIMit 1 FAIL This bit is set if limit line 1 is violated.
1	LIMit 2 FAIL This bit is set if limit line 2 is violated.
2	LIMit 3 FAIL This bit is set if limit line 3 is violated.
3	LIMit 4 FAIL This bit is set if limit line 4 is violated.
4	LIMit 5 FAIL This bit is set if limit line 5 is violated.
5	LIMit 6 FAIL This bit is set if limit line 6 is violated.
6	LIMit 7 FAIL This bit is set if limit line 7 is violated.
7	LIMit 8 FAIL This bit is set if limit line 8 is violated.
8 to 14	not used
15	This bit is always 0.

STATUS:QUESTIONABLE:LMARGIN<1|2> Register

This register comprises information about the observance of limit margins in the corresponding measurement window (LMARGIN1 corresponds to Screen A, LMARGIN2 corresponds to Screen B). It can be queried with commands STATUS:QUESTIONABLE:LMARGIN<1|2>:CONDITION? and "STATUS :QUESTIONABLE:LMARGIN<1|2>[:EVENT]?".

Table 5-9 Meaning of bits in STATUS:QUESTIONABLE:LMARGIN<1|2> register

Bit No.	Meaning
0	LMARGIN 1 FAIL This bit is set if limit margin 1 is violated.
1	LMARGIN 2 FAIL This bit is set if limit margin 2 is violated.
2	LMARGIN 3 FAIL This bit is set if limit margin 3 is violated.
3	LMARGIN 4 FAIL This bit is set if limit margin 4 is violated.
4	LMARGIN 5 FAIL This bit is set if limit margin 5 is violated.
5	LMARGIN 6 FAIL This bit is set if limit margin 1 is violated.
6	LMARGIN 7 FAIL This bit is set if limit margin 7 is violated.
7	LMARGIN 8 FAIL This bit is set if limit margin 8 is violated.
8 to 14	not used
15	This bit is always 0.

STATus:QUEStionable:POWer Register

This register comprises all information about possible overloads of the unit.

It can be queried with commands `STATus:QUEStionable:POWer:CONDition?` and `"STATus:QUEStionable:POWer[:EVENT]?"`.

Table 5-10 Meaning of bits in STATus:QUEStionable:POWer register

Bit No.	Meaning
0	OVERload (Screen A) This bit is set if the RF input is overloaded. 'OVLD' will then be displayed.
1	UNDerload (Screen A) This bit is set if the RF input is underloaded. 'UNLD' will then be displayed.
2	IF_OVERload (Screen A) This bit is set if the IF path is overloaded. 'IFOVL' will then be displayed.
3 to 7	not used
8	OVERload (Screen B) This bit is set if the RF input is overloaded. 'OVLD' will then be displayed.
9	UNDerload (Screen B) This bit is set if the RF input is underloaded. 'UNLD' will then be displayed.
10	IF_OVERload (Screen B) This bit is set if the IF path is overloaded. 'IFOVL' will then be displayed.
11 to 14	not used
15	This bit is always 0.

STATus QUEStionable:TRANsducer Register

This register indicates that a transducer hold point is attained (bit 15) and what range is to be swept next (bit 0 to 10). The sweep can be continued with command `INITiate2:CONMeasure`.

It can be queried with commands `'STATus:QUEStionable:TRANsducer:CONDition?'` and `'STATus :QUEStionable:TRANsducer[:EVENT]?'`.

Table 5-11 Meaning of bits in STATus:QUEStionable:TRANsducer register

Bit No.	Meaning
0	Range 1 This bit is set when subrange 1 is attained.
1	Range 2 This bit is set when subrange 2 is attained.
2	Range 3 This bit is set when subrange 3 is attained.
3	Range 4 This bit is set when subrange 4 is attained.
4	Range 5 This bit is set when subrange 1 is attained.
5	Range 6 This bit is set when subrange 6 is attained.
6	Range 7 This bit is set when subrange 7 is attained.
7	Range 8 This bit is set when subrange 8 is attained.
8	Range 9 This bit is set when subrange 9 is attained.
9	Range 10 This bit is set when subrange 10 is attained.
10	not used
11	not used
12	not used
13	not used
14	Subrange limit This bit is set when the transducer is at the point of changeover from one range to another.
15	This bit is always 0.

Application of the Status Reporting Systems

In order to be able to effectively use the status reporting system, the information contained there must be transmitted to the controller and further processed there. There are several methods which are represented in the following. Detailed program examples are to be found in chapter 7, Program Examples.

Service Request, Making Use of the Hierarchy Structure

Under certain circumstances, the instrument can send a service request (SRQ) to the controller. Usually this service request initiates an interrupt at the controller, to which the control program can react with corresponding actions. As evident from Fig. 5-4, an SRQ is always initiated if one or several of bits 2, 3, 4, 5 or 7 of the status byte are set and enabled in the SRE. Each of these bits combines the information of a further register, the error queue or the output buffer. The corresponding setting of the ENABLE parts of the status registers can achieve that arbitrary bits in an arbitrary status register initiate an SRQ. In order to make use of the possibilities of the service request, all bits should be set to "1" in enable registers SRE and ESE.

Examples (cf. Fig. 5-4 and chapter 7, Program Examples, as well):

Use of command "*OPC" to generate an SRQ at the end of a sweep.

- CALL IBWRT(analyzer%, "*ESE 1") Set bit 0 in the ESE (Operation Complete)
- CALL IBWRT(analyzer%, "*SRE 32") Set bit 5 in the SRE (ESB)?

After its settings have been completed, the instrument generates an SRQ.

The SRQ is the only possibility for the instrument to become active on its own. Each controller program should set the instrument in a way that a service request is initiated in the case of malfunction. The program should react appropriately to the service request. A detailed example for a service request routine is to be found in chapter 7, Program Examples.

Serial Poll

In a serial poll, just as with command "*STB", the status byte of an instrument is queried. However, the query is realized via interface messages and is thus clearly faster. The serial-poll method has already been defined in IEEE 488.1 and used to be the only standard possibility for different instruments to poll the status byte. The method also works with instruments which do not adhere to SCPI or IEEE 488.2.

The VISUAL BASIC command for executing a serial poll is "IBRSP()". Serial poll is mainly used to obtain a fast overview of the state of several instruments connected to the IEC bus.

Parallel Poll

In a parallel poll, up to eight instruments are simultaneously requested by the controller by means of a single command to transmit 1 bit of information each on the data lines, i.e., to set the data line allocated to each instrument to logically "0" or "1". By analogy to the SRE register which determines under which conditions an SRQ is generated, there is a parallel poll enable register (PPE) which is ANDed with the STB bit by bit as well considering bit 6. The results are ORed, the result is then sent (possibly inverted) as a response in the parallel poll of the controller. The result can also be queried without parallel poll by means of command "*IST".

The instrument first has to be set for the parallel poll using quick-BASIC command "IBPPC()". This command allocates a data line to the instrument and determines whether the response is to be inverted. The parallel poll itself is executed using "IBRPP()".

The parallel-poll method is mainly used in order to quickly find out after an SRQ which instrument has sent the service request if there are many instruments connected to the IEC bus. To this effect, SRE and PPE must be set to the same value. A detailed example as to the parallel poll is to be found in chapter 7, Program Examples.

Query by Means of Commands

Each part of every status register can be read by means of queries. The individual commands are indicated in the detailed description of the registers in Section 3.8.3. What is returned is always a number which represents the bit pattern of the register queried. Evaluating this number is effected by the controller program.

Queries are usually used after an SRQ in order to obtain more detailed information on the cause of the SRQ.

Error-Queue Query

Each error state in the instrument leads to an entry in the error queue. The entries of the error queue are detailed plain-text error messages which can be looked at in the ERROR menu via manual control or queried via the IEC bus using command "SYSTem:ERRor?". Each call of "SYSTem:ERRor?" provides an entry from the error queue. If no error messages are stored there any more, the instrument responds with 0, "No error".

The error queue should be queried after every SRQ in the controller program as the entries describe the cause of an error more precisely than the status registers. Especially in the test phase of a controller program the error queue should be queried regularly since faulty commands from the controller to the instrument are recorded there as well.

Resetting Values of the Status Reporting System

Table 5-12 comprises the different commands and events causing the status reporting system to be reset. None of the commands, except for *RST and SYSTem:PRESet influences the functional instrument settings. In particular, DCL does not change the instrument settings.

Table 5-12 Resetting instrument functions

Event	Switching on supply voltage		DCL,SDC (Device Clear, Selected Device Clear)	*RST or SYSTem:PRESet	STATus:PRESet	*CLS
	Power-On-Status-Clear					
	0	1				
Clear STB,ESR	—	yes	—	—	—	yes
Clear SRE,ESE	—	yes	—	—	—	—
Clear PPE	—	yes	—	—	—	—
Clear EVENTt parts of the registers	—	yes	—	—	—	yes
Clear Enable parts of all OPERation and QUESTionable registers, Fill Enable parts of all other registers with "1".	—	yes	—	—	yes	—
Fill PTRansition parts with "1", Clear NTRansition parts	—	yes	—	—	yes	—
Clear error queue	yes	yes	—	—	—	yes
Clear output buffer	yes	yes	yes	1)	1)	1)
Clear command processing and input buffer	yes	yes	yes	—	—	—

1) Every command being the first in a command line, i.e., immediately following a <PROGRAM MESSAGE TERMINATOR> clears the output buffer.

Contents - Chapter 6

"Remote Control - Description of Commands"

6 Remote Control - Description of Commands.....	6.1
Notation	6.1
Common Commands	6.4
ABORt Subsystem.....	6.8
CALCulate Subsystem	6.8
CALCulate:DELTamarker Subsystem.....	6.9
CALCulate:FEED Subsystem.....	6.17
CALCulate:LIMit Subsystem	6.18
CALCulate:LIMit:ACPower Subsystem	6.22
CALCulate:LIMit:CONTRol Subsystem	6.31
CALCulate:LIMit:LOWer Subsystem.....	6.33
CALCulate:LIMit:UPPer Subsystem.....	6.36
CALCulate:MARKer Subsystem.....	6.39
CALCulate:MARKer:FUNCTion Subsystem.....	6.47
CALCulate:MARKer:FUNCTion:ADEMod Subsystem	6.56
CALCulate:MARKer:FUNCTion:POWer Subsystem	6.59
CALCulate:MARKer:FUNCTion:STRack Subsystem.....	6.64
CALCulate:MARKer:FUNCTion:SUMMary Subsystem.....	6.66
CALCulate:MATH Subsystem	6.76
CALCulate:PEAKsearch PSEarch Subsystem.....	6.78
CALCulate:STATistics Subsystem	6.79
CALCulate:THReshold Subsystem	6.82
CALCulate:UNIT Subsystem.....	6.84
CALibration Subsystem	6.85
DIAGnostic Subsystem	6.87
DISPlay Subsystem	6.91
FORMat Subsystem.....	6.100
HCOPy Subsystem	6.101
INITiate Subsystem	6.106
INPut Subsystem	6.108
INSTRument Subsystem	6.112
MMEMory Subsystem	6.116
OUTPut Subsystem.....	6.126
SENSE Subsystem.....	6.127

[SENSe:]ADEMod - Subsystem	6.127
SENSe:AVERAge Subsystem	6.151
SENSe:BANDwidth Subsystem	6.153
SENSe:CORRection Subsystem.....	6.157
SENSe:DEMod Subsystem	6.163
SENSe:DETEctor Subsystem.....	6.164
SENSe:FMEasurement Subsystem	6.166
SENSe:FREQUency Subsystem	6.168
SENSe:LIST Subsystem	6.171
SENSe:MPOWer Subsystem	6.177
SENSe:POWer Subsystem.....	6.181
SENSe:ROSCillator Subsystem	6.187
SENSe:SCAN Subsystem.....	6.188
SENSe:SWEep Subsystem	6.191
SENSe:TV Subsystem	6.195
SOURce Subsystem	6.196
Internal Tracking Generator	6.196
SOURce:EXTernal Subsystem	6.199
STATus Subsystem.....	6.202
SYSTEM Subsystem.....	6.213
TRACe Subsystem.....	6.222
General Trace Commands.....	6.222
TRACe:IQ Subsystem	6.225
TRIGger Subsystem	6.233
UNIT Subsystem	6.237
Alphabetical List of Commands.....	6.238
IEC/IEEE-Bus Commands of HP Models.....	6.251

6 Remote Control - Description of Commands

Notation

In the following sections, all commands implemented in the instrument are first listed in tables and then described in detail, arranged according to the command subsystems. The notation is adapted to the SCPI standard. The SCPI conformity information is included in the individual description of the commands.

Table of Commands

Command:	In the command column, the table provides an overview of the commands and their hierarchical arrangement (see indentations).
Parameter:	The parameter column indicates the requested parameters together with their specified range.
Unit:	The unit column indicates the basic unit of the physical parameters.
Comment:	In the comment column an indication is made on: <ul style="list-style-type: none"> – whether the command does not have a query form, – whether the command has only one query form – whether the command is implemented only with a certain option of the instrument

Indentations

The different levels of the SCPI command hierarchy are represented in the table by means of indentations to the right. The lower the level, the further the indentation to the right. Please note that the complete notation of the command always includes the higher levels as well.

Example: `SENSe:FREQuency:CENTer` is represented in the table as follows:

SENSe	first level
:FREQuency	second level
:CENTer	third level

Individual description

The individual description contains the complete notation of the command. An example for each command, the *RST value and the SCPI information are included as well.

The operating modes for which a command can be used are indicated by the following abbreviations:

R	Receiver
A	Spectrum analysis
A-F	Spectrum analysis - frequency domain only
A-Z	Spectrum analysis - time domain only (zero span)
FM	FM demodulator (option R&S FS-K7)

Note: *The receiver and spectrum analysis modes are implemented in the basic unit. For the other modes, the corresponding options are required.*

Upper/lower case notation Upper/lower case letters are used to mark the long or short form of the key words of a command in the description (see Chapter 5). The instrument itself does not distinguish between upper and lower case letters.

Special characters | A selection of key words with an identical effect exists for several commands. These keywords are indicated in the same line; they are separated by a vertical stroke. Only one of these keywords needs to be included in the header of the command. The effect of the command is independent of which of the keywords is used.

Example: `SENSe:FREQuency:CW|:FIXed`

The two following commands with identical meaning can be created. They set the frequency of the fixed frequency signal to 1 kHz:

`SENSe:FREQuency:CW 1E3 = SENSe:FREQuency:FIXed 1E3`

A vertical stroke in parameter indications marks alternative possibilities in the sense of "or". The effect of the command is different, depending on which parameter is used.

Example: Selection of the parameters for the command

`DISPlay:FORMat FULL | SPLit`

If parameter FULL is selected, full screen is displayed, in the case of SPLit, split screen is displayed.

[] Key words in square brackets can be omitted when composing the header (cf. Chapter 5, Optional Keywords). The full command length must be accepted by the instrument for reasons of compatibility with the SCPI standards.

Parameters in square brackets can be incorporated optionally in the command or omitted as well.

{ } Parameters in braces can be incorporated optionally in the command, either not at all, once or several times.

Description of parameters Due to the standardization, the parameter section of SCPI commands consists always of the same syntactical elements. SCPI has therefore specified a series of definitions, which are used in the tables of commands. In the tables, these established definitions are indicated in angled brackets (<...>) and will be briefly explained in the following (see also Chapter 5, Section "Parameters").

<Boolean> This keyword refers to parameters which can adopt two states, "on" and "off". The "off" state may either be indicated by the keyword **OFF** or by the numeric value 0, the "on" state is indicated by **ON** or any numeric value other than zero. Parameter queries are always returned the numeric value 0 or 1.

<numeric_value>

<num>

These keywords mark parameters which may be entered as numeric values or be set using specific keywords (character data).

The following keywords given below are permitted:

MINimum This keyword sets the parameter to the smallest possible value.

MAXimum This keyword sets the parameter to the largest possible value.

DEFault This keyword is used to reset the parameter to its default value.

UP This keyword increments the parameter value.

DOWN This keyword decrements the parameter value.

The numeric values associated to MAXimum/MINimum/DEFault can be queried by adding the corresponding keywords to the command. They must be entered following the quotation mark.

Example: SENSE:FREQUENCY:CENTer? MAXimum

returns the maximum possible numeric value of the center frequency as result.

<arbitrary block program data>

This keyword is provided for commands the parameters of which consist of a binary data block.

Common Commands

The common commands are taken from the IEEE 488.2 (IEC 625-2) standard. A particular command has the same effect on different devices. The headers of these commands consist of an asterisk "*" followed by three letters. Many common commands refer to the status reporting system which is described in detail in Chapter 5.

Command	Parameter	Function	Comment
*CAL?		Calibration Query	query only
*CLS		Clear Status	no query
*ESE	0 to 255	Event Status Enable	
*ESR?		Standard Event Status Query	query only
*IDN?		Identification Query	query only
*IST?		Individual Status Query	query only
*OPC		Operation Complete	
*OPC?		Operation Complete Query	query only
*OPT?		Option Identification Query	query only
*PCB	0 to 30	Pass Control Back	no query
*PRE	0 to 255	Parallel Poll Register Enable	
*PSC	0 1	Power On Status Clear	
*RST		Reset	no query
*SRE	0 to 255	Service Request Enable	
*STB?		Status Byte Query	query only
*TRG		Trigger	no query
*TST?		Self Test Query	query only
*WAI		Wait to continue	no query

***CAL?**

CALIBRATION QUERY initiates a calibration of the instrument and subsequently queries the calibration status. Any responses > 0 indicate errors.

***CLS**

CLEAR STATUS sets the status byte (STB), the standard event register (ESR) and the EVENT-part of the QUESTIONable and the OPERATION register to zero. The command does not alter the mask and transition parts of the registers. It clears the output buffer.

***ESE 0 to 255**

EVENT STATUS ENABLE sets the event status enable register to the value indicated. The query form *ESE? returns the contents of the event status enable register in decimal form.

***ESR?**

STANDARD EVENT STATUS QUERY returns the contents of the event status register in decimal form (0 to 255) and subsequently sets the register to zero.

***IDN?**

IDENTIFICATION QUERY queries the instrument identification.

Example: " Rohde&Schwarz, ESCI, 123456/789, 1.03"

ESCI = Device name

123456/789 = Serial number of the instrument

1.03 = Firmware version number

***IST?**

INDIVIDUAL STATUS QUERY returns the contents of the IST flag in decimal form (0 | 1). The IST flag is the status bit which is sent during a parallel poll (cf. Chapter 5).

***OPC**

OPERATION COMPLETE sets bit 0 in the event status register when all preceding commands have been executed. This bit can be used to initiate a service request (cf. Chapter 5).

***OPC?**

OPERATION COMPLETE QUERY writes message "1" into the output buffer as soon as all preceding commands have been executed (cf. Chapter 5).

***OPT?**

OPTION IDENTIFICATION QUERY queries the options included in the instrument and returns a list of the options installed. The options are separated from each other by means of commas.

Position	Option	
1	R&S FSP-B3	Audio Demodulator
2	R&S FSP-B4	OCXO
3	R&S ESPI-B2	Preselector
4	R&S FSP-B6	TV and RF Trigger
5 - 6		reserved
7	R&S FSP-B9	Tracking Generator 3 GHz / can be I/Q-modulated
8	R&S FSP-B10	Ext. Generator Control
9 - 13		reserved
14	R&S FSP-B16	LAN Interface
15 to 31		reserved
32	R&S FS-K7	FM Demodulator

Example:

B2,B4,0,B6,0,0,B9,B10,0,0,0,0,0,B16,0

***PCB 0 to 30**

PASS CONTROL BACK indicates the controller address which the IEC-bus control is to be returned to after termination of the triggered action.

***PRE 0 to 255**

PARALLEL POLL REGISTER ENABLE sets the parallel poll enable register to the indicated value. The query form *PRE? returns the contents of the parallel poll enable register in decimal form.

***PSC 0 | 1**

POWER ON STATUS CLEAR determines whether the contents of the ENABLE registers are preserved or reset during power-up.

*PSC = 0 causes the contents of the status registers to be preserved. Thus a service request can be generated when switching on the instrument, if the status registers ESE and SRE are suitably configured.

*PSC ≠ 0 'Resets the registers.

The query form *PSC? reads out the contents of the power-on-status-clear flag. The response can be 0 or 1.

***RST**

RESET sets the instrument to a defined default status. The command essentially corresponds to pressing the *PRESET* key. The default setting is indicated in the description of the commands.

***SRE 0 to 255**

SERVICE REQUEST ENABLE sets the service request enable register to the indicated value. Bit 6 (MSS mask bit) remains 0. This command determines under which conditions a service request is generated. The query form *SRE? reads the contents of the service request enable register in decimal form. Bit 6 is always 0.

***STB?**

READ STATUS BYTE QUERY reads out the contents of the status byte in decimal form.

***TRG**

TRIGGER initiates all actions in the currently active test screen expecting a trigger event. This command corresponds to `INITiate:IMMediate` (cf. Section "TRIGger Subsystem").

***TST?**

SELF TEST QUERY initiates the selftest of the instrument and outputs an error code in decimal form (0 = no error).

***WAI**

WAIT-to-CONTINUE permits servicing of subsequent commands only after all preceding commands have been executed and all signals have settled (cf. Chapter 5 and "*OPC" as well).

ABORt Subsystem

The ABORt subsystem contains the commands for aborting triggered actions. An action can be triggered again immediately after being aborted. All commands trigger events, and therefore they have no *RST value.

COMMAND	PARAMETERS	UNIT	COMMENT
:ABORt	--	--	no query
:HOLD	--	--	

ABORt

This command aborts a current measurement and resets the trigger system.

Example: "ABOR; INIT: IMM"

Characteristics: *RST value: 0
SCPI: conforming

Mode: R, A, FM

:HOLD

This command interrupts a current scan measurement.

Example: "HOLD" ' interrupts the current scan measurement

Characteristics: *RST value: -
SCPI: conforming

Mode: R

CALCulate Subsystem

The CALCulate subsystem contains commands for converting instrument data, transforming and carrying out corrections. These functions are carried out subsequent to data acquisition, i.e. following the SENSE subsystem.

The numeric suffix is used in CALCulate to make the distinction between the two measurement windows SCREEN A and SCREEN B:

CALCulate1 = Screen A

CALCulate2 = Screen B.

For commands without suffix, screen A is selected automatically.

Full Screen The settings are valid for the measurement window selected with the numeric suffix. They become effective as soon as the corresponding measurement window has been selected as active measurement window using the command DISPLAY[:WINDow<1|2>]:SELection. Triggering measurements and querying measured values is possible only in the active measurement window.

Split Screen The settings are valid for the measurement window selected by means of the numeric suffix and become effective immediately.

Note: *In receiver mode, the markers can only be activated for the scan display. Therefore, the numerical suffix is irrelevant in this operating mode.*

CALCulate<1|2>:DELTAmarker<1 to 4>:MODE ABSolute | RELative

This command switches between relative and absolute frequency input of the delta marker (or time with span = 0). It affects all delta markers independent of the measurement window.

Example: "CALC:DELT:MODE ABS" 'Switches the frequency/time indication for all delta markers to absolute values.
"CALC:DELT:MODE REL" 'Switches the frequency/time indication for all delta markers to relative to marker 1.

Characteristics: *RST value: REL
SCPI: device-specific

Mode: R, A, FM

CALCulate<1|2>:DELTAmarker<1 to 4>:AOFF

This command switches off all active delta markers in the selected measurement window (screen A or screen B).

Example: "CALC2:DELT:AOFF" 'Switches off all delta markers in screen B.

Characteristics: *RST value: -
SCPI: device-specific

Mode: R, A, FM

This command is an event and therefore has no *RST value and no query.

CALCulate<1|2>:DELTAmarker<1 to 4>:TRACe 1 to 3

This command assigns the selected delta marker to the indicated measurement curve in the indicated measurement window. The selected measurement curve must be active, i.e. its state must be different from "BLANK".

Example: "CALC:DELT3:TRAC 2" 'Assigns deltamarker 3 to trace 2 in screen A.
"CALC:DELT:TRAC 3" 'Assigns deltamarker 1 to trace 3 in screen B.

Characteristics: *RST value: -
SCPI: device-specific

Mode: R, A, FM

CALCulate<1|2>:DELTAmarker<1 to 4>:X 0 to MAX (frequency | sweep time)

This command positions the selected delta marker in the indicated measurement window to the indicated frequency (span > 0), time (span = 0) or level (APD measurement = ON or CCDF measurement = ON). The input is in absolute values or relative to marker 1 depending on the command CALCulate:DELTAmarker:MODE. If Reference Fixed measurement (CALCulate:DELTAmarker:FUNCTion:FIXed:STATE ON) is active, relative values refer to the reference position are entered. The query always returns absolute values.

Example: "CALC:DELT:MOD REL" 'Switches the input for all delta markers to relative to marker 1.
"CALC:DELT2:X 10.7MHz" 'Positions delta marker 2 in screen A 10.7 MHz to the right of marker 1.
"CALC2:DELT:X?" 'Outputs the absolute frequency/time of delta marker 1 in screen B
"CALC2:DELT:X:REL?" 'Outputs the relative frequency/time/level of delta marker 1 in screen B

Characteristics: *RST value: -
SCPI: device-specific

Mode: R, A, FM

CALCulate<1|2>:DELTamarker<1 to 4>:X:RELative?

This command queries the frequency (span > 0) or time (span = 0) of the selected delta marker relative to marker 1 or to the reference position (for CALCulate:DELTamarker:FUNCTION:FIXed:STATE ON). The command activates the corresponding delta marker, if necessary.

Example: "CALC:DELT3:X:REL?" 'Outputs the frequency of delta marker 3 in screen B relative to marker 1 or relative to the reference position.

Characteristics: *RST value: -
SCPI: device-specific

Mode: R, A, FM

CALCulate<1|2>:DELTamarker<1 to 4>:Y?

This command queries the measured value of the selected delta marker in the indicated measurement window. The corresponding delta marker will be activated, if necessary. The output is always a relative value referred to marker 1 or to the reference position (reference fixed active).

To obtain a valid query result, a complete sweep with synchronization to the sweep end must be performed between the activation of the delta marker and the query of the y value. This is only possible in single sweep mode. In receiver mode, the markers can be only activated after a scan is carried out.

Depending on the unit defined with CALC:UNIT or on the activated measuring functions, the query result is output in the units below:

- DBM | DBPW | DBUV | DBMV | DBUA: Output unit DB
- WATT | VOLT | AMPere: Output unit W | V | A
- Statistics function (APD or CCDF) on: Dimensionless output
- Result display FM (FS-K7): Hz
- Result display RF POWER (FS-K7): dB
- Result display SPECTRUM (FS-K7): dB

Example: "INIT:CONT OFF" 'Switches to single-sweep mode.
"CALC:DELT2 ON" 'Switches on delta marker 2 in screen A.
"INIT;*WAI" 'Starts a sweep and waits for its end.
"CALC:DELT2:Y?" 'Outputs measurement value of delta marker 2 in screen A.

Characteristics: *RST value: -
SCPI: device-specific

Mode: R, A, FM

CALCulate<1|2>:DELTamarker<1 to 4>:MAXimum[:PEAK]

This command positions the delta marker to the current maximum value on the measured curve. If necessary, the corresponding delta marker will be activated first.

Example: "CALC2:DELT3:MAX" 'Sets delta marker 3 in screen B to the maximum value of the associated trace.

Characteristics: *RST value: -
SCPI: device-specific

Mode: R, A, FM

This command is an event and therefore has no *RST value and no query.

CALCulate<1|2>:DELTAmarker<1 to 4>:MAXimum:NEXT

This command positions the delta marker to the next smaller maximum value on the measured curve. The corresponding delta marker will be activated first, if necessary.

Example: "CALC1 : DELT2 : MAX : NEXT" 'Sets delta marker 2 in screen A to the next 'smaller maximum value.

Characteristics: *RST value: -
SCPI: device-specific

Mode: R, A, FM

This command is an event and therefore has no *RST value and no query.

CALCulate<1|2>:DELTAmarker<1 to 4>:MAXimum:RIGHT

This command positions the delta marker to the next smaller maximum value to the right of the current value (i.e. ascending X values). The corresponding delta marker is activated first, if necessary.

Example: "CALC2 : DELT : MAX : RIGH" 'Sets delta marker 1 in screen B to the next 'smaller maximum value to the right of the 'current value.

Characteristics: *RST value: -
SCPI: device-specific

Mode: R, A, FM

This command is an event and therefore has no *RST value and no query.

CALCulate<1|2>:DELTAmarker<1 to 4>:MAXimum:LEFT

This command positions the delta marker to the next smaller maximum value to the left of the current value (i.e. descending X values). The corresponding delta marker will be activated first, if necessary.

Example: "CALC : DELT : MAX : LEFT" 'Sets delta marker 1 in screen A to the next 'smaller maximum value to the left of the 'current value.

Characteristics: *RST value: -
SCPI: device-specific

Mode: R, A, FM

This command is an event and therefore has no *RST value and no query.

CALCulate<1|2>:DELTAmarker<1 to 4>:MINimum[:PEAK]

This command positions the delta marker to the current minimum value on the measured curve. The corresponding delta marker will be activated first, if necessary.

Example: "CALC2 : DELT3 : MIN" 'Sets delta marker 3 in screen B to the 'minimum value of the associated trace.

Characteristics: *RST value: -
SCPI: device-specific

Mode: R, A, FM

This command is an event and therefore has no *RST value and no query.

CALCulate<1|2>:DELTamarker<1 to 4>:MINimum:NEXT

This command positions the delta marker to the next higher minimum value of the measured curve. The corresponding delta marker will be activated first, if necessary.

Example: "CALC1:DELT2:MIN:NEXT" 'Sets delta marker 2 in screen A to the next higher minimum value.

Characteristics: *RST value: -
SCPI: device-specific

Mode: R, A, FM

This command is an event and therefore has no *RST value and no query.

CALCulate<1|2>:DELTamarker<1 to 4>:MINimum:RIGHT

This command positions the delta marker to the next higher minimum value to the right of the current value (i.e. ascending X values). The corresponding delta marker will be activated first, if necessary.

Example: "CALC2:DELT:MIN:RIGHT" 'Sets delta marker 1 in screen B to the next higher minimum value to the right of the current value.

Characteristics: *RST value: -
SCPI: device-specific

Mode: R, A, FM

This command is an event and therefore has no *RST value and no query.

CALCulate<1|2>:DELTamarker<1 to 4>:MINimum:LEFT

This command positions the delta marker to the next higher minimum value to the left of the current value (i.e. descending X values). The corresponding delta marker will be activated first, if necessary.

Example: "CALC:DELT:MIN:LEFT" 'Sets delta marker 1 in screen A to the next higher minimum to the left of the current value.

Characteristics: *RST value: -
SCPI: device-specific

Mode: R, A, FM

This command is an event and therefore has no *RST value and no query.

CALCulate<1|2>:DELTamarker<1>:LINK ON | OFF

This command links delta marker 1 to marker 1. The x-value of delta marker 1 is kept fixed at 0. Therefore, delta marker 1 always has the same x-value as marker 1. Changing the x-value of marker 1 automatically changes the value of delta marker 1. This function is useful if marker 1 is positioned on trace 1 and delta marker 2 on trace 2.

For DELTmarker only numeric suffix 1 is permitted.

Example: "CALC:DELT:LINK ON" 'links delta marker 1 to marker 1

Characteristics: *RST value: -
SCPI: device-specific.

Mode: R, A

CALCulate<1|2>:DELTAmarker<1 to 4>:FUNCTION:FIXed[:STATe] ON | OFF

This command switches the relative measurement to a fixed reference value on or off. Marker 1 will be activated previously and a peak search will be performed, if necessary. If marker 1 is activated, its position becomes the reference point for the measurement. The reference point can then be modified with commands `CALCulate:DELTAmarker:FUNCTION:FIXed:RPOint:X` and `to:RPOint:Y` independently of the position of marker 1 and of a trace. It is valid for all delta markers in the selected measurement window as long as the function is active.

Example:

<code>"CALC2:DELTA:FUNC:FIX ON"</code>	'Switches on the measurement with fixed reference value for all delta markers in screen B.
<code>"CALC2:DELTA:FUNC:FIX:RPO:X 128 MHZ"</code>	'Sets the reference frequency in screen B to 128 MHz.
<code>"CALC2:DELTA:FUNC:FIX:RPO:Y 30 DBM"</code>	'Sets the reference level in screen B to +30 dBm

Characteristics: *RST value: OFF
SCPI: device-specific.

Mode: A

CALCulate<1|2>:DELTAmarker<1 to 4>:FUNCTION:FIXed:RPOint:MAXimum[:PEAK] <numeric_value>

This command sets the reference point level for all delta markers in the selected measurement window for a measurement with fixed reference point (`CALC:DELTA:FUNC:FIX:STAT ON`) to the peak of the selected trace.

For phase-noise measurements (`CALCulate:DELTAmarker:FUNCTION:PNOise:STATe ON`), the command defines a new reference point level for delta marker 2 in the selected measurement window.

Example: `"CALC:DELTA:FUNC:FIX:RPO:MAX"`

Characteristics: *RST value: -
SCPI: device-specific

Mode: A

This command is an event and therefore has no *RST value and no query.

CALCulate<1|2>:DELTAmarker<1 to 4>:FUNCTION:FIXed:RPOint:Y <numeric_value>

This command defines a new reference point level for all delta markers in the selected measurement window for a measurement with fixed reference point.
(`CALCulate:DELTAmarker:FUNCTION:FIXed:STATe ON`).

For phase-noise measurements (`CALCulate:DELTAmarker:FUNCTION:PNOise:STATe ON`), the command defines a new reference point level for delta marker 2 in the selected measurement window.

Example: `"CALC:DELTA:FUNC:FIX:RPO:Y -10dBm"` 'Sets the reference point level for delta markers in screen A to -10 dBm.

Characteristics: *RST value: - (`FUNCTION:FIXed[:STATe]` is set to OFF)
SCPI: device-specific

Mode: A

CALCulate<1|2>:DELTamarker<1 to 4>:FUNCTION:FIXed:RPOint:Y:OFFSet <numeric_value>

This command defines an additional level offset for the measurement with fixed reference value (CALCulate:DELTamarker:FUNCTION:FIXed:STATE ON). For this measurement, the offset is included in the display of all delta markers of the selected measurement window.

For phase-noise measurements (CALCulate:DELTamarker:FUNCTION:PNOise:STATE ON), the command defines an additional level offset which is included in the display of delta marker 2 in the selected measurement window.

Example: "CALC:DELT:FUNC:FIX:RPO:Y:OFFS 10dB"
'Sets the level offset for the measurement with fixed reference value or the phase-noise measurement in screen A to 10 dB.

Characteristics: *RST value: 0 dB
SCPI: device-specific

Mode: A

CALCulate<1|2>:DELTamarker<1 to 4>:FUNCTION:FIXed:RPOint:X <numeric_value>

This command defines a new reference frequency (span > 0) or time (span = 0) for all delta markers in the selected measurement window for a measurement with fixed reference value (CALCulate:DELTamarker:FUNCTION:FIXed:STATE ON).

For phase-noise measurements (CALCulate:DELTamarker:FUNCTION:PNOise:STATE ON), the command defines a new reference frequency or time for delta marker 2 in the selected measurement window.

Example: "CALC2:DELT:FUNC:FIX:RPO:X 128MHZ" 'Sets the reference frequency in screen B to 128 MHz.

Characteristics: *RST value: -(FUNCTION:FIXed[:STATE] is set to OFF)
SCPI: device-specific

Mode: A

CALCulate<1|2>:DELTamarker<1 to 4>:FUNCTION:PNOise[:STATE] ON | OFF

This command switches on or off the phase-noise measurement with all active delta markers in the selected measurement window. The correction values for the bandwidth and the log amplifier are taken into account in the measurement..

Marker 1 will be activated, if necessary, and a peak search will be performed. If marker 1 is activated, its position becomes the reference point for the measurement.

The reference point can then be modified with commands CALCulate:DELTamarker:FUNCTION:FIXed:RPOint:X and . . . :RPOint:Y independently of the position of marker 1 and of a trace (the same commands used for the measurement with fixed reference point).

The numeric suffix <1 to 4> with DELTamarker is not relevant for this command.

Example: "CALC:DELT:FUNC:PNO ON" 'Switches on the phase-noise measurement with all delta markers in screen A.
"CALC:DELT:FUNC:FIX:RPO:X 128 MHZ" 'Sets the reference frequency to 128 MHz.
"CALC:DELT:FUNC:FIX:RPO:Y 30 DBM" 'Sets the reference level to +30 dBm

Characteristics: *RST value: OFF
SCPI: device-specific

Mode: A

CALCulate:FEED Subsystem

The CALCulate:FEED subsystem selects the type of evaluation of the measured data. This corresponds to the selection of the Result Display in manual mode.

If the FM demodulator is active, the selection of the type of evaluation is independent of the measurement window. Therefore, the numeric suffix <1|2> is irrelevant and ignored.

Command	Parameter	Unit	Comment
CALCulate<1 2>: :FEED	<string>		no query

CALCulate<1|2>:FEED <string>

This command selects the measured data that are to be displayed.

Parameters for option R&S FS-K7 FM Demodulator:

<string>::=

'XTIM:AM'	Demodulated AM signal in level display. Equivalent to 'XTIM:RFPower'.
'XTIM:RFPower[:TDOMain]'	Demodulated AM signal in level display.
'XTIM:RFPower:AFSPpectrum<1...3>'	AF spectrum of demodulated AM signal; results referenced to trace 1 to 3.
'XTIM:FM[:TDOMain]'	Demodulated FM signal.
'XTIM:FM:AFSPpectrum<1...3>'	AF spectrum of demodulated FM signal; results referenced to trace 1 to 3.
'XTIM:SPECTrum'	RF spectrum of FM signal determined from the measured data by means of FFT.
'XTIM:PM[:TDOMain]'	Demodulated PM signal.
'XTIM:PM:AFSPpectrum<1...3>'	AF spectrum of demodulated PM signal; results referenced to trace 1 to 3.
'XTIM:AMSummary<1 to 3>'	AM results, referred to trace 1 to 3.
'XTIM:FMSummary<1 to 3>'	FM results, referred to trace 1 to 3
'XTIM:PMSummary<1 to 3>'	PM results, referred to trace 1 to 3

Example FS-K7: "INST:SEL ADEM" 'Activate FM demodulator
"CALC:FEED `XTIM:FM`" 'Selects the display of the FM signal

Characteristics: *RST value: 'XTIM:FM'
SCPI: conforming

Mode: FM

This command is only available with option R&S FS-K7 (FM Demodulator).

CALCulate:LIMit Subsystem

The CALCulate:LIMit subsystem consists of the limit lines and the corresponding limit checks. In receiver mode, upper limit lines can be defined. In analyzer mode, limit lines can be defined as upper or lower limit lines. The individual Y values of the limit lines correspond to the values of the X axis (CONTrol). The number of X and Y values must be identical.

8 limit lines can be active at the same time (marked by LIMIT1 to LIMIT8) in screen A and/or screen B. The measurement windows is selected via CALCulate 1 (screen A) or 2 (screen B).

The limit check can be switched on separately for each measurement screen and limit line. WINDow1 corresponds to screen A, WINDow2 to screen B.

Each limit line can be assigned a name (max. 8 letters) under which the line is stored in the instrument. An explanatory comment can also be given for each line (max. 40 characters).

Example (analyzer mode):

Definition and use of a new limit line 5 for trace 2 in screen A and trace 1 in screen B with the following features:

- upper limit line
- absolute X axis in the frequency domain
- 5 ref. values: 126 MHz/-40 dB, 127 MHz/-40 dB, 128 MHz/-20 dB, 129 MHz/-40 dB, 130 MHz/-40 dB
- relative Y axis with unit dB
- absolute threshold value at -35 dBm
- no safety margin

Definition of the line:

- | | |
|-------------------------------------|---|
| 1. Defining the name: | CALC:LIM5:NAME 'TEST1' |
| 2. Entering the comment: | CALC:LIM5:COMM 'Upper limit line' |
| 3. Associated trace in screen A: | CALC1:LIM5:TRAC 2 |
| 4. Associated trace in screen B: | CALC2:LIM5:TRAC 1 |
| 5. Defining the X axis range: | CALC:LIM5:CONT:DOM FREQ |
| 6. Defining the X axis scaling: | CALC:LIM5:CONT:MODE ABS |
| 7. Defining the Y axis unit: | CALC:LIM5:UNIT DB |
| 8. Defining the Y axis scaling: | CALC:LIM5:UPP:MODE REL |
| 9. Defining the X axis values: | CALC:LIM5:CONT 126MHZ, 127MHZ, 128MHZ,
129 MHZ, 130MHZ |
| 10. Defining the y values: | CALC:LIM5:UPP -40, -40, -30, -40, -40 |
| 11. Defining the y threshold value: | CALC:LIM5:UPP:THR -35DBM |

The definition of the safety margin and shifting in X and/or Y direction can take place as from here (see commands below).

Switching on and evaluating the line in screen A:

- | | |
|---|------------------------|
| 1. Switching on the line in screen A: | CALC1:LIM5:UPP:STAT ON |
| 2. Switching on the limit check in screen A: | CALC1:LIM5:STAT ON |
| 3. Starting a new measurement with synchronization: | INIT;*WAI |
| 4. Querying the limit check result: | CALC1:LIM5:FAIL? |

Switching on and evaluating the line in screen B is performed in the same way by using CALC2 instead of CALC1.

COMMAND	PARAMETERS	UNIT	COMMENT
CALCulate<1 2> :LIMit<1 to 8> :TRACe :STATe :UNIT :FAIL? :CLEAr [:IMMediate] :COMMeNt :COPIY :NAME :DELeTe	<numeric_value> <Boolean> DBM DBPW WATT DBUV DBMV VOLT DBUA AMPere DBPT DB DBUV_M DBUA_M	-- -- -- -- -- --	query only no query

CALCulate<1|2>:LIMit<1 to 8>:TRACe 1 to 3

This command assigns a limit line to a trace in the indicated measurement window.

Examples: "CALC:LIM2:TRAC 3" 'Assigns limit line 2 to trace 3 in screen A.
"CALC2:LIM2:TRAC 1" 'Assigns limit line 2 to trace 1 in screen B at the same time.

Characteristics: *RST value: 1
SCPI: device-specific

Mode: R, A, FM

CALCulate<1|2>:LIMit<1 to 8>:STATe ON | OFF

This command switches on or off the limit check for the selected limit line in the selected measurement window. The result of the limit check can be queried with CALCulate:LIMit<1 to 8>:FAIL?.

Example: "CALC:LIM:STAT ON" 'Switches on the limit check for limit line 1 in screen A.
"CALC2:LIM:STAT OFF" 'Switches off the limit check for limit line 1 in screen B.

Characteristics: *RST value: OFF
SCPI: conforming

Mode: R, A, FM

CALCulate<1|2>:LIMit<1 to 8>:UNIT DBM | DBPW | WATT | DBUV | DBMV | VOLT |DBUA | AMPere | DB | DBT | DBUV_M | DBMV_M

This command defines the unit of the selected limit line. The definition is valid independently of the measurement window.

Upon selection of the unit DB the limit line is automatically switched to the relative mode. For units different from DB the limit line is automatically switched to absolute mode.

Example: "CALC:LIM4:UNIT DBUV" 'Sets the unit of limit line 4 to dB μ V.

Characteristics: *RST value: DBM
SCPI: device-specific

Mode: R, A, FM

In receiver mode the units DBM, DBUV, DBUA, DBPW, DBPT, DBUV_M, and DBUA_M are available

In analyzer mode all units are available except for DBPT.

CALCulate<1|2>:LIMit<1 to 8>:FAIL?

This command queries the result of the limit check of the limit line indicated in the selected measurement window. It should be noted that a complete sweep must have been performed for obtaining a valid result. A synchronization with *OPC, *OPC? or *WAI should therefore be provided. The result of the limit check responds with 0 for PASS, 1 for FAIL, and 2 for MARGIN.

This command is not available in receiver mode.

Example: "INIT; *WAI " 'Starts a new sweep and waits for its end.
"CALC2:LIM3:FAIL?" 'Queries the result of the check for limit
'line 3 in screen B.

Characteristics: *RST value: -
SCPI: conforming

Mode: A, FM

CALCulate<1|2>:LIMit<1 to 8>:CLEar[:IMMediate]

This command deletes the result of the current limit check for all limit lines in the selected measurement window.

This command is not available in receiver mode.

Example: "CALC:LIM:CLE" 'Deletes the result of the limit check in screen A

Characteristics: *RST value: -
SCPI: conforming

Mode: A, FM

This command is an event and therefore has no *RST value.

CALCulate<1|2>:LIMit<1 to 8>:COMMeNt <string>

This command defines a comment for the limit line selected (max. 40 characters). The comment is independent from the measurement window.

Example: "CALC:LIM5:COMM 'Upper limit for spectrum'"
'Defines the comment for limit line 5.

Characteristics: *RST value: blank comment
SCPI: device-specific

Mode: R, A, FM

CALCulate<1|2>:LIMit<1 to 8>:COpy 1 to 8 | <name>

This command copies one limit line onto another one. It is independent of the measurement window. The name of the limit line may consist of max 8 characters.

Parameter: 1 to 8 ::= number of the new limit line or:
<name> ::= name of the new limit line given as a string

Example: "CALC:LIM1:COpy 2" 'Copies limit line 1 to line 2.
"CALC:LIM1:COpy 'GSM2' " 'Copies limit line 1 to a new line named
'GSM2'.

Characteristics: *RST value: --
SCPI: device-specific

Mode: R, A, FM

This command is an event and therefore has no *RST value and no query.

CALCulate<1|2>:LIMit<1 to 8>:NAME <name of limit line>

This command assigns a name to a limit line numbered 1 to 8. If it does not exist already, a limit line with this name is created. The command is independent of the measurement window.

The name of the limit line may contain a maximum of 8 characters.

Example: "CALC:LIM1:NAME 'GSM1' " 'Assigns the name 'GSM1' to limit line 1.

Characteristics: *RST value: 'REM1' to 'REM8' for lines 1 to 8
SCPI: device-specific

Mode: R, A, FM

CALCulate<1|2>:LIMit<1 to 8>:DELete

This command deletes the selected limit line. The command is independent of the measurement window.

Example: "CALC:LIM1:DEL " 'Deletes limit line 1.

Characteristics: *RST value: --
SCPI: device-specific

Mode: R, A, FM

This command is an event and therefore has no *RST value and no query.

CALCulate:LIMit:ACPower Subsystem

The CALCulate:LIMit:ACPower subsystem defines the limit check for adjacent channel power measurement.

COMMAND	PARAMETERS	UNIT	COMMENT
CALCulate<1 2> LIMit<1 to 8> :ACPower [:STATe] :ACHannel [:RELative] :STATe :ABSolute :STATe :RESult? :ALTErnate<1 2> [:RELative] :STATe :ABSolute :STATe :RESult?	<Boolean> <numeric_value>, <numeric_value> <Boolean> <numeric_value>, <numeric_value> <Boolean> -- <numeric_value>, <numeric_value> <Boolean> <numeric_value>, <numeric_value> <Boolean> --	 DB, DB DBM, DBM DB, DB DBM, DBM --	 query only query only

CALCulate<1|2>:LIMit<1 to 8>:ACPower[:STATe] ON | OFF

This command switches on and off the limit check for adjacent channel power measurements in the selected measurement window. The commands CALCulate:LIMit:ACPower:ACHannel:STATe or CALCulate:LIMit:ACPower:ALTErnate:STATe must be used in addition to specify whether the limit check is to be performed for the upper/lower adjacent channel or for the alternate adjacent channels. The numeric suffixes <1 to 8> are irrelevant for this command.

Example: "CALC:LIM:ACP ON" 'Switches on the ACP limit check in screen A.

Characteristics: *RST value: OFF
SCPI: device-specific

Mode: A

CALCulate<1|2>:LIMit<1 to 8>:ACPower:ACHannel[:RELative] 0 to 100dB, 0 to 100dB

This command defines the relative limit of the upper/lower adjacent channel for adjacent channel power measurements in the selected measurement window. The reference value for the relative limit value is the measured channel power.

It should be noted that the relative limit value has no effect on the limit check as soon as it is below the absolute limit value defined with CALCulate:LIMit:ACPower:ACHannel:ABSolute. This mechanism allows automatic checking of the absolute basic values of adjacent channel power as defined in mobile radio standards.

The numeric suffixes <1 to 8> are irrelevant for this command.

Parameter: The first numeric value is the limit for the upper (lower) adjacent channel. The second value is ignored but must be indicated for reasons of compatibility with the FSE family.

Example: "CALC:LIM:ACP:ACH 30DB, 30DB" 'Sets the relative limit value in 'screen A for the power in the lower 'and upper adjacent channel to '30 dB below the channel power.

Characteristics: *RST value: 0 dB
SCPI: device-specific

Mode: A

CALCulate<1|2>:LIMit<1 to 8>:ACPpower:ACHannel[:RELative]:STATe ON | OFF

This command activates the limit check for the relative limit value of the adjacent channel when adjacent channel power measurement is performed. Before the command, the limit check must be activated using `CALCulate:LIMit:ACPpower:STATe ON`.

The result can be queried with `CALCulate:LIMit:ACPpower:ACHannel:RESult?`. It should be noted that a complete measurement must be performed between switching on the limit check and the result query, since otherwise no valid results are available.

The numeric suffixes <1 to 8> are irrelevant for this command.

Example:

<code>"CALC:LIM:ACP:ACH 30DB, 30DB"</code>	'Sets the relative limit value in screen A for the power in the lower and upper adjacent channel to 30 dB below the channel power.
<code>"CALC:LIM:ACP:ACH:ABS -35DBM, -35DBM"</code>	'Sets the absolute limit value in screen A for the power in the lower and upper adjacent channel to -35 dBm.
<code>"CALC:LIM:ACP ON"</code>	'Switches on globally the limit check for the channel/adjacent channel measurement in screen A.
<code>"CALC:LIM:ACP:ACH:REL:STAT ON"</code>	'Switches on the check of the relative limit values for adjacent channels in screen A.
<code>"CALC:LIM:ACP:ACH:ABS:STAT ON"</code>	'Switches on the check of absolute limit values for the adjacent channels in screen A.
<code>"INIT;*WAI"</code>	'Starts a new measurement and waits for the sweep end.
<code>"CALC:LIM:ACP:ACH:RES?"</code>	'Queries the limit check result in the adjacent channels in screen A.

Characteristics: *RST value: OFF
SCPI: device-specific

Mode: A

CALCulate<1|2>:LIMit<1 to 8>:ACPpower:ACHannel:ABSolute -200DBM to 200DBM, -200 to 200DBM

This command defines the absolute limit value for the lower/upper adjacent channel during adjacent-channel power measurement (Adjacent Channel Power) in the selected measurement window.

It should be noted that the absolute limit value has no effect on the limit check as soon as it is below the relative limit value defined with `CALCulate:LIMit:ACPpower:ACHannel:RELative`. This mechanism allows automatic checking of the absolute basic values of adjacent channel power as defined in mobile radio standards.

The numeric suffixes <1 to 8> in LIMit are irrelevant for this command.

Parameter: The first value is the limit for the lower and the upper adjacent channel. The second limit value is ignored but must be indicated for reasons of compatibility with the FSE family.

Example:

<code>"CALC:LIM:ACP:ACH:ABS -35DBM, -35DBM"</code>	'Sets the absolute limit value in screen A for the power in the lower and upper adjacent channel to -35 dBm.
--	--

Characteristics: *RST value: -200DBM
SCPI: device-specific

Mode: A

CALCulate<1|2>:LIMit<1 to 8>:ACPpower:ACHannel:ABSolute:STATe ON | OFF

This command activates the limit check for the adjacent channel when adjacent-channel power measurement (Adjacent Channel Power) is performed. Before the command, the limit check for the channel/adjacent-channel measurement must be globally switched on using `CALC:LIM:ACP ON`. The result can be queried with `CALCulate:LIMit:ACPpower:ACHannel:RESult?`. It should be noted that a complete measurement must be performed between switching on the limit check and the result query, since otherwise no valid results are available.

The numeric suffixes <1 to 8> in LIMit are irrelevant for this command.

Example:	<code>"CALC:LIM:ACP:ACH 30DB, 30DB"</code>	'Sets the relative limit value in screen A for the power in the lower and upper adjacent channel to 30 dB below the channel power.
	<code>"CALC:LIM:ACP:ACH:ABS -35DBM, -35DBM"</code>	'Sets the absolute limit value in screen A for the power in the lower and upper adjacent channel to -35 dBm.
	<code>"CALC:LIM:ACP ON"</code>	'Switches on globally the limit check for the channel/adjacent channel measurement in screen A.
	<code>"CALC:LIM:ACP:ACH:REL:STAT ON"</code>	'Switches on the check of the relative limit values for adjacent channels in screen A.
	<code>"CALC:LIM:ACP:ACH:ABS:STAT ON"</code>	'Switches on the check of absolute limit values for the adjacent channels in screen A.
	<code>"INIT;*WAI"</code>	'Starts a new measurement and waits for the sweep end.
	<code>"CALC:LIM:ACP:ACH:RES?"</code>	'Queries the limit check result in the adjacent channels in screen A.

Characteristics: *RST value: OFF
SCPI: device-specific

Mode: A

CALCulate<1|2>:LIMit<1 to 8>:ACPpower:ACHannel:RESult?

This command queries the result of the limit check for the upper/lower adjacent channel in the selected measurement window when adjacent channel power measurement is performed.

If the power measurement of the adjacent channel is switched off, the command produces a query error.

The numeric suffixes <1 to 8> are irrelevant for this command.

Parameter: The result is returned in the form <result>, <result> where <result> = PASSED | FAILED, and where the first returned value denotes the lower, the second denotes the upper adjacent channel.

Example:

"CALC:LIM:ACP:ACH 30DB, 30DB"	'Sets the relative limit value in screen A for the power in the lower and upper adjacent channel to 30 dB below the channel power.
"CALC:LIM:ACP:ACH:ABS -35DBM, -35DBM"	Sets the absolute limit value in screen A for the power in the lower and upper adjacent channel to -35 dB.
"CALC:LIM:ACP ON"	'Switches on globally the limit check for the channel/adjacent channel measurement in screen A.
"CALC:LIM:ACP:ACH:STAT ON"	'Switches on the limit check for the adjacent channels in screen A.
"INIT;*WAI"	'Starts a new measurement and waits for the sweep end.
"CALC:LIM:ACP:ACH:RES?"	'Queries the limit check result in the adjacent channels in screen A.

Characteristics: *RST value: --
SCPI: device-specific

Mode: A

This command is a query and therefore has no *RST value.

CALCulate<1|2>:LIMit<1 to 8>:ACPowEr:ALTernate<1|2>[:RELative] 0 to 100dB, 0 to 100dB.

This command defines the limit for the first/second alternate adjacent channel in the selected measurement window for adjacent channel power measurements. The reference value for the relative limit value is the measured channel power.

The numeric suffix after ALTernate<1|2> denotes the first or the second alternate channel. The numeric suffixes <1 to 8> are irrelevant for this command.

It should be noted that the relative limit value has no effect on the limit check as soon as it is below the absolute limit defined with CALCulate:LIMit:ACPowEr:ALTernate<1|2>:ABSolute. This mechanism allows automatic checking of the absolute basic values of adjacent channel power as defined in mobile radio standards.

Parameter: The first value is the limit for the lower and the upper alternate adjacent channel. The second limit value is ignored but must be indicated for reasons of compatibility with the FSE family.

Example: "CALC:LIM:ACP:ALT2 30DB, 30DB" 'Sets the relative limit value in 'screen A for the power in the lower 'and upper alternate adjacent 'channel to 30 dB below the channel 'power.

Characteristics: *RST value: 0DB
SCPI: device-specific

Mode: A

CALCulate<1|2>:LIMit<1 to 8>:ACPpower:ALternate<1|2>[:RELative]:STATe ON | OFF

This command activates the limit check for the first/second alternate adjacent channel in the selected measurement window for adjacent channel power measurements. Before the command, the limit check must be activated using `CALCulate:LIMit:ACPpower:STATe ON`.

The numeric suffix after `ALternate<1|2>` denotes the first or the second alternate channel. The numeric suffixes <1 to 8> are irrelevant for this command.

The result can be queried with `CALCulate:LIMit:ACPpower:ALternate<1|2>:RESult?`. It should be noted that a complete measurement must be performed between switching on the limit check and the result query, since otherwise no valid results are obtained.

Example:

<code>"CALC:LIM:ACP:ALT2 30DB, 30DB"</code>	'Sets the relative limit value in screen A for the power in the lower and upper second alternate adjacent channel to 30 dB below the channel power.
<code>"CALC:LIM:ACP:ALT2:ABS -35DBM, -35DBM"</code>	'Sets the absolute limit value in screen A for the power in the lower and upper second alternate adjacent channel to -35 dBm.
<code>"CALC:LIM:ACP ON"</code>	'Switches on globally the limit check for the channel/adjacent channel measurement in screen A.
<code>"CALC:LIM:ACP:ACH:REL:STAT ON"</code>	'Switches on the check of the relative limit values for the alternate adjacent channels in screen A.
<code>"CALC:LIM:ACP:ACH:ABS:STAT ON"</code>	'Switches on the check of absolute limit values for the alternate adjacent channels in screen A.
<code>"INIT;*WAI"</code>	'Starts a new measurement and waits for the sweep end.
<code>"CALC:LIM:ACP:ACH:RES?"</code>	'Queries the limit check result in the second alternate adjacent channels in screen A.

Characteristics: *RST value: OFF
SCPI: device-specific

Mode: A

CALCulate<1|2>:LIMit<1 to 8>:ACPpower:ALternate<1|2>:ABSolute -200DBM to 200DBM,
-200DBM to .200DBM

This command defines the absolute limit value for the lower/upper alternate adjacent channel power measurement (Adjacent Channel Power) in the selected measurement window.

The numeric suffix after **ALternate<1|2>** denotes the first or the second alternate channel. The numeric suffixes <1 to 8> are irrelevant for this command.

It should be noted that the absolute limit value for the limit check has no effect as soon as it is below the relative limit value defined with **CALCulate:LIMit:ACPpower:ALternate<1|2>:RELative**. This mechanism allows automatic checking of the absolute basic values defined in mobile radio standards for the power in adjacent channels.

Parameter: The first value is the limit for the lower and the upper alternate adjacent channel. The second limit value is ignored but must be indicated for reasons of compatibility with the FSE family.

Example: "CALC:LIM:ACP:ALT2:ABS -35DBM, -35DBM"

'Sets the absolute limit value in
'screen A for the power in the lower
'and upper second alternate
'adjacent channel to -35 dBm.

Characteristics: *RST value: -200DBM
SCPI: device-specific

Mode: A

CALCulate<1|2>:LIMit<1 to 8>:ACPpower:ALternate<1|2>:ABSolute:STATe ON | OFF

This command activates the limit check for the first/second alternate adjacent channel in the selected measurement window for adjacent channel power measurement (Adjacent Channel Power).

Before the command, the limit check must be globally switched on for the channel/adjacent channel power with the command `CALCulate:LIMit:ACPpower:STATe ON`.

The numeric suffix after `ALternate<1|2>` denotes the first or the second alternate channel. The numeric suffixes <1 to 8> are irrelevant for this command.

The result can be queried with `CALCulate:LIMit:ACPpower:ALternate<1|2>:RESult?`. It should be noted that a complete measurement must be performed between switching on the limit check and the result query, since otherwise no valid results are available.

Example:

<code>"CALC:LIM:ACP:ALT2 30DB, 30DB"</code>	'Sets the relative limit value in screen A for the power in the lower and upper second alternate adjacent channel to 30 dB below the channel power.
<code>"CALC:LIM:ACP:ALT2:ABS -35DBM, -35DBM"</code>	'Sets the absolute limit value in screen A for the power in the lower and upper second alternate adjacent channel to -35 dBm.
<code>"CALC:LIM:ACP ON"</code>	'Switches on globally the limit check for the channel/adjacent channel measurement in screen A.
<code>"CALC:LIM:ACP:ACH:REL:STAT ON"</code>	Switches on the check of the relative limit values for the alternative adjacent channels in screen A.
<code>"CALC:LIM:ACP:ACH:ABS:STAT ON"</code>	'Switches on the check of absolute limit values for the alternative adjacent channels in screen A.
<code>"INIT;*WAI"</code>	'Starts a new measurement and waits for the sweep end.
<code>"CALC:LIM:ACP:ACH:RES?"</code>	'Queries the limit check result in the second alternate adjacent channels in screen A.

Characteristics: *RST value: OFF
SCPI: device-specific

Mode: A

CALCulate<1|2>:LIMit<1 to 8>:ACPpower:ALTErnate<1|2>:RESult?

This command queries the result of the limit check for the first/second alternate adjacent channel in the selected measurement window for adjacent channel power measurements.

The numeric suffix after ALTErnate<1|2> denotes the first or the second alternate channel. The numeric suffixes <1 to 8> are irrelevant for this command.

If the power measurement of the adjacent channel is switched off, the command produces a query error.

Parameter: The result is returned in the form <result>, <result> where <result> = PASSED | FAILED and where the first (second) returned value denotes the lower (upper) alternate adjacent channel.

Example:

"CALC:LIM:ACP:ALT2 30DB, 30DB"	'Sets the relative limit value in screen A for the power in the lower and upper second alternate adjacent channel to 30 dB below the channel power.'
"CALC:LIM:ACP:ALT2:ABS -35DBM, -35DBM"	'Sets the absolute limit value in screen A for the power in the lower and upper second alternate adjacent channel to -35 dBm.'
"CALC:LIM:ACP ON"	'Switches on globally the limit check for the channel/adjacent channel measurement in screen A.'
"CALC:LIM:ACP:ALT:STAT ON"	'Switches on the limit check for the adjacent channels in screen A.'
"INIT;*WAI"	'Starts a new measurement and waits for the sweep end.'
"CALC:LIM:ACP:ALT:RES?"	'Queries the limit check result in the second alternate adjacent channels in screen A.'

Characteristics: *RST value: --
SCPI: device-specific

Mode: A

This command is a query and therefore has no *RST value.

CALCulate:LIMit:CONTrol Subsystem

The CALCulate:LIMit:CONTrol subsystem defines the x axis (CONTrol-axis).

COMMAND	PARAMETERS	UNIT	COMMENT
CALCulate<1 2> :LIMit<1...8> :CONTrol [:DATA] :DOMain :OFFSet :MODE :SHIFt :SPACing	<numeric_value>,<numeric_value>.. FREQuency TIME <numeric_value> RELative ABSolute <numeric_value> LINear LOGarithmic	HZ S HZ S HZ S	

CALCulate<1|2>:LIMit<1 to 8>:CONTrol[:DATA] <numeric_value>,<numeric_value>..

This command defines the X axis values (frequencies or times) of the upper or lower limit lines. The values are defined independently of the measurement window.

The number of values for the CONTrol axis and for the corresponding UPPer and/or LOWEr limit lines have to be identical. Otherwise default values are entered for missing values or not required values are deleted.

In analyzer mode, the unit of values depends on the frequency or time domain of the X axis, i.e. it is HZ with CALC:LIM:CONT:DOM FREQ und S bei CALC:LIM:CONT:DOM TIME.

Example:

```
"CALC:LIM2:CONT 1MHz,30MHz,100MHz, 300MHz,1GHz"
'Defines 5 reference values for the X axis of
'limit line 2
```

```
"CALC:LIM2:CONT?"
'Outputs the reference values for the X axis of
'limit line 2 separated by a comma.
```

Characteristics: *RST value: - (LIMit:STATe is set to OFF)
SCPI: conforming

Mode: R, A, FM

CALCulate<1|2>:LIMit<1 to 8>:CONTrol:DOMain FREQuency | TIME

This command defines the frequency or time domain for the x axis values.

Example:

```
"CALC:LIM2:CONT:DOM TIME"
'Defines the time domain for the X axis of limit
'line 2.
```

Characteristics: *RST value: FREQuency
SCPI: device-specific

Mode: A, FM

CALCulate<1|2>:LIMit<1 to 8>:CONTRol:OFFSet <numeric_value>

This command defines an offset for the X axis value of the selected relative limit line in the frequency or time domain.

The unit of values depends on the frequency or time domain of the X axis, i.e. it is HZ with `CALC:LIM:CONT:DOM FREQ` und S bei `CALC:LIM:CONT:DOM TIME`.

Example: `"CALC:LIM2:CONT:OFFS 100us"` 'Sets the X offset for limit line 2 (defined in 'the time domain) to 100µs.

Characteristics: *RST value: 0
SCPI: device-specific

Mode: A, FM

CALCulate<1|2>:LIMit<1 to 8>:CONTRol:MODE RELative | ABSolute

This command selects the relative or absolute scaling for the X axis of the selected limit line. The definition is independent of the measurement window.

Example: `"CALC:LIM2:CONT:MODE REL"` 'Defines the X axis of limit line 2 as relatively 'scaled.

Characteristics: *RST value: ABSolute
SCPI: device-specific

Mode: A, FM

CALCulate<1|2>:LIMit<1 to 8>:CONTRol:SHIFt <numeric_value>

This command moves a limit line by the indicated value in x direction. In contrast to `CALC:LIM:CONT:OFFS`, the line is shifted by modifying the individual x values and not by means of an additive offset. The shift is independent of the measurement window.

In the analyzer mode, the unit of values depends on the frequency or time domain of the X axis, i.e. it is HZ with `CALC:LIM:CONT:DOM FREQ` und S bei `CALC:LIM:CONT:DOM TIME`.

Example: `"CALC:LIM2:CONT:SHIF 50KHZ"` 'Shifts all reference values of limit line 2 by '50 kHz.

Characteristics: *RST value: --
SCPI: device-specific

Mode: R, A, FM

This command is an event and therefore has no *RST value and no query.

CALCulate<1|2>:LIMit<1...8>:CONTRol:SPACing LINear | LOGarithmic

This command selects linear or logarithmic interpolation for the calculation of limit lines from frequency points.

Example: `"CALC:LIM:CONT:SPAC LIN"`

Characteristics: *RST value: LIN
SCPI: device-specific

Modes: R, A

CALCulate:LIMit:LOWer Subsystem

The CALCulate:LIMit:LOWer subsystem defines the lower limit line. This subsystem is not available in receiver mode.

COMMAND	PARAMETERS	UNIT	COMMENT
CALCulate<1 2> :LIMit<1 to 8> :LOWer [:DATA]	<numeric_value>,<numeric_value>..	DBM DB DEG RAD S HZ PCT	
:STATe	<Boolean>	--	
:OFFSet	<numeric_value>	DB DEG RAD S HZ PCT	
:MARGin	<numeric_value>	DB DEG RAD S HZ PCT	
:MODE	RELative ABSolute	--	
:SHIFt	<numeric_value>	DB DEG RAD S HZ PCT	
:SPACing	LINear LOGarithmic		
:THReshold	<numeric_value>	DBM DB DEG RAD S HZ PCT	

CALCulate<1|2>:LIMit<1 to 8>:LOWer[:DATA] <numeric_value>,<numeric_value>..

This command defines the values for the selected lower limit line independently of the measurement window.

The number of values for the CONTROL axis and for the corresponding LOWER limit line has to be identical. Otherwise default values are entered for missing values or not necessary values are deleted.

The unit must be identical with the unit selected by CALC:LIM:UNIT. If no unit is indicated, the unit defined with CALC:LIM:UNIT is automatically used.

If the measured values are smaller than the LOWER limit line, the limit check signals errors.

Example: "CALC:LIM2:LOW -30,-40,-10,-40,-30" 'Defines 5 lower limit values for limit line 2 in 'the preset unit.
"CALC:LIM2:LOW?" 'Outputs the lower limit values of limit line 2 'separated by a comma.

Characteristics: *RST value: - (LIMit:STATe is set to OFF)
SCPI: conforming

Mode: A, FM

CALCulate<1|2>:LIMit<1 to 8>:LOWer:STATe ON | OFF

This command switches on or off the indicated limit line in the selected measurement window. The limit check is activated separately with `CALC:LIM:STAT ON`.

In analyzer mode, the result of the limit check can be queried with `CALCulate:LIMit<1 to 8>:FAIL?`.

Example: `"CALC:LIM4:LOW:STAT ON"` 'Switches on limit line 4 (lower limit) in 'screen A.
 `"CALC2:LIM4:LOW:STAT ON"` 'Switches on limit line 4 (lower limit) also in 'screen B.

Characteristics: *RST value: OFF
 SCPI: conforming

Mode: A, FM

CALCulate<1|2>:LIMit<1 to 8>:LOWer:OFFSet <numeric_value>

This command defines an offset for the Y axis of the selected relative lower limit line. In contrast to `CALC:LIM:LOW:SHIFT`, the line is not shifted by modifying the individual Y values but by means of an additive offset. The offset is independent of the measurement window.

Example: `"CALC:LIM2:LOW:OFFS 3dB"` 'Shifts limit line 2 in the corresponding 'measurement windows by 3 dB upwards.

Characteristics: *RST value: 0
 SCPI: device-specific

Mode: A, FM

CALCulate<1|2>:LIMit<1 to 8>:LOWer:MARGin <numeric_value>

This command defines a margin to a lower limit line, at which out-of-limit values are signalled (if the limit check is active), but not handled as a violation of the limit value. The margin is independent of the measurement window.

Only the unit dB is available in spectrum analysis mode.

Example: `"CALC:LIM:LOW:MARG 10dB"`

Characteristics: *RST value: 0
 SCPI: device-specific

Mode: A, FM

CALCulate<1|2>:LIMit<1 to 8>:LOWer:MODE RELative | ABSolute

This command selects the relative or absolute scaling for the Y axis of the selected lower limit line. The setting is independent of the measurement window.

Selecting RELative causes the unit to be switched to DB.

Example: `"CALC:LIM:LOW:MODE REL"` 'Defines the Y axis of limit line 2 as relative 'scaled.

Characteristics: *RST value: ABSolute
 SCPI: device-specific

Mode: A, FM

CALCulate<1|2>:LIMit<1 to 8>:LOWer:SHIFt <numeric_value>

This command shifts a limit line by the indicated value in Y direction. In contrast to CALC:LIM:LOW:OFFS, the line is shifted by modifying the individual Y values but not by means of an additive offset. The shift is independent of the measurement window.

Example: "CALC:LIM3:LOW:SHIF 20DB" 'Shifts all Y values of limit line 3 by 20 dB.

Characteristics: *RST value: --
SCPI: device-specific

Mode: A, FM

This command is an event and therefore has no *RST value and no query.

CALCulate<1|2>:LIMit<1 to 8>:LOWer:SPACing LINear | LOGarithmic

This command selects linear or logarithmic interpolation for the lower limit line.

Example: "CALC:LIM:LOW:SPAC LIN"

Characteristics: *RST value: LIN
SCPI: device-specific

Mode: R, A

CALCulate<1|2>:LIMit<1 to 8>:LOWer:THReshold <numeric_value>

This command defines an absolute threshold value for limit lines with relative Y axis scaling independently of the measurement window. The absolute threshold value is used in the limit check as soon as it exceeds the relative limit value.

The unit must correspond to the unit selected with CALC:LIM:UNIT (except dB which is not allowed). If no unit is indicated, the unit defined with CALC:LIM:UNIT is automatically used (exception: dBm instead of dB).

Example: "CALC:LIM2:LOW:THR -35DBM" 'Defines an absolute threshold value for limit line 2.

Characteristics: *RST value: -200 dBm
SCPI: device-specific

Mode: A, FM

CALCulate:LIMit:UPPer Subsystem

The CALCulate:LIMit:UPPer subsystem defines the upper limit line.

COMMAND	PARAMETERS	UNIT	COMMENT
CALCulate<1 2> :LIMit<1 to 8> :UPPer [:DATA] :STATe :OFFSet :MARGin :MODE :SPACing :SHIFt :SPACing :THReshold	<numeric_value>,<numeric_value>.. <Boolean> <numeric_value> <numeric_value> RELative ABSolute LINear LOGarithmic <numeric_value> LINear LOGarithmic <numeric_value>	DBM DB -- DB DB -- -- DB DBM DB	

CALCulate<1|2>:LIMit<1 to 8>:UPPer[:DATA] <numeric_value>,<numeric_value>..

This command defines the values for the upper limit lines independently of the measurement window.

The number of values for the CONTROL axis and for the corresponding UPPER and/or LOWER limit line have to be identical. Otherwise default values are entered for missing values or not necessary values are deleted.

The unit must be identical with the unit selected by CALC:LIM:UNIT. If no unit is indicated, the unit defined with CALC:LIM:UNIT is automatically used.

In analyzer mode, the limit check signals errors if the measured values exceed the UPPER limit line.

Example: "CALC:LIM2:UPP -10,0,0,-10,-5" 'Defines 5 upper limit values for limit line 2 in the preset unit.

"CALC:LIM2:UPP?" 'Outputs the upper limit values for limit line 2 separated by a comma.

Characteristics: *RST value: - (LIMit:STATe is set to OFF)
SCPI: conforming

Mode: R, A, FM

CALCulate<1|2>:LIMit<1 to 8>:UPPer:STATe ON | OFF

This command switches on or off the indicated limit line in the selected measurement window. The limit check is activated separately with `CALC:LIM:STAT ON`.

In analyzer mode, the result of the limit check can be queried with `CALCulate:LIMit<1 to 8>:FAIL?`.

Example: `"CALC1:LIM4:UPP:STAT ON"` 'Switches on limit line 4 (upper limit) in 'screen A.
 `"CALC2:LIM4:UPP:STAT ON"` 'Switches on limit line 4 (upper limit) in 'screen B.

Characteristics: *RST value: OFF
 SCPI: conforming

Mode: R, A, FM

CALCulate<1|2>:LIMit<1 to 8>:UPPer:OFFSet <numeric_value>

This command defines an offset for the Y axis of the selected relative upper limit line. In contrast to `CALC:LIM:UPP:SHIFt`, the line is not shifted by modifying the individual Y values but by means of an additive offset. The offset is independent of the measurement window.

Example: `"CALC:LIM2:UPP:OFFS 3dB"` 'Shifts limit line 2 by 3 dB upwards in the 'corresponding measurement windows.

Characteristics: *RST value: 0
 SCPI: device-specific

Mode: A, FM

CALCulate<1|2>:LIMit<1 to 8>:UPPer:MARGin <numeric_value>

This command defines a margin to an upper limit line, at which out-of-limit values are signalled (if the limit check is active), but not handled as a violation of the limit value. The margin is independent of the measurement window.

Example: `"CALC:LIM2:UPP:MARG 10dB"` 'Defines the margin of limit line 2 to 10 dB 'below the limit value.

Characteristics: *RST value: 0
 SCPI: device-specific

Mode: R, A, FM

CALCulate<1|2>:LIMit<1 to 8>:UPPer:MODE RELative | ABSolute

This command selects the relative or absolute scaling for the Y axis of the selected upper limit line. The setting is independent of the measurement window.

Selecting RELative causes the unit to be switched to DB.

Example: "CALC:LIM2:UPP:MODE REL" 'Defines the Y axis of limit line 2 as relative 'scaled.

Characteristics: *RST value: ABSolute
SCPI: device-specific

Mode: A, FM

CALCulate<1|2>:LIMit<1 to 8>:UPPer:SHIFt <numeric_value>

This command moves a limit line by the indicated value in Y direction. In contrast to CALC:LIM:UPP:OFFS, the line is shifted by modifying the individual Y values and not by means of an additive offset. The shift is independent of the measurement window.

Example: "CALC:LIM3:UPP:SHIF 20DB" 'Shifts all Y values of limit line 3 by 20 dB.

Characteristics: *RST value: --
SCPI: device-specific

Mode: R, A, FM

This command is an event and therefore has no *RST value and no query.

CALCulate<1|2>:LIMit<1 to 8>:UPPer:SPACing LINear | LOGarithmic

This command selects linear or logarithmic interpolation for the upper limit line.

Example: "CALC:LIM:UPP:SPAC LIN"

Characteristics: *RST value: LIN
SCPI: device-specific

Mode: A

CALCulate<1|2>:LIMit<1 to 8>:UPPer:THReshold <numeric_value>

This command defines an absolute threshold value for limit lines with relative Y axis scaling independently of the measurement window. The absolute threshold value is used in the limit check as soon as it exceeds the relative limit value.

The unit must correspond to the unit selected with CALC:LIM:UNIT (except dB which is not possible). If no unit is indicated, the unit defined with CALC:LIM:UNIT is automatically used (exception: dBm instead of dB).

Example: "CALC:LIM2:UPP:THR -35DBM" 'Defines an absolute threshold value 'for limit line 2.

Characteristics: *RST value: -200 dBm
SCPI: device-specific

Mode: A, FM

CALCulate<1|2>:LIMit<1 to 8>:UPPer:SPACing LINear | LOGarithmic

This command selects linear or logarithmic interpolation for the upper limit line.

Example: "CALC:LIM:UPP:SPAC LIN"

Characteristics: *RST value: LIN
SCPI: device-specific

Modes: R, A

CALCulate:MARKer Subsystem

The CALCulate:MARKer subsystem checks the marker functions in the instrument. The measurement windows are assigned to CALCulate 1 (screen A) or 2 (screen B).

COMMAND	PARAMETERS	UNIT	COMMENT
CALCulate<1 2>			
:MARKer<1 to 4>			
[:STATe]	<Boolean>	--	
:AOFF			no query
:TRACe	<numeric_value>	--	
:X	<numeric_value>	HZ S DBM DB	
:SLIMits			
[:STATe]	<Boolean>		
:LEFT	<numeric_value>	HZ S	
:RIGHT	<numeric_value>	HZ S	
:COUNt	<Boolean>	--	
:RESolution	<numeric_value>	HZ	
:FREQuency?	--	--	query only
:COUPled			
[:STATe]	<Boolean>		
:SCOupled			
[:STATe]	<Boolean>		
:LOEXclude	<Boolean>		
:Y?	--	--	query only
:PERCent	<numeric_value>	PCT	
:MAXimum		--	
[:PEAK]	--	--	no query
:NEXT	--	--	no query
:RIGHT	--	--	no query
:LEFT	--	--	no query
:MINimum			
[:PEAK]	--	--	no query
:NEXT	--	--	no query
:RIGHT	--	--	no query
:LEFT	--	--	no query
:PEXCursion	<numeric_value>	DB	

CALCulate<1|2>:MARKer<1 to 4>[:STATe] ON | OFF

This command switches on or off the currently selected marker in the selected measurement window. If no indication is made, marker 1 is selected automatically. If marker 2, 3 or 4 is selected and used as a delta marker, it is switched to marker mode.

Example: "CALC:MARK3 ON" 'Switches marker 3 in screen A on or to marker mode.

Characteristics: *RST value: OFF
SCPI: device-specific

Mode: R, A, FM

CALCulate<1|2>:MARKer<1 to 4>:AOFF

This command switches off all active markers in the selected measurement window. All delta markers and active marker/delta marker measurement functions are switched off.

Example: "CALC:MARK:AOFF" 'Switches off all markers in screen A.

Characteristics: *RST value: -
SCPI: device-specific

Mode: R, A, FM

This command is an event and therefore has no *RST value and no query.

CALCulate<1|2>:MARKer<1 to 4>:TRACe 1 to 3

This command assigns the selected marker (1 to 4) to the indicated measurement curve in the selected measurement window. The corresponding trace must be active, i.e. its status must be different from "BLANK".

If necessary the corresponding marker is switched on prior to the assignment.

Example: "CALC:MARK3:TRAC 2" 'Assigns marker 3 in screen A to trace 2.

"CALC2:MARK:TRAC 3" 'Assigns marker 1 in screen B to trace 3.

Characteristics: *RST value -
SCPI: device-specific

Mode: R, A, FM

CALCulate<1|2>:MARKer<1 to 4>:X 0 to MAX (frequency | sweep time)

This command positions the selected marker to the indicated frequency (span > 0), time (span = 0) or level (APD measurement or CCDF measurement ON) in the selected measurement window. If marker 2, 3 or 4 is selected and used as delta marker, it is switched to marker mode.

Available units: receiver: Hz; analyzer: Hz

Example: "CALC1:MARK2:X 10.7MHz" 'Positions marker 2 in screen A to frequency 10.7 MHz.

Characteristics: *RST value: -
SCPI: device-specific

Mode: R, A, FM

CALCulate<1|2>:MARKer<1 to 4>:X:SLIMits[:STATe] ON | OFF

This command switches between a limited (ON) and unlimited (OFF) search range in the selected measurement window. The function is independent of the selection of a marker, i.e. the numeric suffix MARKer<1 to 4> is irrelevant.

If the time domain power measurement is active, this command limits the evaluation range on the trace.

Example: "CALC:MARK:X:SLIM ON" 'Switches on search limitation in screen A.

Characteristics: *RST value: OFF
SCPI: device-specific

Mode: R, A, FM

CALCulate<1|2>:MARKer<1 to 4>:X:SLIMits:LEFT 0 to MAX (frequency | sweep time)

This command sets the left limit of the search range for markers and delta markers in the selected measurement window. Depending on the x axis domain the indicated value defines a frequency (span > 0) or time (span = 0). The function is independent of the selection of a marker, i.e. the numeric suffix in MARKer<1 to 4> is irrelevant.

If the time domain power measurement is active, this command limits the evaluation range to the trace.

Note: *The function is only available if the search limit for marker and delta marker is switched on (CALC:MARK:X:SLIM ON).*

Example: "CALC:MARK:X:SLIM ON" 'Switches the search limit function on for screen A.
"CALC:MARK:X:SLIM:LEFT 10MHz" 'Sets the left limit of the search range in screen A to 10 MHz.

Characteristics: *RST value: - (is set to the left diagram border on switching on search limits)
SCPI: device-specific

Mode: R, A, FM

CALCulate<1|2>:MARKer<1 to 4>:X:SLIMits:RIGHT 0 to MAX (frequency | sweep time)

This command sets the right limit of the search range for markers and delta markers in the selected measurement window. Depending on the x axis domain the indicated value defines a frequency (span > 0) or time (span = 0). The function is independent of the selection of a marker, i.e. the numeric suffix in MARKer<1 to 4> is irrelevant.

If the time domain power measurement is active, this command limits the evaluation range to the trace.

Note: *The function is only available if the search limit for marker and delta marker is switched on (CALC:MARK:X:SLIM ON).*

Example: "CALC:MARK:X:SLIM ON" 'Switches the search limit function on for screen A.
"CALC:MARK:X:SLIM:RIGH 20MHz" 'Sets the right limit of the search range in screen A to 20 MHz.

Characteristics: *RST value: - is set to the right diagram border on switching on search limits)
SCPI: device-specific

Mode: R, A, FM

CALCulate<1|2>:MARKer<1 to 4>:COUNT ON | OFF

This command switches on or off the frequency counter at the marker position in the selected measurement window. The count result is queried with `CALCulate:MARKer:COUNT:FREQUENCY?`.

Frequency counting is possible only for one marker at a time for each measurement window. If it is activated for another marker, it is automatically de-activated for the previous marker.

It should be noted that a complete sweep must be performed after switching on the frequency counter to ensure that the frequency to be measured is actually reached. The synchronization to the sweep end required for this is possible only in single-sweep mode.

Example:

"INIT:CONT OFF"	'Switches to single-sweep mode.
"CALC:MARK ON"	'Switches on marker 1 in screen A.
"CALC:MARK:COUN ON"	'Switches on the frequency counter for marker 1.
"INIT;*WAI"	'Starts a sweep and waits for the end.
"CALC:MARK:COUN:FREQ?"	'Outputs the measured value in screen A.

Characteristics: *RST value: OFF
SCPI: device-specific

Mode: A

CALCulate<1|2>:MARKer<1 to 4>:COUNT:RESolution 0.1 | 1 | 10 | 100 | 1000 | 10000 Hz

This command specifies the resolution of the frequency counter in the selected measurement window. The setting is independent of the selected marker, i.e. the numeric suffix in `MARKer<1 to 4>` is irrelevant.

Example: "CALC:MARK:COUN:RES 1kHz" 'Sets the resolution of the frequency counter to 1 kHz.

Characteristics: *RST value: 1kHz
SCPI: device-specific

Mode: A

CALCulate<1|2>:MARKer<1 to 4>:COUNT:FREQUENCY?

This command queries the result of the frequency counter for the indicated marker in the selected measurement window. Before the command, the frequency counter should be switched on and a complete measurement performed to obtain a valid count result. Therefore, a single sweep with synchronization must be performed between switching on the frequency counter and querying the count result.

Example:

"INIT:CONT OFF"	'Switches to single-sweep mode.
"CALC:MARK2 ON"	'Switches marker 2 in screen A.
"CALC:MARK2:COUN ON"	'Switches the frequency counter for marker 2.
"INIT;*WAI"	'Starts a sweep and waits for the end.
"CALC:MARK2:COUN:FREQ?"	'Outputs the measured value of marker 2 in screen A.

Characteristics: *RST value: -
SCPI: device-specific

Mode: A

This command is only a query and therefore has no *RST value.

CALCulate<1|2>:MARKer<1 to 4>:COUPlEd[:STATe] ON | OFF

This command switches the coupling of the receiver frequency to the marker on or off.

Example: "CALC:MARK:COUP ON" marker coupling is switched on

Characteristics: *RST value: OFF
SCPI: device-specific

Mode: R

The numeric suffix in `MARKer<1 to 4>` is irrelevant.

CALCulate<1|2>:MARKer<1 to 4>:SCOupled[:STATe] ON | OFF

This command switches the coupling of the receiver frequency at the marker frequency on or off.

Example: " :CALC:MARK:SCO ON "

Characteristics: *RST value: ON
SCPI: device-specific

Mode: R

The numeric suffix in MARKer<1 to 4> is not significant.

CALCulate<1|2>:MARKer<1 to 4>:LOEXclude ON | OFF

This command switches the local oscillator suppression for peak search on or off. This setting is valid for all markers and delta markers in all measurement windows.

Example: "CALC:MARK:LOEX ON "

Characteristics: *RST value: ON
SCPI: device-specific

Mode: A-F, FM

The numeric suffixes 1|2 and 1 to 4 are irrelevant.

CALCulate<1|2>:MARKer<1 to 4>:Y?

This command queries the measured value of the selected marker in the selected measurement window. The corresponding marker is activated before or switched to marker mode, if necessary.

To obtain a valid query result, a complete sweep with synchronization to the sweep end must be performed between the activation of the marker and the query of the y value. This is only possible in single sweep mode.

The query result is output in the unit determined with CALCulate:UNIT.

In the default setting, the output is made depending on the unit determined with CALC:UNIT; only with linear level scaling is the output in %.

If the FM Demodulator (FS-K7) is activated, the query result is output in the following units:

- Result display FM: Hz
- Result display RF POWER LOG: dBm
- Result display RF POWER LIN: %
- Result display SPECTRUM LOG: dBm
- Result display SPECTRUM LIN: %

Example: "INIT:CONT OFF" 'Switches to single-sweep mode.
"CALC:MARK2 ON" 'Switches marker 2 in screen A.
"INIT;*WAI" 'Starts a sweep and waits for the end.
"CALC:MARK2:Y?" 'Outputs the measured value of marker 2 in screen A.

Characteristics: *RST value: -
SCPI: device-specific

Mode: R, A, FM

CALCulate<1|2>:MARKer<1 to 4>:Y:PERCent 0 to100%

This command positions the selected marker in the selected window to the given probability. If marker 2, 3 or 4 is selected and used as a delta marker, it is switched to marker mode.

Note: *The command is only available with the CCDF measurement switched on.
The associated level value can be determined with the CALC:MARK:X? command.*

Example: "CALC1:MARK:Y:PERC 95PCT" 'Positions marker 1 in screen A to a
'probability of 95%.

Characteristics: *RST value: -
SCPI: device-specific

Mode: A

CALCulate<1|2>:MARKer<1 to 4>:MAXimum[:PEAK]

This command positions the marker to the current maximum value of the corresponding trace in the selected measurement window. The corresponding marker is activated first or switched to the marker mode.

Note: *If no maximum value is found on the trace (level spacing to adjacent values < peak excursion), an execution error (error code: -200) is produced.*

Example: "CALC:MARK2:MAX" 'Positions marker 2 in screen A to the maximum value of
'the trace.

Characteristics: *RST value: -
SCPI: device-specific

Mode: R, A, FM

This command is an event and therefore has no *RST value and no query.

CALCulate<1|2>:MARKer<1 to 4>:MAXimum:NEXT

This command positions the marker to the next smaller maximum value of the corresponding trace in the selected measurement window.

Note: *If no next smaller maximum value is found on the trace (level spacing to adjacent values < peak excursion), an execution error (error code: -200) is produced.*

Example: "CALC:MARK2:MAX:NEXT" 'Positions marker 2 in screen A to the next
'lower maximum value.

Characteristics: *RST value: -
SCPI: device-specific

Mode: R, A, FM

This command is an event and therefore has no *RST value and no query.

CALCulate<1|2>:MARKer<1 to 4>:MAXimum:RIGHT

This command positions the marker to the next smaller maximum value to the right of the current value (i.e. in ascending X values) on the corresponding trace in the selected measurement window.

Note: *If no next smaller maximum value is found on the trace (level spacing to adjacent values < peak excursion), an execution error (error code: -200) is produced.*

Example: "CALC:MARK2:MAX:RIGHT" 'Positions marker 2 in screen A to the next
'lower maximum value to the right of the
'current value.

Characteristics: *RST value: -
SCPI: device-specific

Mode: R, A, FM

This command is an event and therefore has no *RST value and no query.

CALCulate<1|2>:MARKer<1 to 4>:MAXimum:LEFT

This command positions the marker to the next smaller maximum value to the left of the current value (i.e. in descending X values) on the trace in the selected measurement window.

Note: *If no next smaller maximum value is found on the trace (level spacing to adjacent values < peak excursion), an execution error (error code: -200) is produced.*

Example: "CALC:MARK2:MAX:LEFT" 'Positions marker 2 in screen A to the next lower maximum value to the left of the current value.'

Characteristics: *RST value: -
SCPI: device-specific

Mode: R, A, FM

This command is an event and therefore has no *RST value and no query.

CALCulate<1|2>:MARKer<1 to 4>:MINimum[:PEAK]

This command positions the marker to the current minimum value of the corresponding trace in the selected measurement window. The corresponding marker is activated first or switched to marker mode, if necessary.

Note: *If no minimum value is found on the trace (level spacing to adjacent values < peak excursion), an execution error (error code: -200) is produced.*

Example: "CALC:MARK2:MIN" 'Positions marker 2 in screen A to the minimum value of the trace.'

Characteristics: *RST value: -
SCPI: device-specific

Mode: R, A, FM

This command is an event and therefore has no *RST value and no query.

CALCulate<1|2>:MARKer<1 to 4>:MINimum:NEXT

This command positions the marker to the next higher minimum value of the corresponding trace in the selected measurement window.

Note: *If no next higher minimum value is found on the trace (level spacing to adjacent values < peak excursion), an execution error (error code: -200) is produced.*

Example: "CALC:MARK2:MIN:NEXT" 'Positions marker 2 in screen A to the next higher maximum value.'

Characteristics: *RST value: -
SCPI: device-specific

Mode: R, A, FM

This command is an event and therefore has no *RST value and no query.

CALCulate<1|2>:MARKer<1 to 4>:MINimum:RIGHT

This command positions the marker to the next higher minimum value to the right of the current value (i.e. in ascending X direction) on the corresponding trace in the selected measurement window.

Note: *If no next higher minimum value is found on the trace (level spacing to adjacent values < peak excursion), an execution error (error code: -200) is produced.*

Example: "CALC:MARK2:MIN:RIGHT" 'Positions marker 2 in screen A to the next higher minimum value to the right of the current value.'

Characteristics: *RST value: -
SCPI: device-specific

Mode: R, A, FM

This command is an event and therefore has no *RST value and no query.

CALCulate<1|2>:MARKer<1 to 4>:MINimum:LEFT

This command positions the marker to the next higher minimum value to the left of the current value (i.e. in descending X direction) on the corresponding trace in the selected measurement window.

Note: *If no next higher minimum value is found on the trace (level spacing to adjacent values < peak excursion), an execution error (error code: -200) is produced.*

Example: "CALC:MARK2:MIN:LEFT" 'Positions marker 2 in screen A to the next higher minimum value to the left of the current value.'

Characteristics: *RST value: -
SCPI: device-specific

Mode: R, A, FM

This command is an event and therefore has no *RST value and no query.

CALCulate<1|2>:MARKer<1 to 4>:PEXCursion <numeric_value>

This command defines the peak excursion., i.e. the spacing below a trace maximum which must be attained before a new maximum is recognized, or the spacing above a trace minimum which must be attained before a new minimum is recognized. The set value is valid for all markers and delta markers. The unit depends on the selected operating mode.

Example: "CALC:MARK:PEXC 10dB" 'Defines peak excursion 10 dB in SPECTRUM mode
"CALC:MARK:PEXC 100 HZ" Defines peak excursion 100 Hz in FM DEMOD mode

Characteristics: *RST value: 6dB
SCPI: device-specific

Mode: R, A, FM

The numeric suffix in MARKer<1 to 4> is irrelevant.

```
"CALC:MARK:FUNC:FPE:SORT X" ' sets the sort mode to increasing
                               ' X values
"CALC:MARK:FUNC:FPE 3"      ' searches the 3 highest maxima for trace 1
"CALC:MARK:FUNC:COUN?"     ' queries the number of maxima found
"CALC:MARK:FUNC:Y?"        ' queries the level of maxima found
"CALC:MARK:FUNC:X?"        ' queries the frequencies (span <> 0) or
                               ' time (span = 0) of maxima found.
```

Characteristics: *RST value: --
SCPI: device-specific

Mode: A

CALCulate<1|2>:MARKer<1 to 4>:FUNCTION:FPEaks:COUNT?

This query reads out the number of maxima found during the search. If no search for maxima has been performed, 0 is returned.

Example: "CALC:MARK:FUNC:FPE 3" ' searches the 3 highest maxima for trace 1
"CALC:MARK:FUNC:FPE:COUN?" ' queries the number of maxima found

Characteristics: *RST value: --
SCPI: device-specific

Mode: A

CALCulate<1|2>:MARKer<1 to 4>:FUNCTION:FPEaks:X?

This query reads out the list of X values of the maxima found. The number of available values can be queried with CALC:MARK:FUNC:FPEaks:COUNT?.

With sort mode X, the X values are in increasing order; with sort mode Y the order corresponds to the decreasing order of the Y values.

Example: "CALC:MARK:FUNC:FPE:SORT Y" ' sets the sort mode to decreasing y values
"CALC:MARK:FUNC:FPE 3" searches the 3 highest maxima for trace 1
"CALC:MARK:FUNC:FPE:COUN?" ' queries the number of maxima found
"CALC:MARK:FPE:FUNC:X?" ' queries the frequencies (span <> 0) or
' time (span = 0) of the maxima found.

Returned values:
"107.5E6,153.8E6,187.9E6" ' frequencies in increasing order
"2.05E-3,2.37E-3, 3.71e-3" ' times in increasing order

Characteristics: *RST value: --
SCPI: device-specific

Mode: A

CALCulate<1|2>:MARKer<1 to 4>:FUNction:FPEaks:Y?

This query reads out the list of X values of the maxima found. The number of available values can be queried with `CALC:MARK:FUNC:FPEaks:COUNT?`.

With sort mode X, the X values are in increasing order; with sort mode Y the order corresponds to the decreasing order of the Y values.

Example: `"CALC:MARK:FUNC:FPE:SORT Y"` ' sets the sort mode to decreasing y values
`"CALC:MARK:FUNC:FPE 3"` ' searches the 3 highest maxima for trace 1
`"CALC:MARK:FUNC:FPE:COUN?"` ' queries the number of maxima found
`"CALC:MARK:FUNC:FPE:Y?"` ' queries the levels of the maxima found.

Return value:

`"-37.5, -58.3, -59.6"` ' level in decreasing order

Characteristics: *RST value: --
 SCPI: device-specific

Mode: A

CALCulate<1|2>:MARKer<1 to 4>:FUNction:FPEaks:SORT X | Y

This command sets the sort mode for the search for maxima:

X the maxima are sorted in the list of responses according to increasing X values
 Y the maxima are sorted in the list of responses according to decreasing Y values

Example: `"CALC:MARK:FUNC:FPE:SORT Y"` ' sets the sort mode to decreasing y values

Characteristics: *RST value: --
 SCPI: device-specific

Mode: A

CALCulate<1|2>:MARKer<1 to 4>:FUNction:NDBDown <numeric_value>

This command defines the level spacing of the two delta markers to the right and left of marker 1 in the selected measurement window. Marker 1 is always used as the reference marker. The numeric suffix <1 to 4> is irrelevant for this command.

The temporary markers T1 and T2 are positioned by n dB below the active reference marker. The frequency spacing of these markers can be queried with `CALCulate:MARKer:FUNction:NDBDown:RESult?`.

Example: `"CALC:MARK:FUNC:NDBD 3dB"` 'Sets the level spacing in screen A to 3 dB.

Characteristics: *RST value: 6dB
 SCPI: device-specific

Mode: A

CALCulate<1|2>:MARKer<1 to 4>:FUNction:NDBDown:STATe ON | OFF

This command switches the "N dB Down" function on or off in the selected measurement window. Marker 1 is activated first, if necessary. The numeric suffix <1 to 4> is irrelevant for this command.

Example: `"CALC:MARK:FUNC:NDBD:STAT ON"` 'Switches on the N-dB-down function in 'screen A.

Characteristics: *RST value: OFF
 SCPI: device-specific

Mode: A

CALCulate<1|2>:MARKer<1 to 4>:FUNCtion:NDBDown:RESult?

This command queries the frequency spacing (bandwidth) of the N-dB-down markers in the selected measurement window. The numeric suffix <1 to 4> is irrelevant for this command.

A complete sweep with synchronization to sweep end must be performed between switching on the function and querying the measured value in order to obtain a valid query result. This is only possible in single sweep mode.

Example:

"INIT:CONT OFF "	'Switches to single-sweep mode.
"CALC:MARK:FUNC:NDBD ON "	'Switches on the n-dB-down function in screen A.
"INIT;*WAI "	'Starts a sweep and waits for the end.
"CALC:MARK:FUNC:NDBD:RES? "	'Outputs the measured value of screen A.

Characteristics: *RST value: -
SCPI: device-specific

Mode: A

This command is only a query and therefore has no *RST value.

CALCulate<1|2>:MARKer<1 to 4>:FUNCtion:NDBDown:FREQUency?

This command queries the two frequencies of the N-dB-down marker in the selected measurement window. The numeric suffix <1 to 4> is irrelevant for this command. The two frequency values are separated by comma and output in ascending order.

A complete sweep with synchronization to sweep end must be performed between switching on the function and querying the measured value to obtain a valid query result. This is only possible in single sweep mode.

Example:

"INIT:CONT OFF "	'Switches to single-sweep mode.
"CALC:MARK:FUNC:NDBD ON "	'Switches on the n-dB-down function in screen A.
"INIT;*WAI "	'Starts a sweep and waits for the end.
"CALC:MARK:FUNC:NDBD:FREQ? "	'Outputs the frequencies of the temporary markers in screen A.

Characteristics: *RST value: -
SCPI: device-specific

Mode: A

This command is only a query and therefore has no *RST value.

CALCulate<1|2>:MARKer<1 to 4>:FUNCtion:NDBDown:TIME?

This command queries the two time values of the N-dB-down marker in the selected measurement window. The numeric suffix <1 to 4> is irrelevant for this command. The two time values are separated by comma and output in ascending order.

A complete sweep with synchronization to sweep end must be performed between switching on the function and querying the measured value to obtain a valid query result. This is only possible in single sweep mode.

Example:

"INIT:CONT OFF "	'Switches to single-sweep mode.
"CALC:MARK:FUNC:NDBD ON "	'Switches on the n-dB-down function in screen A.
"INIT;*WAI "	'Starts a sweep and waits for the end.
"CALC:MARK:FUNC:NDBD:TIM? "	'Outputs the time values of the temporary markers in screen A.

Characteristics: *RST value: -
SCPI: device-specific

Mode: A

This command is only a query and therefore has no *RST value.

CALCulate<1|2>:MARKer<1 to 4>:FUNCTion:DEModulation[:STATe] ON | OFF

This command switches on or off the audio demodulator when the indicated marker is reached in the selected measurement window. In the frequency domain (span > 0) the hold time can be defined at the corresponding marker position with CALCulate:MARKer:FUNCTion:DEModulation:HOLD. In the time domain (span = 0) the demodulation is permanently active.

Example: "CALC2:MARK3:FUNC:DEM ON" 'Switches on the demodulation for marker 3 in 'screen B.

Characteristics: *RST value: OFF
SCPI: device-specific

Mode: A

CALCulate<1|2>:MARKer<1 to 4>:FUNCTion:DEModulation:HOLDoff 10ms to 1000s

This command defines the hold time at the marker position for the demodulation in the frequency domain (span > 0). The setting is independent of the measurement window and the selected marker, i.e. the suffixes <1|2> and <1 to 4> are irrelevant

Example: "CALC:MARK:FUNC:DEM:HOLD 3s"

Characteristics: *RST value: - (DEModulation is set to OFF)
SCPI: device-specific

Mode: A

CALCulate<1|2>:MARKer<1 to 4>:FUNCTion:DEModulation:CONTinuous ON | OFF

This command switches on or off the continuous demodulation in the frequency domain (span > 0) in the selected measurement window. Thus acoustic monitoring of the signals can be performed in the frequency domain. The function does not depend on the selected marker, i.e. the numeric suffix <1 to 4> is irrelevant.

Example: "CALC2:MARK3:FUNC:DEM:CONT ON" 'Switches on the continuous 'demodulation in screen B.

Characteristics: *RST value: OFF
SCPI: device-specific

Mode: A

CALCulate<1|2>:MARKer<1 to 4>:FUNCtion:MDEPth:[:STATe]

This command switches on the measurement of the AM modulation depth. An AM-modulated carrier is required on the screen for correct operation. If necessary, marker 1 is previously activated and set to the largest signal available.

The level value of marker 1 is regarded as the carrier level. On activating the function, marker 2 and marker 3 are automatically set as delta markers symmetrically to the carrier to the adjacent maxima of the trace.

If the position of delta marker 2 is changed, delta marker 3 is moved symmetrically with respect to the reference marker (marker 1). If the position of delta marker 3 is changed, fine adjustment can be performed independently of delta marker 2.

The R&S ESCI calculates the power at the marker positions from the measured levels.

The AM modulation depth is calculated from the ratio of power values at the reference marker and the delta markers. If the two AM sidebands differ in power, the average value of the two power values is used for calculating the AM modulation depth.

The numeric suffix <1 to 4> of :MARKer is irrelevant with this command.

Example:	"CALC:MARK:X 10MHZ "	'Sets the reference marker (marker 1) to 'the carrier signal at 10 MHz
	"CALC:MARK:FUNC:MDEP ON"	'Switches on the modulation depth 'measurement in screen A.
	"CALC:DELT2:X 10KHZ "	'Sets delta markers 2 and 3 to the signals 'at 10 kHz from the carrier signal
	"CALC:DELT3:X 9.999KHZ "	'Corrects the position of delta marker 3 'relative to delta marker 2.

Characteristics: *RST value: OFF
SCPI: device-specific

Mode: A

CALCulate<1|2>:MARKer<1 to 4>:FUNCtion:MDEPth:RESult?

This command queries the AM modulation depth in the indicated measurement window.

A complete sweep with synchronization to sweep end must be performed between switching on the function and querying the measured value to obtain a valid query result. This is only possible in single sweep mode.

The numeric suffix <1 to 4> of :MARKer is irrelevant for this command.

Example:	"INIT:CONT OFF "	'Switches to single-sweep mode.
	"CALC:MARK:X 10MHZ "	'Sets the reference marker (marker 1) to 'the carrier signal at 10 MHz.
	"CALC:MARK:FUNC:MDEP ON"	'Switches on the modulation depth 'measurement in screen A.
	"INIT;*WAI "	'Starts a sweep and waits for the end.
	"CALC:MARK:FUNC:MDEP:RES? "	'Outputs the measured value of screen A.

Characteristics: *RST value: -
SCPI: device-specific

Mode: A

This command is only a query and therefore has no *RST value.

CALCulate<1|2>:MARKer<1 to 4>:FUNCtion:TOI[:STATe] ON | OFF

This command initiates the measurement of the third-order intercept point.

A two-tone signal with equal carrier levels is expected at the RF input of the instrument. Marker 1 and marker 2 (both normal markers) are set to the maximum of the two signals. Delta marker 3 and delta marker 4 are positioned to the intermodulation products. The delta markers can be modified separately afterwards with the commands `CALCulate:DELTAmarker3:X` and `CALCulate:DELTAmarker4:X`.

The third-order intercept is calculated from the level spacing between the normal markers and the delta markers.

The numeric suffix <1 to 4> of :MARKer is irrelevant for this command.

Example: `"CALC:MARK:FUNC:TOI ON"` 'Switches on the measurement of the third-order intercept in screen A.

Characteristics: *RST value: OFF
SCPI: device-specific

Mode: A

CALCulate<1|2>:MARKer<1 to 4>:FUNCtion:TOI:RESult?

This command queries the third-order intercept point measurement in the indicated measurement window.

A complete sweep with synchronization to sweep end must be performed between switching on the function and querying the measured value to obtain a valid query result. This is only possible in single sweep mode.

The numeric suffix <1 to 4> of :MARKer is irrelevant of this command.

Example: `"INIT:CONT OFF"` 'Switches to single-sweep mode.
 `"CALC:MARK:FUNC:TOI ON"` 'Switches the intercept measurement in 'screen A.
 `"INIT;*WAI"` 'Starts a sweep and waits for the end.
 `"CALC:MARK:FUNC:TOI:RES?"` 'Outputs the measured value of screen A.

Characteristics: *RST value: -
SCPI: device-specific

Mode: A

This command is only a query and therefore has no *RST value.

CALCulate<1|2>:MARKer<1 to 4>:FUNCtion:CENTer

This command sets the receiver or center frequency of the selected measurement window equal to the frequency of the indicated marker.

If marker 2, 3 or 4 is selected and used as delta marker, it is switched to the marker mode.

Example: `"CALC:MARK2:FUNC:CENt"` 'Sets the receiver frequency to the frequency of 'marker 2.

Characteristics: *RST value: -
SCPI: device-specific

Mode: R, A-F

This command is an "event" and therefore has no *RST value and no query.

CALCulate<1|2>:MARKer<1 to 4>:FUNCtion:CSTep

This command sets the step width of the receiver or center frequency in the selected measurement window to the X value of the current marker. If marker 2, 3 or 4 is selected and used as delta marker, it is switched to the marker mode.

Example: "CALC2:MARK2:FUNC:CST" 'Sets the receiver frequency to the same value as the frequency of marker 2.

Characteristics: *RST value: -
SCPI: device-specific

Mode: A-F

This command is an event and therefore has no *RST value and no query.

CALCulate<1|2>:MARKer<1 to 4>:FUNCtion:REFerence

This command sets the reference level in the selected measurement window to the power measured by the indicated marker. If marker 2, 3 or 4 is selected and used as delta marker, it is switched to marker mode.

Example: "CALC:MARK2:FUNC:REF" 'Sets the reference level of screen A to the the level of marker 2.

Characteristics: *RST value: -
SCPI: device-specific

Mode: A

This command is an event and therefore has no *RST value and no query.

CALCulate:MARKer:FUNCTion:ADEMod Subsystem

The CALCulate:MARKer:FUNCTion:ADEMod subsystem contains the marker functions for the Option FM Demodulator FS-K7.

COMMAND	PARAMETERS	UNIT	COMMENT
CALCulate<1 2> :MARKer :FUNCTion :ADEMod :FM [:RESult<1...3>?] :PM [:RESult?] :AFRequency [:RESult<1...3>?] :FERRor [:RESult<1...3>?] :SINad :RESult<1...3>? :THD :RESult<1...3>? :CARRier [:RESult<1...3>?]	PPEak MPEak MIDDLE RMS PPEak MPEak MIDDLE RMS		Option FM-Demodulator query only query only query only query only query only query only

CALCulate<1|2>:MARKer<1 to 4>:FUNCTion:ADEMod:FM[:RESult<1 to 3>]?

PPEak | MPEak | MIDDLE | RMS

This command queries the results of FM modulation measurement. The numeric suffix marks the selected trace 1 to 3.

PPEak Result of measurement with detector +PK
MPEak Result of measurement with detector -PK
MIDDLE Result of averaging \pm PK/2
RMS Result of rms measurement

Example: "CALC:MARK:FUNC:ADEM:FM? PPE" 'Queries the peak value.

Characteristics: *RST value: -
SCPI: device-specific

Mode: FM

This command is only available with Option R&S FS-K7 (FM Demodulator).

CALCulate<1|2>:MARKer<1 to 4>:FUNCTion:ADEMod:PM[:RESult<1 to 3>]?

PPEak | MPEak | MIDDLE | RMS

This command queries the results of PM modulation measurement. The numeric suffix marks the selected trace 1 to 3.

PPEak Result of measurement with detector +PK
MPEak Result of measurement with detector -PK
MIDDLE Result of averaging \pm PK/2
RMS Result of rms measurement

Example: "CALC:MARK:FUNC:ADEM:PM? PPE" 'Queries the peak value.

Characteristics: *RST value: -
SCPI: device-specific

Mode: FM

This command is only available with Option R&S FS-K7 (FM Demodulator).

CALCulate<1|2>:MARKer<1 to 4>:FUNCTION:ADEMod:AFRequency[:RESult<1 to 3>]?

This command queries the audio frequency with analog demodulation. The numeric suffix marks the selected trace 1 to 3.

Note: If several demodulation modes are activated simultaneously with commands *SENS:ADEM:FM:TYPE*, *SENS:ADEM:RFP:TYPE*, *SENS:ADEM:FM:AFSP:TYPE* or *SENS:ADEM:RFP:AFSP*, the audio frequency of the display mode selected with *CALC:FEED* is returned.

Example:	Example:	"ADEM ON"	'Switches on FM demodulator
		"CALC:FEED 'XTIM:AM:TDOM"	'Switches on result display AM
or		"CALC:FEED 'XTIM:FM:TDOM"	'Switches on result display FM
or		"CALC:FEED 'XTIM:FM:AFSP"	'Switches on result displayAF spectrum of FM
		"DISP:TRAC ON"	and trace
or		"CALC:FEED 'XTIM:RFP:AFSP"	'Switches on result display
		"DISP:TRAC ON"	'AF spectrum of RF power signal and trace
		"CALC:MARK:FUNC:ADEM:AFR?"	'Queries the audio frequency

Characteristics: *RST value: -
SCPI: device-specific

Mode: FM

This command is only available with Option R&S FS-K7 (FM Demodulator).

CALCulate<1|2>:MARKer<1 to 4>:FUNCTION:ADEMod:FERRor[:RESult<1 to 3>]?

This command queries the frequency error with FM demodulation. The numeric suffix marks the selected trace 1 to 3. The offset thus determined differs from that calculated in the command *[SENSe:]ADEMod:FM:OFFSet?*, since, for determination of the frequency deviation, the modulation is removed by means of lowpass filtering, producing results that are different from those obtained by averaging with the *SENSe:...command*.

This command is only available for traces in the Result Display FM. If another result display is selected, the command is disabled.

Example:	"ADEM ON"	'Switches on FM demodulator
	"CALC:FEED 'XTIM:FM:TDOM"	'Switches on result display FM
	"CALC:MARK:FUNC:ADEM:FERR?"	'Queries the frequency error of trace 1

Characteristics: *RST value: -
SCPI: device-specific

Mode: FM

This command is only available with option R&S FS-K7 (FM Demodulator).

CALCulate<1|2>:MARKer<1...4>:FUNCTION:ADEMod:SINad:RESult<1...3>?

This command queries the result of the SINAD measurement. The numeric suffix (:RESult<1...3>) identifies the selected trace 1 to 3.

Example:	"ADEM ON"	'Switches on FM demodulator
	"CALC:FEED 'XTIM:FM:AFSP"	'Switches on AF spectrum of FM
	"DISP:TRAC ON"	'and trace
	"CALC:MARK:FUNC:ADEM:SIN:RES?"	'Queries SINAD value

Characteristics: *RST value: -
SCPI: device-specific

Mode: FM

This command is a query only and thus has no *RST value. This command is only available with option R&S FS-K7 (FM demodulator).

CALCulate<1|2>:MARKer<1...4>:FUNCTION:ADEMod:THD:RESult<1...3>?

This command queries the result of the THD measurement. The numeric suffix (:RESult<1...3>) marks the selected trace 1 to 3.

Example:

"ADEM ON"	'Switches on FM demodulator
"CALC:FEED XTIM:FM:AFSP"	'Switches on AF spectrum of FM
"DISP:TRAC ON"	'and trace
"CALC:MARK:FUNC:ADEM:THD:RES?"	'Queries THD result

Characteristics: *RST value: -
SCPI: device-specific

Mode: FM

This command is a query only and thus has no *RST value.

This command is only available with option R&S FS-K7 (FM demodulator).

CALCulate<1|2>:MARKer<1 to 4>:FUNCTION:ADEMod:CARRier[:RESult<1 to 3>]?

This command queries the carrier power.

With result display FM and SPECTRUM, the carrier power is determined from the current trace data (CLR/WRITE trace).

With result display RF Power, the carrier power is determined from trace 1 to 3 indicated in the numeric suffix.

Example:

"ADEM ON"	'Switches on FM demodulator
"CALC:FEED XTIM:RFP"	'Switches on result display RF POWER
"CALC:MARK:FUNC:ADEM:CARR?"	'Queries the carrier power

Characteristics: *RST value: -
SCPI: device-specific

Mode: FM

This command is only a query and therefore has no *RST value. It is only available with option R&S FS-K7 (FM demodulator).

CALCulate:MARKer:FUNCTION:POWER Subsystem

The CALCulate:MARKer:FUNCTION:POWER subsystem contains the commands for control of power measurement.

COMMAND	PARAMETERS	UNIT	COMMENT
CALCulate<1 2> :MARKer :FUNCTION :POWER :SElect :RESult? :PHZ :PRESet [:STATe]	ACPower CPower MCACpower OBANdwidth OBWidth CN CN0 ACPower CPower MCACpower OBANdwidth OBWidth CN CN0 <Boolean> <Boolean> NADC TETRA PDC PHS CDPD FWCDma RWCDma F8CDma R8CDma F19Cdma R19Cdma FW3Gppcdma RW3Gppcdma D2CDma S2CDma M2CDma FIS95A RIS95A FIS95C0 RIS95C0 FIS95C1 RIS95C1 FJ008 RJ008 TCDMa NONE OFF		query only no query

CALCulate<1|2>:MARKer<1...4>:FUNCTION:POWER:SElect ACPower | CPower | MCACpower | OBANdwidth | OBWidth | CN | CN0

This command selects – and switches on – one of the above types of power measurement in the selected measurement window. This function is independent of the selected marker, i.e. the numerical suffix <1...4> appended to MARKer has no effect.

The channel spacings and channel bandwidths are configured in the SENSE:POWER:ACHannel subsystem.

Please note the following:

If CPower is selected, the number of adjacent channels (command:

[SENSE:]POWER:ACHannel:ACPairs) is set to 0. If ACPower is selected, the number of adjacent channels is set to 1, unless adjacent-channel power measurement is switched on already.

With respect to the above two settings, the behaviour of the R&S ESCI from that of the R&S ESIB family.

Note: *The channel/adjacent-channel power measurement is performed for the trace selected with SENSE:POWER:TRACe 1|2|3.*

The occupied bandwidth measurement is performed for the trace on which marker 1 is positioned. To select another trace for the measurement, marker 1 is to be positioned on the desired trace by means of CALC:MARK:TRAC 1|2|3.

Parameters:

ACPower	Adjacent-channel power measurement with a single carrier signal
CPower	Channel power measurement with a single carrier signal (equivalent to adjacent-channel power measurement with <i>NO. OF ADJ CHAN = 0</i>)
MCACpower	Channel/adjacent-channel power measurement with several carrier signals
OBANdwidth OBWidth	Measurement of occupied bandwidth
CN	Measurement of carrier-to-noise ratio
CN0	Measurement of carrier-to-noise ratio referenced to 1 Hz bandwidth

Example: "CALC:MARK:FUNC:POW:SEL ACP" 'Switches on adjacent-channel power measurement in window A.

Characteristics: *RST value: -
SCPI: device-specific

Mode: A-F

The parameters CN and CN0 are available only from firmware version 1.40.

CALCulate<1|2>:MARKer<1...4>:FUNCTION:POWER:RESult? ACPower | CPOWer | MCACpower | OBANdwidth | OBWidth | CN | CN0

This command queries the result of the power measurement performed in the selected window. If necessary, the measurement is switched on prior to the query.

The channel spacings and channel bandwidths are configured in the `SENSe:POWer:ACHannel` subsystem.

To obtain a valid result, a complete sweep with synchronization to the end of the sweep must be performed before a query is output. Synchronization is possible only in the single-sweep mode.

Parameters:

ACPower: Adjacent-channel power measurement
Results are output in the following sequence, separated by commas:

1. Power of transmission channel
2. Power of lower adjacent channel
3. Power of upper adjacent channel
4. Power of lower alternate channel 1
5. Power of upper alternate channel 1
6. Power of lower alternate channel 2
7. Power of upper alternate channel 2

The number of measured values returned depends on the number of adjacent/alternate channels selected with `SENSe:POWer:ACHannel:ACPairs`.

With logarithmic scaling (`RANGE LOG`), the power is output in the currently selected level unit; with linear scaling (`RANGE LIN dB` or `LIN %`), the power is output in W. If `SENSe:POWer:ACHannel:MODE REL` is selected, the adjacent/alternate-channel power is output in dB.

CPOWer Channel power measurement

With logarithmic scaling (`RANGE LOG`), the channel power is output in the currently selected level unit; with linear scaling (`RANGE LIN dB` or `LIN %`), the channel power is output in W.

MCACpower: Channel/adjacent-channel power measurement with several carrier signals

Results are output in the following sequence, separated by commas:

1. Power of carrier signal 1
2. Power of carrier signal 2
3. Power of carrier signal 3
4. Power of carrier signal 4
5. Power of carrier signal 5
6. Power of carrier signal 6
7. Power of carrier signal 7
8. Power of carrier signal 8
9. Power of carrier signal 9
10. Power of carrier signal 10
11. Power of carrier signal 11
12. Power of carrier signal 12
13. Total power of all carrier signals
14. Power of lower adjacent channel
15. Power of upper adjacent channel

16. Power of lower alternate channel 1
17. Power of upper alternate channel 1
18. Power of lower alternate channel 2
19. Power of upper alternate channel 2

The number of measured values returned depends on the number of carrier signals and adjacent/alternate channels selected with `SENSe:POWer:ACHannel:TXChannel:COUNT` and `SENSe:POWer:ACHannel:ACPairs`.

If only one carrier signal is measured, the total value of all carrier signals will not be output.

With logarithmic scaling (`RANGE LOG`), the power is output in dBm; with linear scaling (`RANGE LIN dB` or `LIN %`), the power is output in W. If `SENSe:POWer:ACHannel:MODE REL` is selected, the adjacent/alternate-channel power is output in dB.

OBANdwidth OBWidth	Measurement of occupied bandwidth The occupied bandwidth in Hz is returned.
CN	Measurement of carrier-to-noise ratio The carrier-to-noise ratio in dB is returned.
CNO	Measurement of carrier-to-noise ratio referenced to 1 Hz bandwidth. The carrier-to-noise ratio in dB/Hz is returned.

Example of channel/adjacent-channel power measurement:

<code>"SENS2:POW:ACH:ACP 3"</code>	'Sets the number of adjacent/alternate channels in screen B to 3.
<code>"SENS2:POW:ACH:BAND 30KHZ"</code>	'Sets the bandwidth of the transmission channel to 30 kHz.
<code>"SENS2:POW:ACH:BAND:ACH 40KHZ"</code>	'Sets the bandwidth of each adjacent channel to 40 kHz.
<code>"SENS2:POW:ACH:BAND:ALT1 50KHZ"</code>	'Sets the bandwidth of each alternate channel to 50 kHz.
<code>"SENS2:POW:ACH:BAND:ALT2 60KHZ"</code>	'Sets the bandwidth of alternate channel 2 to 60 kHz.
<code>"SENS2:POW:ACH:SPAC 30KHZ"</code>	'Sets the spacing between the transmission channel and the adjacent channel to 30 kHz, the spacing between the transmission channel and alternate channel 1 to 60 kHz, and the spacing between the transmission channel and alternate channel 2 to 90 kHz.
<code>"SENS2:POW:ACH:SPAC:ALT1 100KHZ"</code>	'Sets the spacing between the transmission channel and alternate channel 1 to 100 kHz, and the spacing between the transmission channel and alternate channel 2 to 150 kHz.
<code>"SENS2:POW:ACH:SPAC:ALT2 140KHZ"</code>	'Sets the spacing between the transmission channel and alternate channel 2 to 140 kHz.
<code>"SENS2:POW:ACH:MODE ABS"</code>	'Switches on absolute power measurement.
<code>"CALC2:MARK:FUNC:POW:SEL ACP"</code>	'Switches on the adjacent-channel power measurement in screen B.
<code>"INIT:CONT OFF"</code>	'Switches over to single-sweep mode.
<code>"INIT;*WAI"</code>	'Starts a sweep and waits for the end of the sweep.
<code>"CALC2:MARK:FUNC:POW:RES? ACP"</code>	'Queries the result of adjacent-channel power measurement in screen B.
<code>"SENS2:POW:ACH:REF:AUTO ONCE"</code>	'Defines the measured channel power as the reference value for relative power measurements.

If the **channel power only** is to be measured, all commands relating to adjacent/alternate channel bandwidth and channel spacings are omitted. The number of adjacent/alternate channels is set to 0 with `SENS2:POW:ACH:ACP 0`.

Example of occupied bandwidth measurement:

<code>"SENS2:POW:BAND 90PCT"</code>	'	Defines 90% as the percentage of the power to be contained in the bandwidth range to be measured.
<code>"INIT:CONT OFF"</code>	'	Switches over to single-sweep mode.
<code>"INIT;*WAI"</code>	'	Starts a sweep and waits for the end of the sweep.
<code>"CALC2:MARK:FUNC:POW:RES? OBW"</code>	'	Queries the occupied bandwidth measured in screen B.

Characteristics: *RST value: -
SCPI: device-specific

Mode: A-F

This command is a query and therefore has no *RST value.

CALCulate<1|2>:MARKer<1 to 4>:FUNCtion:POWer:RESult:PHZ ON | OFF

This command switches the query response of the power measurement results in the indicated measurement window between output of absolute values (OFF) and output referred to the measurement bandwidth (ON).

The measurement results are output with `CALCulate:MARKer:FUNCtion:POWer:RESult?`

Parameter:

ON: Results output referred to measurement bandwidth.

OFF: Results output in absolute values.

Example of channel/adjacent channel measurement:

<code>"SENS2:POW:ACH:ACP 3"</code>	'	Sets the number of adjacent channels in 'screen B to 3.
<code>"SENS2:POW:ACH:BAND 30KHZ"</code>	'	Sets the bandwidth of the main channel to 30 kHz.
<code>"SENS2:POW:ACH:BAND:ACH 40KHZ"</code>	'	Sets the bandwidth of all adjacent 'channels to 40 kHz.
<code>"SENS2:POW:ACH:BAND:ALT1 50KHZ"</code>	'	Sets the bandwidth of all alternate 'adjacent channels to 50 kHz.
<code>"SENS2:POW:ACH:BAND:ALT2 60KHZ"</code>	'	Sets the bandwidth of alternate adjacent 'channel 2 to 60 kHz.
<code>"SENS2:POW:ACH:SPAC 30KHZ"</code>	'	Sets the spacing between channel and 'adjacent channel as well as between all 'adjacent channels to 30 kHz.
<code>"SENS2:POW:ACH:SPAC:ALT1 40KHZ"</code>	'	Sets the spacing between adjacent 'channel and alternate adjacent channel as 'well as between all alternate adjacent 'channels to 40 kHz.
<code>"SENS2:POW:ACH:SPAC:ALT2 50KHZ"</code>	'	Sets the spacing between alternate 'adjacent channel 1 and alternate adjacent 'channel 2 to 50 kHz.
<code>"SENS2:POW:ACH:MODE ABS"</code>	'	Switches on absolute power 'measurement.
<code>"CALC2:MARK:FUNC:POW:SEL ACP"</code>	'	Switches the adjacent channel power 'measurement in screen B.
<code>"INIT:CONT OFF"</code>	'	Switches to single-sweep mode.
<code>"INIT;*WAI"</code>	'	Starts a sweep and waits for the end.

"CALC2:MARK:FUNC:POW:RES:PHZ ON" 'Output of results referred to the channel
'bandwidth.
 "CALC2:MARK:FUNC:POW:RES? ACP" 'Queries the result of the adjacent channel
'power measurement in screen B referred
'to the channel bandwidth.

If only the **channel power** is to be measured, all commands for defining the bandwidths of adjacent channels as well as the channel spacings are not necessary. The number of adjacent channels is set to 0 with SENS2:POW:ACH:ACP 0.

Characteristics: *RST value: -
 SCPI: device-specific
Mode: A-F

CALCulate<1|2>:MARKer<1 to 4>:FUNCtion:POWER[:STATe] OFF

This command switches off the power measurement in the selected measurement window.

Example: "CALC:MARK:FUNC:POW OFF" 'Switches off the power measurement in screen B.

Characteristics: *RST value: -
 SCPI: device-specific
Mode: A-F

This command is an event and therefore has no *RST value.

CALCulate<1|2>:MARKer<1 to 4>:FUNCtion:POWER:PRESet

NADC | TETRA | PDC | PHS | CDPD | FWCDma | RWCDma | F8CDma | R8CDma | F19Cdma | R19Cdma | FW3Gppcdma | RW3Gppcdma | D2CDma | S2CDma | M2CDma | FIS95A | RIS95A | FIS95C0 | RIS95C0 | FJ008 | RJ008 | FIS95C1 | RIS95C1 | TCDMa | NONE

This command selects the power measurement setting for a standard in the indicated measurement window and previously switches on the corresponding measurement, if required. The function is independent of the marker selection, i.e. the numeric suffix <1 to 4> of MARKer is irrelevant.

The configuration for a standard comprises of the parameters weighting filter, channel bandwidth and spacing, resolution and video bandwidth, as well as detector and sweep time.

Meaning of the CDMA standard abbreviations:

FIS95A, F8CDma	CDMA IS95A forward	RIS95A, R8CDma	CDMA IS95A reverse
FJ008, F19CDma	CDMA J-STD008 forward	RJ008, R19CDma	CDMA J-STD008 reverse
FIS95C0	CDMA IS95C Class 0 forward	RIS95C0	CDMA IS95C Class 0 reverse
FIS95C1	CDMA IS95C Class 1 forward	RIS95C1	CDMA IS95C Class 1 reverse
FWCDma	W-CDMA 4.096 MHz forward	RWCDma	W-CDMA 4.096 MHz reverse
FW3Gppcdma	W-CDMA 3.84 MHz forward	RW3Gppcdma	W-CDMA 3.84 MHz reverse
D2CDma	CDMA 2000 direct sequence	S2CDma	CDMA 2000 MC1 multi carrier with 1 carrier
M2CDma	CDMA 2000 MC3 multi carrier with 3 carriers	TCDMa	TD-SCDMA

Notes: The settings for standards IS95A and C differ as far as the calculation method of channel spacings is concerned. For IS95A and J-STD008 the spacing is calculated from the center of the main channel to the center of the corresponding adjacent channel, for IS95C from the center of the main channel to the nearest border of the adjacent channel.

Example: "CALC2:MARK:FUNC:POW:PRESet NADC" 'Selects the standard setting for
'NADC in screen B

Characteristics: *RST value: -
 SCPI: device-specific
Mode: A-F

CALCulate:MARKer:FUNCTION:STRack Subsystem

The CALCulate:MARKer:FUNCTION:STRack subsystem defines the settings of the signal track.

COMMAND	PARAMETERS	UNIT	COMMENT
CALCulate<1 2> :MARKer :FUNCTION :STRack [:STATe] :BANDwidth :BWIDth :THReshold :TRACe	<Boolean> <numeric_value> <numeric_value> <numeric_value> <numeric_value>	 HZ HZ DBM	

CALCulate<1|2>:MARKer<1 to 4>:FUNCTION:STRack[:STATe] ON | OFF

This command switches the signal-track function on or off for the the selected measurement window. The function is independent of the selected marker, i.e. the numeric suffix <1 to 4> of MARKer is irrelevant.

With signal track activated, the maximum signal is determined after each frequency sweep and the center frequency is set to the frequency of this signal. Thus with drifting signals the center frequency follows the signal.

Example: "CALC:MARK:FUNC:STR ON" 'Switches on the signal track function for 'screen A.

Characteristics: *RST value: OFF
SCPI: device-specific

Mode: A-F

CALCulate<1|2>:MARKer<1 to 4>:FUNCTION:STRack:BANDwidth 10Hz to MAX(SPAN)

CALCulate<1|2>:MARKer<1 to 4>:FUNCTION:STRack:BWIDth 10Hz to MAX(SPAN)

These commands have the same function. For the selected measurement window they define the bandwidth around the center frequency within which the largest signal is searched. The function is independent of the selected marker, i.e. the numeric suffix <1 to 4> of MARKer is irrelevant. It is only available in the frequency domain (span > 0).

Note: The entry of the search bandwidth is only possible if the Signal Track function is switched on (CALC:MARK:FUNC:STR ON).

Example: "CALC:MARK:FUNC:STR:BAND 1MHZ" 'Sets the search bandwidth for screen 'A to 1 MHz.

"CALC:MARK:FUNC:STR:BWID 1MHZ" 'Alternative command for the same 'function.

Characteristics: *RST value: -- (= span/10 on activating the function)
SCPI: device-specific

Mode: A-F

CALCulate<1|2>:MARKer<1 to 4>:FUNCtion:STRack:THReshold -330dBm to +30dBm

This command defines the threshold above which the largest signal is searched for in the selected measurement window. The function is independent of the selected marker, i.e. the numeric suffix <1 to 4> of MARKer is irrelevant. It is only available in the frequency domain (span > 0)..

The response unit depends on the settings defined with CALC:UNIT.

Note: *The entry of the search bandwidth is only possible if the Signal Track function is switched on (CALC:MARK:FUNC:STR ON).*

Example: "CALC:MARK:FUNC:STR:THR -50DBM" 'Sets the threshold for signal tracking
'in screen A to -50 dBm.

Characteristics: *RST value: -120 dBm
SCPI: device-specific

Mode: A-F

CALCulate<1|2>:MARKer<1 to 4>:FUNCtion:STRack:TRACe 1 to 3

This command defines the trace on which the largest signal is searched for in the selected measurement window. The function is independent of the selected marker, i.e. the numeric suffix <1 to 4> of MARKer is irrelevant. It is only available in the frequency domain (span > 0).

Example: "CALC2:MARK:FUNC:STR:TRAC 3" 'Defines trace 3 in screen B as the
'trace for signal tracking.

Characteristics: *RST value: 1
SCPI: device-specific

Mode: A-F

CALCulate<1|2>:MARKer<1 to 4>:FUNCtion:SUMMery[:STATe] ON | OFF

This command switches on or off the previously selected time domain power measurements. Thus one or several measurements can be first selected and then switched on and off together with `CALC:MARK:FUNC:SUMMery:STATe`.

The function is independent of the marker selection, i.e. the suffix of MARKer is irrelevant. It is only available in the time domain (span = 0).

Example: `"CALC:MARK:FUNC:SUMM:STAT ON"`

Characteristics: *RST value: OFF
SCPI: device-specific

Mode: A-T

CALCulate<1|2>:MARKer<1 to 4>:FUNCtion:SUMMery:PPEak[:STATe] ON | OFF

This command switches on or off the measurement of the positive peak value in the selected measurement window.

The function is independent of the marker selection, i.e. the numeric suffix <1 to 4> of MARKer is irrelevant. It is only available in the time domain (span = 0).

Example: `"CALC:MARK:FUNC:SUMM:PPE ON"` 'Switches on the function in screen A.

Characteristics: *RST value: OFF
SCPI: device-specific

Mode: A-T

CALCulate<1|2>:MARKer<1 to 4>:FUNCtion:SUMMery:PPEak:RESult?

This command is used to query the result of the measurement of the positive peak value in the selected measurement window. The measurement may have to be switched on previously.

The function is independent of the marker selection, i.e. the numeric suffix <1 to 4> of MARKer is irrelevant. It is only available in the time domain (span = 0).

A complete sweep with synchronization to sweep end must be performed between switching on the function and querying the measured value to obtain a valid query result. This is only possible in single sweep mode.

Example: `"INIT:CONT OFF"` 'Switches to single-sweep mode.
`"CALC:MARK:FUNC:SUMM:PPE ON"` 'Switches on the function in screen A.
`"INIT;*WAI"` 'Starts a sweep and waits for the end.
`"CALC:MARK:FUNC:SUMM:PPE:RES?"` 'Outputs the result of screen A.

Characteristics: *RST value: -
SCPI: device-specific

Mode: A-T

This command is only a query and therefore has no *RST value.

CALCulate<1|2>:MARKer<1 to 4>:FUNction:SUMMary:PPEak:AVERage:RESult?

This command is used to query the result of the measurement of the averaged positive peak value in the selected measurement window. The query is only possible if averaging has been activated previously using CALCulate<1|2>:MARKer<1 to 4>:FUNction:SUMMary:AVERage.

The function is independent of the marker selection, i.e. the numeric suffix <1 to 4> in MARKer is irrelevant. It is only available in the time domain (span = 0).

A complete sweep with synchronization to sweep end must be performed between switching on the function and querying the measured value to obtain a valid query result. This is only possible in single sweep mode.

Example:

"INIT:CONT OFF"	'Switches to single-sweep mode.
"CALC:MARK:FUNC:SUMM:PPE ON"	'Switches on the function in screen A.
"CALC:MARK:FUNC:SUMM:AVER ON"	'Switches on the calculation of average in screen A.
"INIT;*WAI"	'Starts a sweep and waits for the end.
"CALC:MARK:FUNC:SUMM:PPE:AVER:RES?"	'Outputs the result of screen A.

Characteristics: *RST value: -
SCPI: device-specific

Mode: A-T

This command is only a query and therefore has no *RST value.

CALCulate<1|2>:MARKer<1 to 4>:FUNction:SUMMary:PPEak:PHOLd:RESult?

This command is used to query the result of the measurement of the positive peak value with active peak hold function. The query is only possible if the peak hold function has been activated previously using CALCulate<1|2>:MARKer<1 to 4>:FUNction:SUMMary:PHOLd.

The function is independent of the marker selection, i.e. the numeric suffix <1 to 4> of :MARKer is irrelevant. It is only available in the time domain (span = 0).

A complete sweep with synchronization to sweep end must be performed between switching on the function and querying the measured value to obtain a valid query result. This is only possible in single sweep mode.

Example:

"INIT:CONT OFF"	'Switches to single-sweep mode.
"CALC:MARK:FUNC:SUMM:PPE ON"	'Switches on the function in screen A.
"CALC:MARK:FUNC:SUMM:PHOL ON"	'Switches on the measurement of the peak value in screen A.
"INIT;*WAI"	'Starts a sweep and waits for the end.
"CALC:MARK:FUNC:SUMM:PPE:PHOL:RES?"	'Outputs the result of screen A.

Characteristics: *RST value: -
SCPI: device-specific

Mode: A-T

This command is only a query and therefore has no *RST value.

CALCulate<1|2>:MARKer<1 to 4>:FUNCTION:SUMMARY:RMS[:STATe] ON | OFF

This command switches on or off the measurement of the effective (RMS) power in the selected measurement window. If necessary the function is switched on previously.

The function is independent of the marker selection, i.e. the numeric suffix <1 to 4> of :MARKer is irrelevant. It is only available in the time domain (span = 0).

Example: "CALC2:MARK:FUNC:SUM:RMS ON" 'Switches on the function in screen B.

Characteristics: *RST value: OFF
SCPI: device-specific

Mode: A-T

CALCulate<1|2>:MARKer<1 to 4>:FUNCTION:SUMMARY:RMS:RESult?

This command queries the result of the measurement of the RMS power value in the selected measurement window.

The function is independent of the marker selection, i.e. the numeric suffix <1 to 4> of :MARKer is irrelevant. It is only available in the time domain (span = 0).

A complete sweep with synchronization to sweep end must be performed between switching on the function and querying the measured value to obtain a valid query result. This is only possible in single sweep mode.

Example: "INIT:CONT OFF" 'Switches to single-sweep mode.
"CALC:MARK:FUNC:SUMM:RMS ON" 'Switches on the function in screen A.
"INIT;*WAI" 'Starts a sweep and waits for the end.
"CALC:MARK:FUNC:SUMM:RMS:RES?" 'Outputs the result of screen A.

Characteristics: *RST- value: -
SCPI: device-specific

Mode: A-T

This command is only a query and therefore has no *RST value.

CALCulate<1|2>:MARKer<1 to 4>:FUNCTION:SUMMARY:RMS:AVERAGE:RESult?

This command queries the result of the measurement of the averaged RMS value in the selected measurement window. The query is only possible if averaging has been activated previously using CALCulate<1|2>:MARKer<1 to 4>:FUNCTION:SUMMARY:AVERAGE.

The function is independent of the marker selection, i.e. the numeric suffix <1 to 4> of :MARKer is irrelevant. It is only available in the time domain (span = 0).

A complete sweep with synchronization to sweep end must be performed between switching on the function and querying the measured value to obtain a valid query result. This is only possible in single sweep mode.

Example: "INIT:CONT OFF" 'Switches to single-sweep mode.
"CALC:MARK:FUNC:SUMM:RMS ON" 'Switches on the function in screen A.
"CALC:MARK:FUNC:SUMM:AVER ON" 'Switches on the average value
'calculation in screen A.
"INIT;*WAI" 'Starts a sweep and waits for the end.
"CALC:MARK:FUNC:SUMM:RMS:AVER:RES?" 'Outputs the result of screen A.

Characteristics: *RST- value: -
SCPI: device-specific

Mode: A-T

This command is only a query and therefore has no *RST value.

CALCulate<1|2>:MARKer<1 to 4>:FUNction:SUMMery:RMS:PHOLd:RESult?

This command queries the result of the measurement of the RMS value with active peak hold in the selected measurement window. The query is only possible only if the peak hold function has been activated previously using CALCulate<1|2>:MARKer<1 to 4>: FUNction:SUMMery:PHOLd. The function is independent of the marker selection, i.e. the numeric suffix <1 to 4> of :MARKer is irrelevant. It is only available in the time domain (span = 0).

A complete sweep with synchronization to sweep end must be performed between switching on the function and querying the measured value to obtain a valid query result. This is only possible in single sweep mode.

Example:

```
"INIT:CONT OFF"           'Switches to single-sweep mode.
"CALC:MARK:FUNC:SUMM:RMS ON" 'Switches on the function in screen A.
"CALC:MARK:FUNC:SUMM:PHOL ON" 'Switches on the peak value
                               'measurement in screen A.
"INIT;*WAI"               'Starts a sweep and waits for the end.
"CALC:MARK:FUNC:SUMM:RMS:PHOL:RES?" 'Outputs the result of screen A.
```

Characteristics: *RST- value: -
SCPI: device-specific

Mode: A-T

This command is only a query and therefore has no *RST value.

CALCulate<1|2>:MARKer<1 to 4>:FUNction:SUMMery:MEAN[:STATe] ON | OFF

This command switches on or off the measurement of the mean value in the selected measurement window.

The function is independent of the marker selection, i.e. the numeric suffix <1 to 4> of :MARKer is irrelevant. It is only available in the time domain (span = 0)..

Note: *The measurement is performed on the trace on which marker 1 is positioned. In order to evaluate another trace, marker 1 must be positioned on another trace with CALC:MARK:TRAC 1|2|3.*

Example: "CALC:MARK:FUNC:SUMM:MEAN ON" 'Switches on the function in screen A.

Characteristics: *RST value: OFF
SCPI: device-specific

Mode: A-T

CALCulate<1|2>:MARKer<1 to 4>:FUNction:SUMMery:MEAN:RESult?

This command queries the result of the measurement of the mean value in the selected measurement window. The function is independent of the marker selection, i.e. the numeric suffix <1 to 4> of :MARKer is irrelevant. It is only available in the time domain (span = 0).

A complete sweep with synchronization to sweep end must be performed between switching on the function and querying the measured value to obtain a valid query result. This is only possible in single sweep mode.

Example:

```
"INIT:CONT OFF"           'Switches to single-sweep mode.
"CALC:MARK:FUNC:SUMM:MEAN ON" 'Switches on the function in screen A.
"INIT;*WAI"               'Starts a sweep and waits for the end.
"CALC:MARK:FUNC:SUMM:MEAN:RES?" 'Outputs the result of screen A.
```

Characteristics: *RST- value: -
SCPI: device-specific

Mode: A-T

This command is only a query and therefore has no *RST value.

CALCulate<1|2>:MARKer<1 to 4>:FUNction:SUMMary:MEAN:AVERage:RESult?

This command queries the result of the measurement of the averaged mean value in the selected measurement window. The query is only possible if averaging has been activated previously using CALCulate<1|2>:MARKer<1 to 4>:FUNction: SUMMary:AVERage.

The function is independent of the marker selection, i.e. the numeric suffix <1 to 4> of :MARKer is irrelevant. It is only available in the time domain (span = 0).

A complete sweep with synchronization to sweep end must be performed between switching on the function and querying the measured value to obtain a valid query result. This is only possible in single sweep mode.

Example:

"INIT:CONT OFF"	'Switches to single-sweep mode.
"CALC:MARK:FUNC:SUMM:MEAN ON"	'Switches on the function in screen A.
"CALC:MARK:FUNC:SUMM:AVER ON"	'Switches on the average value calculation in screen A.
"INIT;*WAI"	'Starts a sweep and waits for the end.
"CALC:MARK:FUNC:SUMM:MEAN:AVER:RES?"	'Outputs the result of screen A.

Characteristics: *RST- value: -
SCPI: device-specific

Mode: A-T

This command is only a query and therefore has no *RST value.

CALCulate<1|2>:MARKer<1 to 4>:FUNction:SUMMary:MEAN:PHOLd:RESult?

This command queries the result of the measurement of the mean value with active peak hold in the selected measurement window. The query is only possible if the peak hold function has been switched on previously using CALCulate<1|2>:MARKer<1 to 4>:FUNction:SUMMary:PHOLd.

The query is possible only if the peak hold function is active. The function is independent of the marker selection, i.e. the numeric suffix <1 to 4> of :MARKer is irrelevant. It is only available in the time domain (span = 0).

A complete sweep with synchronization to sweep end must be performed between switching on the function and querying the measured value to obtain a valid query result. This is only possible in single sweep mode.

Example:

"INIT:CONT OFF"	'Switches to single-sweep mode
"CALC:MARK:FUNC:SUMM:MEAN ON"	'Switches on the function in screen A
"CALC:MARK:FUNC:SUMM:PHOL ON"	'Switches on the peak value measurement in screen A
"INIT;*WAI"	'Starts a sweep and waits for the end
"CALC:MARK:FUNC:SUMM:MEAN:PHOL:RES?"	'Outputs the result of screen A.

Characteristics: *RST- value: -
SCPI: device-specific

Mode: A-T

This command is only a query and therefore has no *RST value.

CALCulate<1|2>:MARKer<1 to 4>:FUNCTION:SUMMARY:SDEVIation[:STATe] ON | OFF

This command switches on or off the measurement of the standard deviation in the selected measurement window. The function is independent of the marker selection, i.e. the numeric suffix <1 to 4> of :MARKer is irrelevant. It is only available in the time domain (span = 0)..

On switching on the measurement, the mean power measurement is switched on as well.

Example: "CALC2:MARK:FUNC:SUMM:SDEV ON" 'Switches on the measurement of
'the standard deviation in screen B.

Characteristics: *RST value: OFF
SCPI: device-specific

Mode: A

CALCulate<1|2>:MARKer<1 to 4>:FUNCTION:SUMMARY:SDEVIation:RESult?

This command queries the results of the standard deviation measurement. The function is independent of the marker selection, i.e. the numeric suffix <1 to 4> of :MARKer is irrelevant. It is only available in the time domain (span = 0).

A complete sweep with synchronization to sweep end must be performed between switching on the function and querying the measured value to obtain a valid query result. This is only possible in single sweep mode.

Example: "INIT:CONT OFF" 'Switches to single-sweep mode.
"CALC:MARK:FUNC:SUMM:SDEV ON" 'Switches on the function in screen A.
"INIT;*WAI" 'Starts a sweep and waits for the end.
"CALC:MARK:FUNC:SUMM:SDEV:RES?" 'Outputs the result of screen A.

Characteristics: *RST value: -
SCPI: device-specific

Mode: A-T

This command is only a query and therefore has no *RST value.

CALCulate<1|2>:MARKer<1 to 4>:FUNCTION:SUMMARY:SDEVIation:AVERAge:RESult?

This command queries the result of the averaged standard deviation determined in several sweeps in the selected measurement window. The query is possible only if averaging is active. The function is independent of the marker selection, i.e. the numeric suffix <1 to 4> of :MARKer is irrelevant. It is only available in the time domain (span = 0).

A complete sweep with synchronization to sweep end must be performed between switching on the function and querying the measured value to obtain a valid query result. This is only possible in single sweep mode.

Example: "INIT:CONT OFF" 'Switches to single-sweep mode.
"CALC:MARK:FUNC:SUMM:SDEV ON" 'Switches on the function in screen A.
"CALC:MARK:FUNC:SUMM:AVER ON" 'Switches on the calculation of average
'in screen A.
"INIT;*WAI" 'Starts a sweep and waits for the end.
"CALC:MARK:FUNC:SUMM:MEAN:SDEV:RES?" 'Outputs the result of screen A.

Characteristics: *RST value: -
SCPI: device-specific

Mode: A-T

This command is only a query and therefore has no *RST value.

CALCulate<1|2>:MARKer<1 to 4>:FUNCTION:SUMMARY:SDEVIation:PHOLd:RESult?

This command queries the maximum standard deviation value determined in several sweeps in the selected measurement window. The query is possible only if the peak hold function is active.

The function is independent of the marker selection, i.e. the numeric suffix <1 to 4> of :MARKer is irrelevant. It is only available in the time domain (span = 0).

A complete sweep with synchronization to sweep end must be performed between switching on the function and querying the measured value to obtain a valid query result. This is only possible in single sweep mode.

Example:

"INIT:CONT OFF"	'Switches to single-sweep mode.
"CALC:MARK:FUNC:SUMM:SDEV ON"	'Switches on the function in screen A.
"CALC:MARK:FUNC:SUMM:PHOL ON"	'Switches on the peak value measurement in screen A.
"INIT;*WAI"	'Starts a sweep and waits for the end.
"CALC:MARK:FUNC:SUMM:SDEV:PHOL:RES?"	'Outputs the result of screen A.

Characteristics: *RST value: -
SCPI: device-specific

Mode: A-T

This command is only a query and therefore has no *RST value.

CALCulate<1|2>:MARKer<1 to 4>:FUNCTION:SUMMARY:PHOLd ON | OFF

This command switches on or off the peak-hold function for the active time domain power measurement in the indicated measurement window. The function is independent of the marker selection, i.e. the numeric suffix <1 to 4> of :MARKer is irrelevant. It is only available in the time domain (span = 0).

The peak-hold function is reset by switching it off and on again.

Example: "CALC:MARK:FUNC:SUMM:PHOL ON" 'Switches on the function in screen A.

Characteristics: *RST value: OFF
SCPI: device-specific

Mode: A-T

The peak-hold function is reset by switching off and on, again.

CALCulate<1|2>:MARKer<1 to 4>:FUNCTION:SUMMARY:AVERAge ON | OFF

This command switches on or off averaging for the active time domain power measurement in the indicated window. The function is independent of the marker selection, i.e. the numeric suffix <1 to 4> of :MARKer is irrelevant. It is only available in the time domain (span = 0).

Averaging is reset by switching it off and on again.

The number of results required for the calculation of average is defined with
[SENSE<1|2>:]AVERAge:COUNT.

It should be noted that synchronization to the end of averaging is only possible in single sweep mode.

Example:

"INIT:CONT OFF"	'Switches to single-sweep mode.
"CALC2:MARK:FUNC:SUMM:AVER ON"	'Switches on the calculation of average in screen B.
"AVER:COUN 200"	'Sets the measurement counter to 200.
"INIT;*WAI"	'Starts a sweep and waits for the end.

Characteristics: *RST value: OFF
SCPI: device-specific

Mode: A-T

CALCulate<1|2>:MARKer<1 to 4>:FUNCtion:SUMMary:MODE ABSolute | RELative

This command selects absolute or relative time domain power measurement in the indicated measurement window. The function is independent of the marker selection, i.e. the numeric suffix <1 to 4> of :MARKer is irrelevant. It is only available in the time domain (span = 0).

The reference power for relative measurement is defined with CALCulate:MARKer:FUNCtion:SUMMary:REFerence:AUTO ONCE. If the reference power is not defined, the value 0 dBm is used.

Example: "CALC:MARK:FUNC:SUMM:MODE REL"
' Switches the time domain power
'measurement to relative.

Characteristics: *RST value: ABSolute
SCPI: device-specific

Mode: A-T

CALCulate<1|2>:MARKer<1 to 4>:FUNCtion:SUMMary:REFerence:AUTO ONCE

With this command the currently measured average value (. . :SUMMary:MEAN) and RMS value (. . :SUMMary:RMS) are declared as reference values for relative measurements in the indicated measurement window. The function is independent of the marker selection, i.e. the numeric suffix <1 to 4> of :MARKer is irrelevant. It is only available in the time domain (span = 0).

If the measurement of RMS value and average is not activated, the reference value 0 dBm is used.

If the function . . . :SUMMary:AVERage or . . . :SUMMary:PHOLd is switched on, the current value is the accumulated measurement value at the time considered.

Example: "CALC:MARK:FUNC:SUMM:REF:AUTO ONCE"
' Takes the currently measured power in
'screen A as reference value for the relative
'time domain power measurement.

Characteristics: *RST value: -
SCPI: device-specific

Mode: A-T

This command is an event and therefore has no *RST value and no query.

CALCulate<1|2>:MARKer<1 to 4>:FUNCtion:SUMMary:AOFF

This command switches off all time domain measurements in the selected measurement window. The function is independent of the marker selection, i.e. the numeric suffix <1 to 4> of :MARKer is irrelevant. It is only available in the time domain (span = 0).

Example: "CALC2:MARK:FUNC:SUMM:AOFF"
'Switches off the time domain power
'measurement functions in screen B.

Characteristics: *RST value: -
SCPI: device-specific

Mode: A-T

This command is an event and therefore has no *RST value and no query.

CALCulate<1|2>:MARKer<1 to 4>:FUNCtion:MSUMmary? <time offset of first pulse>, <measurement time>, <period>, < # of pulses to measure>

The commands of this subsystem are used to determine the power of a sequence of signal pulses having the same interval, as are typical for the slots of a GSM signal, for example. The number of pulses to be measured as well as the measurement time and the period can be set. To define the position of the first pulse in the trace, a suitable offset can be entered.

The evaluation is performed on the measurement data of a previously recorded trace. The data recorded during the set measurement time is combined to a measured value for each pulse according to the detector specified and the indicated number of results is output as a list.

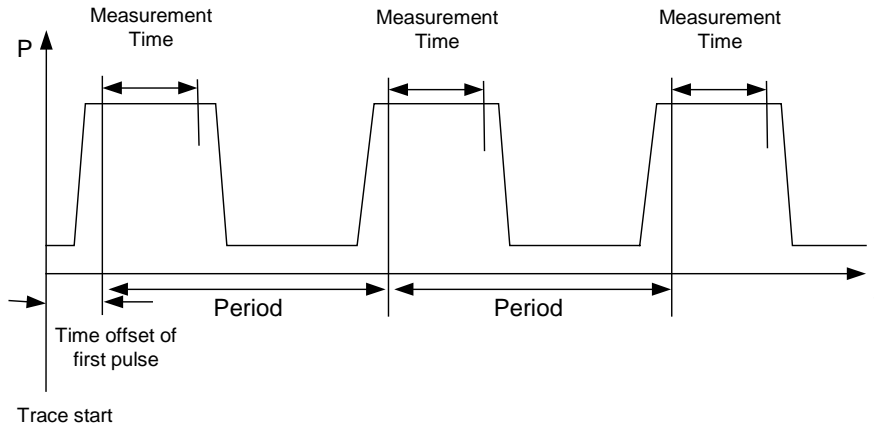

TRACE 1 of the selected screen is always used by the function. The suffix of MARKer will be ignored.

Example:	"DISP:WIND:TRAC:Y:RLEV -10dBm"	'Sets the reference level to 10 dB
	"INP:ATT 30 dB"	'Sets the input attenuation to 30 dB
	"FREQ:CENT 935.2MHz;SPAN 0Hz"	'Sets the receive frequency to 935.2 MHz and the span to 0 Hz
	"BAND:RES 1MHz;VID 3MHz"	'Sets the resolution bandwidth to 1 MHz and the video bandwidth to 3 MHz
	"DET RMS"	'Sets the RMS detector
	"TRIG:SOUR VID;LEV:VID 50 PCT"	'Selects the trigger source VIDEo and sets the level of the video trigger source to 50 PCT
	"SWE:TIME 50ms"	'Sets the sweep time to 50 ms
	"INIT;*WAI"	'Starts the measurement with synchronization
	"CALC:MARK:FUNC:MSUM? 50US,450US,576.9US,8"	'Queries 8 bursts with an offset of 50 μ s, a test time of 450 μ s and a period of 576.9 μ s

Characteristics:

*RST value:-
SCPI:device-specific

Mode:

A-Z

CALCulate:MATH Subsystem

The CALCulate:MATH subsystem allows to process data from the SENSE-subsystem in numeric expressions. The measurement windows are selected by CALCulate1 (screen A) or CALCulate2 (screen B).

COMMAND	PARAMETERS	UNIT	COMMENT
CALCulate<1 2> :MATH [:EXPRession] [:DEFine] :POSition :STATe :MODE	<expr> <numeric_value> <Boolean> LINear LOGarithmic	-- PCT -- --	

CALCulate<1|2>:MATH[:EXPRession][:DEFine] <expr>

This command defines the mathematical expression for relating traces to trace1.

The zero point of the result display can be defined with CALC:MATH:POS. Command CALCulate:MATH:STATe switches the mathematical relation of traces on or off.

Parameter: <expr> ::= 'OP1 - OP2'
 OP1 ::= TRACE1
 OP2 ::= TRACE2 | TRACE3

Example: "CALC1:MATH (TRACE1 - TRACE2)" 'Selects the subtraction of trace 1
 'from trace 2 in screen A.
 "CALC2:MATH (TRACE1 - TRACE3)" 'Selects the subtraction of trace 1
 'from trace 3 in screen B.

Characteristics: *RST value: -
 SCPI: conforming

Mode: R, A

CALCulate<1|2>:MATH:POSition -100PCT to 200PCT

This command defines the position of the result of the trace mathematics in the selected measurement window. The indication is in % of the screen height, with 100% corresponding to the upper diagram border.

Example: "CALC:MATH:POS 50PCT" 'Sets the position in screen A to the
 'horizontal diagram center.

Characteristics: *RST value: 50 %
 SCPI: device-specific

Mode: A

CALCulate<1|2>:MATH:STATe ON | OFF

This command switches the mathematical relation of traces on or off.

Example: "CALC:MATH:STAT ON" 'Switches on the trace mathematics in 'screen A.

Characteristics: *RST value: OFF
SCPI: conforming

Mode: R, A

CALCulate<1|2>:MATH:MODE LINear | LOGarithmic

This command selects linear or logarithmic (= video) calculation of the mathematical functions related to the traces. The calculation of the average is one of the affected functions. The setting is valid for all measurement windows, i.e. the numeric suffix <1|2> of CALCulate is irrelevant.

Example: "CALC:MATH:MODE LIN" 'Switches on the linear calculation.

Characteristics: *RST value: LOG
SCPI: device-specific

Mode: A

CALCulate:PEAKsearch|PSEarch Subsystem

The CALCulate:PEAKsearch subsystem contains commands for the final measurement of scan results in the test receiver mode.

Command	PARAMETER	Unit	Comment
CALCulate<1 2>			
:PEAKsearch			
[:IMMEDIATE]			
:MARGIN	<numeric_value>	dB	
:SUBRANGES	<numeric_value>	--	
:METHOD	SUBRANGE PEAK		
:PSEARCH			
[:IMMEDIATE]			
:MARGIN	<numeric_value>	dB	
:SUBRANGES	<numeric_value>	--	
:METHOD	SUBRANGE PEAK		

:CALCulate<1|2>:PEAKsearch|PSEarch[:IMMEDIATE]

This command generates a peak list from the scan results. For this purpose, a scan must be performed prior to the command. The numeric suffix under CALCulate<1|2> is irrelevant.

Example: " :CALC:PEAK "

Characteristics: *RST value: -
SCPI: device specific

Mode: R

This command is an event and therefore has no *RST value and no query.

:CALCulate<1|2>:PEAKsearch|PSEarch:MARGIN MINimum .. MAXimum

This command determines the margin (distance to the limit line) for generating the peak list. This parameter is not used unless a limit line has been assigned to the trace. The margin, which can be individually assigned to each limit line in the limit line menu, is not used when generating the peak list. The numeric suffix under CALCulate<1|2> is irrelevant.

Example: " :CALC:PEAK:MARG 5 dB "

Characteristics: *RST value: 6 dB
SCPI: device specific

Mode: R

:CALCulate<1|2>:PEAKsearch|PSEarch:SUBRANGES 1 to 500

This command determines the maximum number of subranges or peaks obtained when generating the peak list. The numeric suffix under CALCulate<1|2> is irrelevant.

Example: " :CALC:PEAK:SUBR 10 "

Characteristics: *RST value: 25
SCPI: device specific

Mode: R

CALCulate<1|2>:PEAKsearch|PSEarch:METHOD SUBRANGE | PEAK

This command defines the method that is used to determine the maxima of a scan. The numeric suffix in CALCULATE<1 | 2> is not significant.

Example: " CALC:PEAK:METH SUBR "

Characteristics: *RST value: PEAK
SCPI: device specific

Mode: R

CALCulate:STATistics Subsystem

The CALCulate:STATistics subsystem controls the statistical measurement functions in the instrument. The measurement window cannot be selected with these functions. The numeric suffix in CALCulate is therefore ignored.

COMMAND	PARAMETERS	UNIT	COMMENT
CALCulate			
:STATistics			
:APD			
[:STATe]	<Boolean>	--	
:CCDF			
[:STATe]	<Boolean>	--	
:NSAMples	<numeric_value>		
:SCALe			
:AUTO	ONCE		
:X			
:RLEVel	<numeric_value>	DBM	
:RANGe	<numeric_value>	DB	
:Y			
:UPPer	<numeric_value>		
:LOWer	<numeric_value>		
:PRESet			
:RESult<1 to 3>?	MEAN PEAK CFACtor ALL		query only

CALCulate:STATistics:APD[:STATe] ON | OFF

This command switches on or off the measurement of amplitude distribution (APD). On activating this function, the CCDF measurement is switched off.

Example: "CALC:STAT:APD ON" 'Switches on the APD measurement.

Characteristics: *RST value: OFF
SCPI: device-specific

Mode: A

CALCulate:STATistics:CCDF[:STATe] ON | OFF

This command switches on or off the measurement of the complementary cumulative distribution function (CCDF). On activating this function, the APD measurement is switched off.

Example: "CALC:STAT:CCDF ON" 'Switches on the CCDF measurement.

Characteristics: *RST value: OFF
SCPI: device-specific

Mode: A

CALCulate:STATistics:NSAMples 100 to 1E9

This command sets the number of measurement points to be acquired for the statistical measurement functions.

Example: "CALC:STAT:NSAM 500" 'Sets the number of measurement points to be acquired to 500.

Characteristics: *RST value: 100000
SCPI: device-specific

Mode: A

CALCulate:STATistics:SCALE:AUTO ONCE

This command optimizes the level setting of the instrument depending on the measured peak power, in order to obtain maximum instrument sensitivity.

To obtain maximum resolution, the level range is set as a function of the measured spacing between peak power and the minimum power for the APD measurement and of the spacing between peak power and mean power for the CCDF measurement. In addition, the probability scale for the number of test points is adapted.

Note:

*Subsequent commands have to be synchronized with *WAI, *OPC or *OPC? to the end of the autorange process which would otherwise be aborted.*

Example: "CALC:STAT:SCALE:AUTO ONCE;*WAI" 'Adapts the level setting for
'statistical measurements.'

Characteristics: *RST value: --
SCPI: device-specific

Mode: A

This command is an event and therefore has no *RST value and no query.

CALCulate:STATistics:SCALE:X:RLEVel -130dBm to 30dBm

This command defines the reference level for the X axis of the measurement diagram. The setting is identical to the reference level setting using the command DISPLAY:WINDOW:TRACE:Y:RLEVel.

With the reference level offset <> 0 the indicated value range of the reference level is modified by the offset.

The unit depends on the setting performed with CALC:UNIT.

Example: "CALC:STAT:SCALE:X:RLEV -60dBm"

Characteristics: *RST value: -20dBm
SCPI: device-specific

Mode: A

CALCulate:STATistics:SCALE:X:RANGe 10dB to 200dB

This command defines the level range for the X axis of the measurement diagram. The setting is identical to the level range setting defined with the command DISPLAY:WINDOW:TRACE:Y:SCALE.

Example: "CALC:STAT:SCALE:X:RANG 20dB"

Characteristics: *RST value: 100dB
SCPI: device-specific

Mode: A

CALCulate:STATistics:SCALE:Y:UPPer 1E-8 to 1.0

This command defines the upper limit for the Y axis of the diagram in statistical measurements. Since probabilities are specified on the Y axis, the entered numerical values are dimensionless.

Example: "CALC:STAT:Y:UPP 0.01"

Characteristics: *RST value: 1.0
SCPI: device-specific

Mode: A

CALCulate:STATistics:SCALE:Y:LOWer 1E-9 to 0.1

This command defines the lower limit for the Y axis of the diagram in statistical measurements. Since probabilities are specified on the Y axis, the entered numerical values are dimensionless.

Example: "CALC:STAT:SCALE:Y:LOW 0.001"

Characteristics: *RST value: 1E-6
SCPI: device-specific

Mode: A

CALCulate:STATistics:PRESet

This command resets the scaling of the X and Y axes in a statistical measurement. The following values are set:

X axis ref level: -20 dBm
X axis range APD: 100 dB
X axis range CCDF: 20 dB

Y axis upper limit: 1.0
Y axis lower limit: 1E-6

Example: "CALC:STAT:PRESet" ' Resets the scaling for statistical functions

Characteristics: *RST value: --
SCPI: device-specific

Mode: A

This command is an event and therefore has no *RST value and no query.

CALCulate:STATistics:RESult<1 to 3>? MEAN | PEAK | CFACtor | ALL

This command reads out the results of statistical measurements of a recorded trace. The trace is selected with the numeric suffix <1 to 3> attached to RESULT.

Parameter: The required result is selected via the following parameters:

MEAN Average (=RMS) power in dBm measured during the measurement time.

PEAK Peak power in dBm measured during the measurement time.

CFACtor Determined CREST factor (= ratio of peak power to average power) in dB.

ALL Results of all three measurements mentioned before, separated by commas:
<mean power>,<peak power>,<crest factor>

Example: "CALC:STAT:RES2? ALL" 'Reads out the three measurement results of trace 2. Example of answer string:
'5.56,19.25,13.69
'i.e. mean power: 5.56 dBm, peak power 19.25 dBm, CREST factor 13.69 dB

Characteristics: *RST value: --
SCPI: device-specific

Mode: A

CALCulate:THReshold Subsystem

The CALCulate:THReshold subsystem controls the threshold value for the maximum/minimum search of markers. The measurement windows are selected by CALCulate 1 (screen A) or 2 (screen B).

COMMAND	PARAMETERS	UNIT	COMMENT
CALCulate<1 2> :DLINe<1 2>	<numeric_value>	DBM DB DEG RAD S HZ PCT	
:STATe	<Boolean>		
:THReshold	<numeric_value>	DBM DB	
:STATe	<Boolean>		
:FLINe<1 2>	<numeric_value>	HZ	
:STATe	<Boolean>		
:TLINe<1 2>	<numeric_value>	S	
:STATe	<Boolean>		

CALCulate<1|2>:DLINe<1|2> MINimum .. MAXimum (depending on current unit)

This command defines the position of Display Line 1 or 2. These lines enable the user to mark any levels in the diagram. The unit depends on the setting made with CALC:UNIT.

Example: "CALC:DLIN -20dBm"

Characteristics: *RST value: - (STATe to OFF)
SCPI: device-specific

Mode: R, A

CALCulate<1|2>:DLINe<1|2>:STATe ON | OFF

This command switches Display Line 1 or 2 (level lines) on or off.

Example: "CALC:DLIN2:STAT OFF"

Characteristics: *RST value: OFF
SCPI: device-specific

Mode: A

CALCulate<1|2>:THReshold MINimum to MAXimum (depending on current unit)

This command defines the threshold value for the maximum/minimum search of markers with marker search functions MAX PEAK, NEXT PEAK, etc in the selected measurement window. The associated display line is automatically switched on.

Example: "CALC:THR -82DBM" 'Sets the threshold value for screen A to -82 dBm.

Characteristics: *RST value: - (STATe to OFF)
SCPI: device-specific

Mode: R, A, FM

CALCulate<1|2>:THReshold:STATe ON | OFF

This command switches on or off the threshold line in the selected measurement window. The unit depends on the setting performed with `CALC:UNIT`.

Example: "CALC2:THR:STAT ON" 'Switches on the threshold line in screen B.

Characteristics: *RST value: OFF
SCPI: device-specific

Mode: R, A, FM

CALCulate<1|2>:FLINe<1|2> 0... f_{max}

This command defines the position of the frequency lines.

The frequency lines mark the frequencies specified in the measurement window. Frequency lines are only available with `SPAN > 0`.

Example: "CALC:FLIN2 120MHz"

Characteristics: *RST value: - (STATe to OFF)
SCPI: device-specific

Mode: R, A-F

CALCulate<1|2>:FLINe<1|2>:STATe ON | OFF

This command switches the frequency line on or off.

Example: "CALC:FLIN2:STAT ON"

Characteristics: *RST value: OFF
SCPI: device-specific

Mode: R, A-F

CALCulate<1|2>:TLINe<1|2> 0 ... 1000s

This command defines the position of the time lines.

The time lines mark the times specified in the measurement window. Time lines are only available with `SPAN = 0`.

Example: "CALC:TLIN 10ms"

Characteristics: *RST value: - (STATe auf OFF)
SCPI: device-specific

Mode: A-Z

CALCulate<1|2>:TLINe<1|2>:STATe ON | OFF

This command switches the time line on or off.

Example: "CALC:TLIN2:STAT ON"

Characteristics: *RST value: OFF
SCPI: device-specific

Mode: A-Z

CALCulate:UNIT Subsystem

The CALCulate:Unit subsystem defines the units for power measurement settings.

COMMAND	PARAMETERS	UNIT	COMMENT
CALCulate<1 2> :UNIT :POWer	DDBM V A W DBPW WATT DBUV DBMV VOLT DBPT DBUA AMPere DBUV_M DBMV_M		

CALCulate<1|2>:UNIT:POWer DBM | V | A | W | DBPW | WATT | DBUV | DBMV | VOLT | DBUA | AMPere | DBPT | DBUV_M | DBUA_M

This command selects the unit for power in the selected measurement window.

Example: "CALC:UNIT:POW DBM" 'Sets the power unit for screen A to dBm.

Characteristics: *RST value: dBm
SCPI: device-specific

Mode: R, A

In receiver mode, the units DBM, DBUV, DBUA, DBPW, DBT, DBUV_MHZ, DBMV_MHZ and DBUA_MHZ are available

CALibration Subsystem

The commands of the CALibration subsystem determine the data for system error correction in the instrument.

COMMAND	PARAMETERS	UNIT	COMMENT
CALibration			
[:ALL]?	--	--	query only
:ABORt	--	--	no query
:RESult?	--	--	query only
:STATe	<Boolean>	--	

CALibration[:ALL]?

This command initiates the acquisition of system error correction data. A "0" is returned if the acquisition was successful.

Note: *During the acquisition of correction data the instrument does not accept any remote control commands, except*

**RST*

CALibration:ABORt

In order to recognize when the acquisition of correction data is completed, the MAV bit in the status byte can be used. If the associated bit is set in the Service Request Enable Register, the instrument generates a service request after the acquisition of correction data has been completed.

Example:

```
*CLS "          ' Resets the status management.
*SRE 16 "      ' Enables MAV bit in the Service Request Enable Register.
*CAL? "       ' Starts the correction data recording and then a service
               ' request is generated.
```

Characteristics: *RST value: -
SCPI: conforming

Mode: all

CALibration:ABORt

This command aborts the acquisition of correction data and restores the last complete correction data set.

Example: "CAL:ABOR"

Characteristics: *RST value: -
SCPI: device-specific

Mode: all

This command is an event and therefore has no *RST value and no query.

CALibration:RESult?

This command outputs the results of the correction data acquisition. The lines of the result table (see section "Recording the correction data of R&S ESCI – CAL key") are output as string data separated by commas:

```
"Total Calibration Status: PASSED", "Date (dd/mm/yyyy): 12/07/1999",  
"Time: 16:24:54", "Runtime:00.06"
```

Example: "CAL:RES?"

Characteristics: *RST value: --
SCPI: device-specific

Mode: all

CALibration:STATe ON | OFF

This command determines whether the current calibration data are taken into account by the instrument (ON) or not (OFF).

Example: "CAL:STAT OFF" 'Sets up the instrument to ignore the calibration data.

Characteristics: *RST value: -
SCPI: conforming

Mode: all

DIAGnostic Subsystem

The DIAGnostic subsystem contains the commands which support instrument diagnostics for maintenance, service and repair. In accordance with the SCPI standard, all of these commands are device-specific.

The measurement windows are selected by DIAGnostic1 (screen A) or DIAGnostic2 (screen B) .

COMMAND	PARAMETERS	UNIT	COMMENT
DIAGnostic<1 2> :SERVice :INPut [:SElect] :PULSed [:STATe] :PRATe :SFUNction :NSOurce :CSource [:POWer] :STEst :RESult? :HWINfo?	CALibration RF <Boolean> <numeric_value> <string> <Boolean> <numeric_value>	-- Hz DBM	 no query nur Abfrage query only

DIAGnostic<1|2>:SERVice:INPut[:SElect] CALibration | RF

This command toggles between the RF input on the front panel and the internal 128-MHz reference signal in the selected measurement window. The level of the 128-MHz signals can be selected by command `DIAG:SERV:CSource`.

Example: "DIAG:SERV:INP CAL"

Characteristics: *RST value: RF
SCPI: device-specific

Mode: all

DIAGnostic<1|2>:SERVice:INPut:PULSed[:STATe] ON | OFF

This command toggles the calibration signal in the selected measurement window between pulsed and non-pulsed. The selection takes effect only if the RF input has been set to the internal reference signal using `DIAG:SERV:INP CAL`.

Example: "DIAG:SERV:INP CAL;DIAG:SERV:INP:PULS ON"

Characteristics: *RST value: OFF
SCPI: device-specific

Mode: all

This command is only available in conjunction with the optional Broadband Calibration Source R&S FSP-B15.

DIAGnostic<1|2>:SERVice:INPut:PULSed:PRATe <numeric_value>

This command selects the pulse rate for the pulsed calibration signal in the selected measurement window.

Available pulse frequencies are 10 kHz, 100 kHz, 200 kHz, 500 kHz, 1 MHz, 2 MHz, 4 MHz and 8 MHz.

Example: "DIAG:SERV:INP:PRAT 2 MHz"

Characteristics: *RST value: -
SCPI: device-specific

Mode: all

DIAGnostic<1|2>:SERvice:SFUNction <string>...

This command activates a service function which can be selected by indicating the five parameters: function group number, board number, function number, parameter 1 and parameter 2 (see service manual). The contents of the parameter string is identical to the code to be entered in the data entry field of manual operation.

The entry of a service function is accepted only if the system password Level 1 or Level 2 has been entered previously (command: SYSTem:SECurity).

The numeric suffix <1|2> is ignored with this command.

Note: *The service functions of the instrument are not identical to those of the R&S FSE family. That is why the IEC/IEEE-bus command differs in syntax and data format.*

Example: "DIAG:SERV:SFUN '2.0.2.12.1'"

Characteristics: *RST value: -
SCPI: device-specific

Mode: all

DIAGnostic<1|2>:SERvice:NSOource ON | OFF

This command switches the 28-V supply of the noise source at the rear panel on or off.

The numeric suffix <1|2> is ignored with this command.

Example: "DIAG:SERV:NSO ON"

Characteristics: *RST value: OFF
SCPI: device-specific

Mode: all

DIAGnostic<1|2>:SERvice:CSOource[:POWer] <numeric_value>

This command switches the level of the 128 MHz reference signal source between 0 dBm and -30 dBm in the selected measurement window.

Example: "DIAG:SERV:CSO 0DBM"

Characteristics: *RST value: -30 dBm
SCPI: device-specific

Mode: all

DIAGnostic<1|2>:SERvice:STES:RESult?

This command reads the results of the selftest out of the instrument. The lines of the result table are output as string data separated by commas:

```
"Total Selftest Status: PASSED", "Date (dd/mm/yyyy): 09/07/1999  
TIME: 16:24:54", "Runtime: 00:06", "..."
```

The numeric suffix <1|2> is ignored with this command.

Example: "DIAG:SERV:STES:RES?"

Characteristics: *RST value: --
SCPI: device-specific

Mode: all

DIAGnostic<1|2>:SERVice:HWInfo?

This command queries the contents of the module info table. Table lines are output as string data and are separated by commas.

"<component 1>|<serial #>|<order #>|<model>|<HWC>|<rev>|<sub rev>",
 "<component 2>|<serial #>|<order #>|<model>|<HWC>|<rev>|<sub rev>",...

The individual columns of the table are separated from each other by '|'.
 The numeric suffix <1|2> is ignored with this command.

Example: "DIAG:SERV:HWIN?"

Result (shortened):

"RF_ATTEN_7|650551/007|1067.7684|02|00|20|04",
 "IF-FILTER|648158/037|1093.5540|03|01|07|05",
 ...

Characteristics: *RST value: --
 SCPI: device-specific

Mode: all

DIAGnostic<1|2>:SERVice:IQ:CALibration:DESTination IHIGH | ILOW | QHIGH | QLOW

The calibration signals (DC Cal signal and Pulse Cal signal) can only be switched to one input at a time. This command switches the calibration signal to the I or Q path.

High selects the positive and low the negative input. The negative input is only connected through at the Balanced setting. The calibration signals are always positive. An inverted signal therefore appears in the output data during feeding into the negative input (Low).

The DC Cal signal voltage is set using the command diag:serv:iq:cal:dc, and the frequency of the Pulse Cal signal is set using the command diag:serv:iq:cal:puls:prat.

IHIGH	Feed the calibration signal into the positive I path
ILOW	Feed the calibration signal into the negative I path
QHIGH	Feed the calibration signal into the positive Q path
QLOW	Feed the calibration signal into the negative Q path

The numeric suffix <1|2> has no meaning with this command.

Example: "DIAG:SERV:IQ:CAL:DEST QHIG"

Characteristics: *RST value: IHIGH
 SCPI: device-specific

Mode: IQBB

DIAGnostic<1|2>:SERVice:IQ:CALibration:DC 0 | 0.1 | 0.178 | 0.316 | 0.562 | 1.0

This command selects the voltage for the DC Cal signal in Volt.

The numeric suffix <1|2> has no meaning with this command.

Example: "DIAG:SERV:IQ:CAL:DC 0.316"

Characteristics: *RST value: 0
 SCPI: device-specific

Mode: IQBB

DIAGnostic<1|2>:SERVice:IQ:CALibration:PULSe:PRATe 10KHz | 62.5KHz | 80KHz | 100KHz | 102.4KHz | 200KHz | 500KHz | 1MHz | 2MHz | 4MHz

This command sets the frequency of the Pulse Cal signal.

The numeric suffix <1|2> has no meaning with this command.

Example: "DIAG:SERV:IQ:CAL:PULS:PRAT 80KHZ"

Characteristics: *RST value: 62.5 kHz
 SCPI: device-specific

Mode: IQBB

DIAGnostic<1|2>:SERVice:IQ:INPut IQ | GND | CALDc | CALPulse

This command selects the baseband signal source.

IQ	The female I and Q connectors of the FSQ are the baseband signal sources.
GND	The baseband inputs are internally connected to ground.
CALDc	The baseband signal source is the DC Cal signal. The voltage of this signal can be set with diag:serv:iq:cal:dc.
CALPulse	The baseband signal source is the Pulse Cal signal. The frequency of this signal can be set with diag:serv:iq:prat.

The numeric suffix <1|2> has no meaning with this command.

Example: "DIAG:SERV:IQ:INP CALD"

Characteristics: *RST value: IQ
 SCPI: device-specific

Mode: IQBB

DISPlay Subsystem

The DISPlay subsystem controls the selection and presentation of textual and graphic information as well as of measurement data on the display.

The measurement windows are selected by WINDow1 (screen A) or WINDow2 (screen B) .

COMMAND	PARAMETERS	UNIT	COMMENT
:FORMat	SINGle SPLit		
:ANNotation			
:FREQuency	<Boolean>		
:LOGO	<Boolean>		
:PSAVe			
[:STATe]	<Boolean>		
:HOLDoff	1..60	--	
:CMAP<1...26>			
:DEFault<1 2>			
:HSL	0..1,0..1,0..1		
:PDEFined	BLACK BLUE BROWn GREen CYAN RED MAGenta YELLow WHITE DGRAY LGRAY LBLUE LGREen LCYan LRED LMAGenta		
[:WINDow<1 2>]			
:SElect			no query
:SIZE	LARGE SMALI		
:TEXT			
[:DATA]	<string>		
:STATe	<Boolean>		
:TIME	<Boolean>		
:TRACe<1...3>			
:X			
:SPACing	LINear LOGarithmic	--	
:Y			
[:SCALE]	<numeric_value>	DB	
:MODE	ABSolute RELative		
:RLEVel	<numeric_value>	DBM	
:OFFSet	<numeric_value>	DB	
:RVALue	<numeric_value>	DBM DB HZ DEG RAD	
:RPOSITion	<numeric_value>	PCT	
:PDIVision	<numeric_value>	DBM DB HZ DEG RAD	Option FM demodulator
:BOTTom	<numeric_value>	--	
:SPACing	LINear LOGarithmic LDB	--	
:MODE	WRITE VIEW AVERAge MAXHold MINHold RMS	--	
[:STATe]	<Boolean>	--	
:BARGraph			
:LEVel			
:LOWer?			
:UPPer?			
:PHOLd	<Boolean>		
:RESet			no query

DISPlay:FORMat SINGLE | SPLit

This command switches the measurement result display between FULL SCREEN and SPLIT SCREEN. The coupling of settings between screen A and screen B can be selected with the command `INSTrument:COUPle`.

In full-screen display the active measurement window can be selected with `DISPlay:WINDow<1|2>:SElect`.

Example: "DISP:FORM SPL" Switches the display to 2 measurement windows.

Characteristics: *RST value: SINGLE
SCPI: device-specific

Mode: R, A

DISPlay:ANNOtation:FREQuency ON | OFF

This command switches the X axis annotation on or off.

Example: "DISP:ANN:FREQ OFF"

Characteristics: *RST value: ON
SCPI: conforming

Mode: all

DISPlay:LOGO ON | OFF

This command switches the company logo on the screen on or off.

Example: "DISP:LOGO OFF"

Characteristics: *RST value: ON
SCPI: device-specific

Mode: all

DISPlay:PSAVe[:STATe] ON | OFF

This command switches on or off the power-save mode of the display. With the power-save mode activated the display including backlight is completely switched off after the elapse of the response time (see command `DISPlay:PSAVe:HOLDoff`).

Note: *This mode is recommended for preserving the display especially if the instrument is exclusively operated via remote control.*

Example: "DISP:PSAVe ON" Switches on the power-save mode.

Characteristics: *RST value: OFF
SCPI: device-specific

Mode: all

DISPlay:PSAVe:HOLDoff 1 to 60

This command sets the holdoff time for the power-save mode of the display. The available value range is 1 to 60 minutes, the resolution 1 minute. The entry is dimensionless.

Example: "DISP:PSAV:HOLD 30"

Characteristics: *RST value: 15
SCPI: device-specific

Mode: all

DISPlay:CMAP<1 to 33>:DEFault<1|2>

This command resets the screen colors of all display items to their default settings. Two default settings DEFault1 and DEFault2 are available. The numeric suffix of CMAP is irrelevant.

Example: "DISP:CMAP:DEF2" 'Selects default setting 2 for setting the colors.

Characteristics: *RST value: --
SCPI: conforming

Mode: all

This command is an event and therefore has no query and no *RST value .

DISPlay:CMAP<1 to 33>:HSL <hue>,<sat>,<lum>

This command defines the color table of the instrument.

Each numeric suffix of CMAP is assigned one or several graphical elements which can be modified by varying the corresponding color setting. The following assignment applies:

CMAP1	Background
CMAP2	Grid
CMAP3	Function field + status field + data entry text
CMAP4	Function field LED on
CMAP5	Function field LED warn
CMAP6	Enhancement label text
CMAP7	Status field background
CMAP8	Trace 1
CMAP9	Trace 2
CMAP10	Trace 3
CMAP11	Marker
CMAP12	Lines
CMAP13	Measurement status + limit check pass
CMAP14	Limit check fail
CMAP15	Table + softkey background
CMAP16	Table + softkey text
CMAP17	Table selected field text
CMAP18	Table selected field background
CMAP19	Table + data entry field opaq titlebar
CMAP20	Data entry field opaq text
CMAP21	Data entry field opaq background
CMAP22	3D shade bright part
CMAP23	3D shade dark part
CMAP24	Softkey state on
CMAP25	Softkey state data entry
CMAP26	Logo
CMAP27	Bargraph PK+
CMAP28	Bargraph PK-
CMAP29	Bargraph QPK
CMAP30	Bargraph AVER
CMAP31	Bargraph RMS
CMAP32	Final Meas
CMAP33	Bargraph CAV

Parameter: hue = TINT; sat = SATURATION; lum = BRIGHTNESS
The value range is 0 to 1 for all parameters.

Example: "DISP:CMAP2:HSL 0.3,0.8,1.0" Changes the grid color.

Characteristics: *RST value: --
SCPI: conforming

Mode: all

The values set are not changed by *RST.

DISPlay:CMAP<1 to 33>:PDEFined BLACK | BLUE | BROWn | GREen | CYAN | RED | MAGenta |
 YELLOW | WHITE | DGRAY | LGRAY | LBLUe | LGREEN | LCYan
 | LRED | LMAGenta

This command defines the color table of the instrument using predefined color values. Each numeric suffix of CMAP is assigned one or several graphical elements which can be modified by varying the corresponding color setting.

The same assignment as for `DISPlay:CMAP<1 to 33>:HSL` applies.

Example: `"DISP:CMAP2:PDEF GRE"`

Characteristics: *RST value: --
 SCPI: conforming

Mode: all

The values set are not changed by *RST.

DISPlay[:WINDow<1|2>]:SElect

This command selects the active measurement window. WINDow1 corresponds to SCREEN A, WINDow2 to SCREEN B.

In FULL SCREEN mode, the measurements are only performed in the active measurement window. Measurements are therefore initiated in the active window and result queries (marker, trace data and other results) answered also in the active window.

Initiating measurements and querying results in the inactive window yields an error message (execution error).

In split screen mode, the selection of the active window for result queries is irrelevant.

Note: - In FULL SCREEN mode, settings can also be performed in the inactive measurement window. They become effective as soon as the corresponding window becomes active.

Example: `"DISP:WIND2:SEL 'Selects SCREEN B as active measurement window."`

Characteristics: *RST value: SCREEN A active
 SCPI: device-specific

Mode: A

This command is an event and therefore has no query.

DISPlay[:WINDow<1|2>]:SIZE LARGE | SMALL

This command switches the measurement window for channel and adjacent-channel power measurements or for active FM demodulator (FS-K7) to full screen or half screen. Only "1" is allowed as a numerical suffix.

Example: `"DISP:WIND1:SIZE LARG"` Switches the measurement window to full screen.

Characteristics: *RST value: SMALL
 SCPI: device-specific

Mode: A, FM

DISPlay[:WINDow<1|2>]:TEXT[:DATA] <string>

This command defines a comment (max. 20 characters) which can be displayed on the screen in the selected measurement window.

Example: `"DISP:WIND2:TEXT 'Noise Measurement'"`
 'Defines the title for screen B

Characteristics: *RST value: "" (empty)
 SCPI: conforming

Mode: all

DISPlay[:WINDow<1|2>]:TEXT:STATe ON | OFF

This command switches on or off the display of the comment (screen title) in the selected measurement window.

Example: "DISP:TEXT:STAT ON" 'Switches on the title of screen B.

Characteristics: *RST value: OFF
SCPI: conforming

Mode: all

DISPlay[:WINDow<1|2>]:TIME ON | OFF

This command switches on or off the screen display of date and time. The numeric suffix in WINDow<1|2> is irrelevant.

Example: "DISP:TIME ON"

Characteristics: *RST value: OFF
SCPI: device-specific

Mode: all

DISPlay[:WINDow<1|2>]:TRACe<1 to 3>:X:SPACing LINear | LOGarithmic

This command toggles between linear and logarithmic display in receiver mode

Example: "DISP:TRAC:X:SPAC LIN"

Characteristics: *RST value: LOGarithmic
SCPI: conforming

Modes: R, A

The numeric suffix in TRACe<1 to 3> is irrelevant.

DISPlay[:WINDow<1|2>]:TRACe<1 to 3>:Y[:SCALE] 10dB to 200dB

This command defines the display range of the Y axis (level axis) in the selected measurement window with logarithmic scaling (DISP:TRAC:Y:SPAC LOG).

For linear scaling, (DISP:TRAC:Y:SPAC LIN | PERC) the display range is fixed and cannot be modified. The numeric suffix in TRACe<1 to 3> is irrelevant.

Example: "DISP:TRAC:Y 110dB"

Characteristics: *RST value: 100dB
SCPI: device-specific

Mode: all

DISPlay[:WINDow<1|2>]:TRACe<1 to 3>:Y[:SCALE]:MODE ABSolute | RELative

This command defines the scale type of the Y axis (absolute or relative) in the selected measurement window.

When SYSTem:DISPlay is set to OFF, this command has no immediate effect on the screen. The numeric suffix in TRACe<1 to 3> is irrelevant.

Example: "DISP:TRAC:Y:MODE REL"

Characteristics: *RST value: ABS
SCPI: device-specific

Mode: all

DISPlay[:WINDow<1|2>]:TRACe<1 to 3>:Y[:SCALe]:RLEVel -130dBm to 30dBm

This command defines the reference level in the selected measurement window. Depending on the coupling of the measurement windows, it is valid for both screens (INSTRument:COUPle ALL) or only for the selected measurement window (INSTRument:COUPle NONE).

With the reference level offset <> 0 the indicated value range of the reference level is modified by the offset.

The unit depends on the setting defined with CALCulate:UNIT. The numeric suffix in TRACe<1 to 3> is irrelevant.

Example: "DISP:TRAC:Y:RLEV -60dBm"

Characteristics: *RST value: -20dBm
SCPI: conforming

Mode: A

DISPlay[:WINDow<1|2>]:TRACe<1 to 3>:Y[:SCALe]:RLEVel:OFFSet -200dB to 200dB

This command defines the offset of the reference level in the selected measurement window. Depending on the coupling of the measurement windows, it is valid for both screens (INSTRument:COUPle ALL) or only for the selected measurement window (INSTRument:COUPle NONE).

The numeric suffix at TRACe<1 to 3> is irrelevant.

Example: "DISP:TRAC:Y:RLEV:OFFS -10dB"

Characteristics: *RST value: 0dB
SCPI: conforming

Mode: A

DISPlay[:WINDow<1|2>]:TRACe<1 to 3>:Y[:SCALe]:RVALue <numeric_value>

If the tracking generator option or the external generator control option (R&S FSP-B9/B10) is mounted and the normalization in the NETWORK mode is activated, this value defines the power value assigned to the reference position in the selected measurement window. This value corresponds to the parameter REFERENCE VALUE in manual operation.

The numeric suffix at TRACe<1 to 3> is irrelevant.

Example: "DISP:TRAC:Y:RVAL 0" 'Sets the power value assigned to the 'reference position to 0 dB (Tracking Generator/Ext. Generator Control option) or 0 Hz (FM demodulator option)

Characteristics: *RST value: 0 dB (Mode NETWORK)
0 Hz (FM demodulator mode with FM display)
2.5MHz (FM demodulator mode with AF spectrum display of FM)
SCPI: device specific

Modes: A

DISPlay[:WINDow<1|2>]:TRACe<1 to 3>:Y[:SCALE]:RPOsition 0 to 100PCT

This command defines the position of the reference value in the selected measurement window. The numeric suffix in TRACe<1 to 3> is irrelevant.

In operating mode NETWORK (Tracking Generator /Ext. Generator Option R&S FSP-B9/B10) with active normalization, RPOsition defines the reference point for the output of the normalized measurement results.

With the FM demodulator (FS-K7) switched on, the reference position for result display RF POWER and SPECTRUM is kept separate from that for result display FM.

Example: "DISP:TRAC:Y:RPOS 50PCT"

Characteristics: *RST value: 100PCT(SPECTRUM mode)
50 PCT (NETWORK and FM DEMOD mode)
50 PCT (Mode FM-DEMOM mit FM display)
100 PCT(Mode FM-DEMOM mit AF spectrum display of FM)

SCPI: conforming

Mode: A

DISPlay[:WINDow<1|2>]:TRACe<1 to 3>:Y[:SCALE]:PDIVision <numeric_value>

This command defines the scaling of the Y axis in the current unit.

Example: "DISP:TRAC:Y:PDIV +1.20"

Characteristics: *RST value: -
SCPI: conforming

Mode: FM

The numeric suffix in TRACe<1 to 3> is irrelevant. The command is only available with option R&S FS-K7 (FM Demodulator).

DISPlay[:WINDow<1|2>]:TRACe<1 to 3>:Y[:SCALE]:BOTTom <numeric_value>

This command defines the minimum grid level in the current unit for the scan display in the receiver mode.

Example: "DISP:TRAC:Y:BOTT -20" The minimum grid level is set to -20 dBuV
(pre-condition: the default unit has not been changed)

Characteristics: *RST value: 0
SCPI: conforming

Mode: R

The numeric suffix in TRACe<1 to 3> is irrelevant.

DISPlay[:WINDow<1|2>]:TRACe<1 to 3>:Y:SPACing LINear | LOGarithmic| LDB

This command toggles between linear and logarithmic display in the selected measurement window. On a linear scale, switchover between the unit % (command DISP:WIND:TRAC:Y:SPAC LIN) and the unit dB (command DISP:WIND:TRAC:Y:SPAC LDB) is also possible.

If the FM demodulator (FS-K7) is active and result display AF spectrum of FM is selected, only the parameters LINear and LOGarithmic are permissible.

The numeric suffix in TRACe<1 to 3> is irrelevant.

Example: "DISP:TRAC:Y:SPAC LIN"

Characteristics: *RST value: LOGarithmic
SCPI: conforming

Mode: A, FM

DISPlay[:WINDow<1|2>]:TRACe<1 to 3>:MODE WRITe | VIEW | AVERAge | MAXHold | MINHold

This command defines the type of display and the evaluation of the traces in the selected measurement window. WRITe corresponds to the Clr/Write mode of manual operation. The trace is switched off (= BLANK in manual operation) with `DISP:WIND:TRAC:STAT OFF`.

The number of measurements for AVERAge, MAXHold and MINHold is defined with the command `SENSe:AVERAge:COUNT` or `SENSe:SWEep:COUNT`. It should be noted that synchronization to the end of the indicated number of measurements is only possible in single sweep mode.

If calculation of average values is active, selection between logarithmic and linear averaging is possible. For more detail see command `SENSe:AVERAge:TYPE`.

Example:

"SWE:CONT OFF"	Switching to single-sweep mode.
"SWE:COUN 16"	'Sets the number of measurements to 16.
"DISP:WIND1:TRAC3:MODE MAXH"	'Switches on the calculation of the for 'trace 3 in screen A.
"INIT;*WAI"	'Starts the measurement and waits for the end of the '16 sweeps.

Characteristics: *RST value: WRITe for TRACe1, STATe OFF for TRACe2/3
SCPI: device-specific

Mode: all

DISPlay[:WINDow<1|2>]:TRACe<1 to 3>[:STATe] ON | OFF

This command switches on or off the display of the corresponding trace in the selected measurement window.

Example: "DISP:WIND1:TRAC3 ON"

Characteristics: *RST value: ON for TRACe1, OFF for TRACe2 to 4
SCPI: conforming

Mode: all

DISPlay[:WINDow<1|2>]:TRACe<1 to 3>:SYMBOL CROSS | OFF

This command switches on or off the indication of the peak list or the final measurement result on the trace.

CROSS The single value is indicated as x.

OFF No indication.

Example: "DISP:TRAC:SYMB CROSS"

Characteristics: *RST value: OFF
SCPI: device-specific

Mode: R

:DISPlay:BARGraph:LEVel:LOWer?

This command queries the minimum level of the bargraph.

Example: ":DISP:BARGraph:LEV:LOW?"

Characteristics: *RST value: --
SCPI: device-specific

Mode: R

:DISPlay:BARGraph:LEVel:UPPer?

This command queries the maximum level of the bargraph.

Example: " :DISP: BARG: LEV: UPP? "

Characteristics: *RST value: --
SCPI: device-specific

Mode: R

:DISPlay:BARGraph:PHOLd ON | OFF

This command switches on the numeric indication of the maximum value of the bargraph.

Example: " :DISP: BARG: PHOL ON"

Characteristics: *RST value: OFF
SCPI: device-specific

Mode: R

:DISPlay:BARGraph:PHOLd:PRESet

This command resets the maxhold value of the numeric indication of the bargraph measurement.

Example: " :DISP: BARG: PHOL: RES"

Characteristics: *RST value: --
SCPI: device-specific

Mode: R

This command is an event and thus has no *RST value and no query.

FORMat Subsystem

The FORMat subsystem specifies the data format of the data transmitted from and to the instrument.

COMMAND	PARAMETERS	UNIT	COMMENT
FORMat [:DATA] :DEXPort :DSEParator	ASCIi REAL[,<numeric_value>] POINt COMMa	-	

FORMat[:DATA] ASCii | REAL| UINT [, 8 | 32]

This command specifies the data format for the data transmitted from the instrument to the control PC.

The format settings below are valid for the binary transmission of trace data(see also TRACE:DATA?):

Mode SPECTRUM: REAL, 32

Example: "FORM REAL, 32"
"FORM ASC"
"FORM UINT, 8"

Characteristics: *RST value: ASCII
SCPI: conforming

Mode: all

The data format is either ASCII or one of the formats REAL. ASCII data are transmitted in plain text, separated by commas. REAL data are transmitted as 32-bit IEEE 754 floating-point numbers in the "definite length block format".

The FORMat command is valid for the transmission of trace data. The data format of trace data received by the instrument is automatically recognized, regardless of the format which is programmed.

Format setting for the binary transmission of trace data (see also TRACE:DATA?):

Analyzer mode: REAL, 32

FORMat:DEXPort:DSEParator POINt|COMMA

This command defines which decimal separator (decimal point or comma) is to be used for outputting measurement data to the file in ASCII format. Different languages of evaluation programs (e.g. MS-Excel) can thus be supported.

Example: "FORM:DEXP:DSEP POIN" 'Sets the decimal point as separator.

Characteristics: *RST value: -- (factory setting is POINt; *RST does not affect setting)
SCPI: device-specific

Mode: all

HCOPY Subsystem

The HCOpy subsystem controls the output of display information for documentation purposes on output devices or files. The instrument allows two independent printer configurations which can be set separately with the numeric suffix <1|2>.

COMMAND	PARAMETERS	UNIT	COMMENT
HCOPY			
:ABORt	--	--	no query
:CMAp<1 to 33>			
:DEFault<1 2 3>			
:HSL	0..1,0..1,0..1		
:PDEFined	BLACK BLUE BROWn GREen CYAN RED MAGenta YELLow WHITe DGRAY LGRAY LBLUe LGREen LCYan LRED LMAGenta		
:DESTination<1 2>	<string>		no query
:DEVice			
:COLor	<Boolean>		
:LANGuage<1 2>	WMF GDI EWMF BMP		
[:IMMediate<1 2>]	--	--	no query
:ITEM			
:ALL			no query
:WINDow<1 2>			
:TABLE			
:STATe	<Boolean>		
:TEXT	<string>		
:TRACe			
:STATe	<Boolean>		
:PAGE			
:ORientation<1 2>	LANDscape PORTrait		

HCOPY:ABORt

This command aborts a running hardcopy output.

Example: "HCOP : ABOR "

Characteristics: *RST value: -
SCPI: conforming

Mode: all

This command is an event and therefore has no *RST value and no query.

HCOPY:CMAp<1 to 33>:DEFault1|2|3

This command resets the colors for a hardcopy to the selected default settings. DEFault1 (SCREEN COLORS, but background white), DEFault2 (OPTIMIZED COLOR SET) and DEFault3 (USER DEFINED). The numeric suffix in CMAP is not significant.

Example: "HCOP : CMAP : DEF 2 " 'selects OPTIMIZED COLOR SET for the color settings of a hardcopy.

Characteristics: *RST value: --
SCPI: conforming

Modes: all

This command is an event and therefore has no query and no *RST value.

HCOPy:CMAP<1 to 33>:HSL <hue>,<sat>,<lum>

This command defines the color table in USER DEFINED COLORS mode.

To each numeric suffix of CMAP is assigned one or several picture elements which can be modified by varying the corresponding color setting. The following assignment applies:

- CMAP1 Background
- CMAP2 Grid
- CMAP3 Function field + status field + data entry text
- CMAP4 Function field LED on
- CMAP5 Function field LED warn
- CMAP6 Enhancement label text
- CMAP7 Status field background
- CMAP8 Trace 1
- CMAP9 Trace 2
- CMAP10 Trace 3
- CMAP11 Marker
- CMAP12 Lines
- CMAP13 Measurement status + Limit check pass
- CMAP14 Limit check fail
- CMAP15 Table + softkey background
- CMAP16 Table + softkey text
- CMAP17 Table selected field text
- CMAP18 Table selected field background
- CMAP19 Table + data entry field opaque titlebar
- CMAP20 Data entry field opaque text
- CMAP21 Data entry field opaque background
- CMAP22 3D shade bright part
- CMAP23 3D shade dark part
- CMAP24 Softkey state on
- CMAP25 Softkey state data entry
- CMAP26 Logo
- CMAP27 Bargraph PK+
- CMAP28 Bargraph PK-
- CMAP29 Bargraph QPK
- CMAP30 Bargraph AVER
- CMAP31 Bargraph RMS
- CMAP32 Final Meas
- CMAP33 Bargraph CAV

Parameter: hue = tint
 sat = saturation
 lum = brightness
 The value range is 0 to 1 for all parameters

Example: "HCOP:CMAP2:HSL 0.3,0.8,1.0" ' changes the grid color

Characteristics: *RST value: --
 SCPI: conforming

Modes: all

The values set are not changed by *RST.

HCOPY:CMAP<1 to 33>:PDEFined BLACK | BLUE | BROWN | GREEN | CYAN | RED | MAGenta |
YELLOW | WHITE | DGRAY | LGRAY | LBLUE | LGREEN | LCYan
| LRED | LMAGenta

This command defines the color table in USER DEFINED COLORS using predefined color values. To each numeric suffix of CMAP is assigned one or several picture elements which can be modified by varying the corresponding color setting. The same assignment as for :HCOPY:CMAP<1 to 26>:HSL applies

Example: "HCOPY:CMAP2:PDEF GRE"

Characteristics: *RST value: --
SCPI: conforming

Modes: all

The values set are not changed by *RST.

HCOPY:DESTination<1|2> <string>

This command selects the printer output medium (Disk, Printer or Clipboard) associated with configuration 1 or 2.

Note: *The type of instrument is selected with SYSTEM:COMMunicate:PRINter:SElect, which will automatically select a default output medium. Therefore the command HCOPY:DESTination should always be sent after setting the device type.*

Parameter: <string>::= 'MMEM' |
'SYST:COMM:PRIN' |
'SYST:COMM:CLIP'
'MMEM' 'Directs the hardcopy to a file. Command MMEM:NAME
'<file_name>' defines the file name. All formats can be
'selected for HCOPY:DEVIce:LANGuage.
'SYST:COMM:PRIN' 'Directs the hardcopy to the printer. The printer is
'selected with command
'SYSTEM:COMMunicate:PRINter:SElect.
'GDI should be selected for
'HCOPY:DEVIce:LANGuage.
'SYST:COMM:CLIP' 'Directs the hardcopy to the clipboard. EWMF should be
'selected for HCOPY:DEVIce:LANGuage.

Example: "SYST:COMM:PRIN:SEL2 'LASER on LPT1'" 'Selects the printer and output
'medium for device 2
"HCOPY:DEST2 'SYST:COMM:PRIN'" 'Selects the printer interface
'as device 2.

Characteristics: *RST value: -
SCPI: conforming

Mode: all

This command is an event and therefore has no *RST value and no query.

HCOPY:DEVIce:COLor ON|OFF

This command selects between color and monochrome hardcopy of the screen.

Example: "HCOPY:DEV:COL ON"

Characteristics: *RST value: OFF
SCPI: conforming

Mode: all

HCOPY:DEVIce:LANGUage<1|2> GDI | WMF | EWMF | BMP

This command determines the data format of the printout.

Parameter: GDI Graphics Device Interface:
 Default format for the output to a printer configured under Windows.
 Must be selected for the output to the printer interface (HCOPY:DEVIce 'SYST:COMM:PRIN').
 Can be used for the output to a file (HCOPY:DEVIce 'SYST:COMM:MMEM'). The printer driver configured under Windows is used in this case and a printer-specific file format is thus generated.

WMF and EWMF WINDOWS Metafile and Enhanced Metafile Format:
 Data formats for output files which can be integrated in corresponding programs for documentation purposes at a later time. WMF can only be used for output to a file (HCOPY:DEVIce 'SYST:COMM:MMEM') and EWMF also for the output to the clipboard (HCOPY:DEVIce 'SYST:COMM:CLIP').

BMP Bitmap.
 Data format for output to files only (HCOPY:DEVIce 'SYST:COMM:MMEM').

Example: "HCOP:DEV:LANG WMF"

Characteristics: *RST value: -
 SCPI: conforming

Mode: all

HCOPY[:IMMEDIATE<1|2>]

This command starts a hardcopy output. The numeric suffix selects which printer configuration (1 or 2) is to be used for the hardcopy output. If there is no suffix, configuration 1 is automatically selected.

HCOPY: IMM[1] 'Starts the hardcopy output to device 1 (default).
 HCOPY: IMM2 'Starts the output to device 2.

Example: "HCOP"

Characteristics: *RST value: -
 SCPI: conforming

Mode: all

This command is an event and therefore has no *RST value and no query.

HCOPY:ITEM:ALL

This command selects the complete screen to be output.

Example: "HCOP:ITEM:ALL"

Characteristics: *RST value: OFF
 SCPI: conforming

Mode: all

The hardcopy output is always provided with comments, title, time and date. As an alternative to the whole screen, only traces (commands 'HCOPY:ITEM:WINDOW:TRACE: STATE ON') or tables (command 'HCOPY:ITEM:WINDOW:TABLE: STATE ON') can be output.

HCOPY:ITEM:WINDow<1|2>:TABle:STATe ON | OFF

This command selects the output of the currently displayed tables.

Example: "HCOP:ITEM:WIND:TABL:STAT ON"

Characteristics: *RST value: OFF
SCPI: device-specific

Mode: all

The command `HCOPY:DEVIce:ITEM:WINDow<1 | 2>:TABle:STATe OFF` as well as command `HCOPY:DEVIce:ITEM:ALL` enables the output of the whole screen.

HCOPY:ITEM:WINDow<1|2>:TEXT <string>

This command defines the comment text for measurement window 1 or 2 for printout, with a maximum of 100 characters; line feed by means of character @).

Example: "HCOP:ITEM:WIND2:TEXT `comment`"

Characteristics: *RST value: -
SCPI: device-specific

Mode: all

HCOPY:ITEM:WINDow<1|2>:TRACe:STATe ON | OFF

This command selects the output of the currently displayed trace.

Example: "HCOP:ITEM:WIND:TRACe:STAT ON"

Characteristics: *RST value: OFF
SCPI: device-specific

Mode: all

The command `HCOPY:ITEM:WINDow<1 | 2>:TRACe:STATe OFF` as well as command `HCOPY:ITEM:ALL` enables the output of the whole screen.

HCOPY:PAGE:ORientation<1|2> LANDscape | PORTRait

The command selects the format of the output (portrait and landscape) (hardcopy unit 1 or 2).

Note:

The command is only available provided that the output device "printer" (HCOP:DEST 'SYST:COMM:PRIN') has been selected.

Example: "HCOP:PAGE:ORI LAND"

Characteristics: *RST value: -
SCPI: conforming

Mode: all

INITiate Subsystem

The INITiate subsystem is used to control the init measurement function in the selected measurement window. In receiver mode, a distinction is made between single measurement (INITiate1) and scan (INITiate2). In signal analyzer mode, a distinction is made between INITiate1 (screen A) and INITiate2 (screen B) in split screen representation.

COMMAND	PARAMETERS	UNIT	COMMENT
INITiate<1 2> :CONTInuous :CONMeas [:IMMEDIATE] :DISPlay	<Boolean> -- -- <Boolean>	-- -- -- --	 no query no query

INITiate<1|2>:CONTInuous ON | OFF

This command determines whether the trigger system is continuously initiated (continuous) or performs single measurements (single).

Setting "INITiate:CONTInuous ON" corresponds to function SCAN/SWEEP CONTInuous, i.e. the scan/sweep of the receiver/analyzer is cyclically repeated. The setting "INITiate:CONTInuous OFF" corresponds to function SCAN/SWEEP SINGLE..

Example:

```
"INIT2:CONT OFF" 'Switches the sequence in screen B to single
                    'scan/sweep.
"INIT2:CONT ON"  'Switches the sequence to continuous scan/sweep.
```

Characteristics: *RST value: ON
SCPI: conforming

Mode: all

INITiate<1|2>:CONMeas

When a scan is automatically interrupted by a transducer interrupt point, this command continues the measurement at the current receiver frequency. A selectively interrupted scan (INTERRUPT) is continued by a new INITiate2:IMMEDIATE command.

This command continues a stopped measurement at the current position in single sweep mode. The function is useful especially for trace functions MAXHold, MINHold and AVERage if the previous results are not to be cleared with Sweep Count > 0 or Average Count > 0 on restarting the measurement (INIT:IMMEDIATE resets the previous results on restarting the measurement).

The single-sweep mode is automatically switched on. Synchronization to the end of the indicated number of measurements can then be performed with the command *OPC, *OPC? or *WAI. In the continuous-sweep mode, synchronization to the sweep end is not possible since the overall measurement "never" ends.

Example:

```
"INIT:CONT OFF" 'Switches to single-sweep mode.
"DISP:WIND:TRAC:MODE AVER" 'Switches on trace averaging.
"SWE:COUN 20" 'Setting the sweep counter to 20 sweeps.
"INIT;*WAI" 'Starts the measurement and waits for the
             'end of the 20 sweeps.
"INIT:CONM;*WAI" 'Continues the measurement (next 20
                 'sequences) and waits for the end.
```

Characteristics: *RST value: -
SCPI: device-specific

Mode: R, A

This command is an event and therefore has no *RST value and no query.

INITiate<1|2>[:IMMediate]

The command initiates a new sweep in the indicated measurement window.

In receiver mode with *SINGLE* selected, the R&S ESCI performs a single scan and stops at the end frequency. With *CONTINUOUS* selected, the scan is performed continuously until it is deliberately stopped.

In analyzer mode, with Sweep Count > 0 or Average Count > 0, this means a restart of the indicated number of measurements. With trace functions MAXHold, MINHold and AVERage, the previous results are reset on restarting the measurement.

In single sweep mode, synchronization to the end of the indicated number of measurements can be achieved with the command *OPC, *OPC? or *WAI. In continuous-sweep mode, synchronization to the sweep end is not possible since the overall measurement never ends.

Example:

"INIT:CONT OFF"	'Switches to single-sweep mode.
"DISP:WIND:TRAC:MODE AVER"	'Switches on trace averaging.
"SWE:COUN 20"	Setting the sweep counter to 20 sweeps.
"INIT;*WAI"	'Starts the measurement and waits for the end of the 20 sweeps.

Characteristics: *RST value: -
SCPI: conforming

Mode: all

This command is an event and therefore has no *RST value and no query.

INITiate<1|2>:DISPlay ON | OFF

This command configures the behavior of the display during a single sweep.

INITiate:DISPlay OFF means that the display is switched off during the measurement,

INITiate:DISPlay ON means that the display is switched on during the measurement.

The numeric suffix of INITiate is irrelevant with this command.

Example:

"INIT:CONT OFF"	'Switches to single-sweep mode
"INIT:DISP OFF"	'Sets the display behavior to OFF
"INIT;*WAI"	'Starts the measurement with display switched off.

Characteristics: *RST value: ON
SCPI: device-specific

Mode: A

INPut Subsystem

The INPut subsystem controls the input characteristics of the RF inputs of the instrument. In receiver mode, the suffix is irrelevant. In the analyzer mode, the measurement windows are assigned to INPut1 (screen A) and INPut2 (screen B).

COMMAND	PARAMETERS	UNIT	COMMENT
INPut<1 2>			
:ATTenuation	<numeric_value>	DB	
:AUTO	<Boolean>	--	
:PROTection [:STATe]	<Boolean>	--	
:COUPling	AC DC		
:LISN [:TYPE]	TWOPhase FOURphase OFF		
:PHASe	L1 L2 L3 N		
:PEARth	GROunded FLOating		
:UPORt [:VALue?]	--	--	nur Abfrage
:STATe	<Boolean>		
:IMPedance	50 75	OHM	
:GAIN :STATe	<Boolean>		
:AUTO	<Boolean>		
:PRESelection [:STATe]	<Boolean>		

INPut<1|2>:ATTenuation 0 ... 75dB

This command programs the input attenuator. To protect the input mixer against damage from overloads, the setting 0 dB can be obtained by entering numerals, not by using the command DEC.

The step width is 5 dB, the range is 0 dB to..75 dB.

In the default state with analyzer mode, the attenuation set on the step attenuator is coupled to the reference level of the instrument. If the attenuation is programmed directly, the coupling to the reference level is switched off.

With receiver mode, if the attenuation is programmed directly, the auto range function is switched off if necessary. Settings below 10 dB can be prevented by activating the protection function (INPut:ATTenuation:PROTection ON).

Example: "INP:ATT 40dB" 'Sets the attenuation on the attenuator to 40 dB and switches off the coupling to the reference level.

Characteristics: *RST value: 10 dB (AUTO is set to ON)
SCPI: conforming

Mode: all

INPut<1|2>:ATTenuation:AUTO ON | OFF

In analyzer mode, this command automatically couples the input attenuation to the reference level (state ON) or switches the input attenuation to manual entry (state OFF). The minimum input attenuation set with the coupling switched on is 10 dB.

In receiver mode, this command automatically sets the attenuation so that a good S/N ratio is obtained without the receiver stages being overdriven (state ON).

Example: "INP:ATT:AUTO ON" ' Couples the attenuation set on the attenuator to the 'reference level.

Characteristics: *RST value: ON
SCPI: conforming

Mode: all

INPut<1|2>:ATTenuation:PROTection[:STATe] ON | OFF

This command defines whether the 0 dB position of the attenuator is to be used in manual or automatic adjustment.

Example: "INP:ATT:PROT ON"

Characteristics: *RST value: OFF
SCPI: device-specific

Mode: R

INPut:COUPling AC | DC

This command switches the input coupling of the RF input between AC and DC.

Example: "INP:COUP DC"

Characteristics: *RST value: AC
SCPI: conforming

Mode: A

INPut<1|2>:LISN[:TYPE] TWOPhase | FOURphase | OFF

This command selects the V-network to be controlled via the user port:

TWOPhase = Two-line V-network R&S ESH3-Z5

FOURphase = Four-line V-network R&S ESH2-Z5 or R&S ENV4200

OFF = remote control is deactivated

Example: ":INP:LISN:TWOP"

Characteristics: *RST value: OFF
SCPI: device specific

Mode: R, A

INPut<1|2>:LISN:PHASe L1 | L2 | L3 | N

This command selects the phase of the V-network on which the RFI voltage is to be measured.

Example: ":INP:LISN:PHAS L1"

Characteristics: *RST value: L1
SCPI: device specific

Mode: R, A

INPut<1|2>:LISN:PEARth GROunded | FLOating

This command selects the setting of the protection earth of the V-network.

Example: " : INP : LISN : PEAR GRO "

Characteristics: *RST value: GROunded
SCPI: device specific

Mode: R, A

INPut<1|2>:UPORt[:VALue]?

This command queries the control lines of the user ports.

Example: "INP:UPOR?"

Characteristics: *RST value: -
SCPI: device-specific

Modes: all

This command is a query and therefore has no *RST value.

INPut<1|2>:UPORt:STATe ON | OFF

This command toggles the control lines of the user ports between INPut and OUTPut.

Example: " INP : UPOR : STAT ON "

Characteristics: *RST value: ON
SCPI: device-specific

Modes: all

With ON, the user port is switched to INPut, with OFF to OUTPut.

INPut<1|2>:IMPedance 50 | 75

This command sets the nominal input impedance of the instrument. The set impedance is taken into account in all level indications of results..

The setting 75 Ω should be selected, if the 50 Ω input impedance is transformed to a higher impedance using a 75 Ω adapter of the RAZ type (= 25 Ω in series to the input impedance of the instrument). The correction value in this case is 1.76 dB = 10 log (75 Ω / 50 Ω).

Example: "INP:IMP 75"

Characteristics: *RST value: 50 Ω
SCPI: conforming

Mode: all

INPut<1|2>:GAIN:STATe ON | OFF

This command switches on the preamplifier for the instrument. The switchable gain is fixed to 20 dB..

In analyzer mode, the command is only available, if the preselector measurement has been activated.

Example: "INP:GAIN ON" 'Switches on 20 dB preamplification

Characteristics: *RST value: OFF
SCPI: conforming

Modes: R, A

INPut<1|2>:GAIN:AUTO ON | OFF

This command includes the preamplifier into the autoranging function of the receiver.

Example: " : INP : GAIN : AUTO ON " ' Includes the preamplifier into the auto range function

Characteristics: *RST value: OFF
SCPI: conforming

Mode: R

:INPut<1|2>:PRESelection[:STATe] ON | OFF

In analyzer mode, this command switches the preselection on or off.

Example: " : INP : PRES : STAT ON "

Characteristics: *RST value: OFF
SCPI: device-specific

Modes: A

INSTRument Subsystem

The INSTRument subsystem selects the operating mode of the unit either via text parameters or fixed numbers.

COMMAND	PARAMETERS	UNIT	COMMENT
INSTRument [:SElect] :NSElect :CONFigure<1 2> [:DISPlay] :MIxed :COUple :ATTenuation :BANDwidth :BWIDth :CENTer :DEModulation :GAIN :PRESelector :PROTection :SPAN	SANalyzer ADEMod RECeiver <numeric_value> SANalyzer RECeiver <Boolean> NONE RLEVel CF_B CF_A ALL NONE ALL NONE ALL NONE ALL NONE ALL NONE ALL NONE ALL NONE ALL NONE ALL NONE ALL NONE		no query

INSTRument[:SElect] SANalyzer | RECeiver | ADEMod

This command switches between the operating modes by means of text parameters.

Parameter: SANalyzer: Spectrum analysis
 ADEMod FM demodulator
 RECeiver: EMI receiver

Example: "INST SAN" 'Switches the instrument to *SPECTRUM*.

Characteristics: *RST value: RECeiver
 SCPI: conforming

Mode: all

Changeover to ADEMod is only possible with FM Demodulator FS-K7 option installed.

INSTRument:NSElect 1 | 3 | 6

This command switches between the operating modes by means of numbers.

Parameter: 1: Spectrum analysis
 3: FM demodulator
 6: EMI Receiver

Example: "INST:NSEL 1" 'Switches the instrument to *SPECTRUM*.

Characteristics: *RST value: 6
 SCPI: conforming

Mode: all

Changeover to 3 is only possible with FM Demodulator FS-K7 option installed.

INSTrument:COUPlE:ATTenuation ALL | NONE

This command couples the RF attenuation settings for the analyzer and receiver modes to each other. The RF attenuation and level unit are set to the same value in the analyzer and receiver screens.

Example: "INST:COUP:ATT ALL"
Characteristics: *RST value: ALL
SCPI: device specific
Mode: R, A

INSTrument:COUPlE:BANDwidth|BWIDth ALL | NONE

This command couples the bandwidth settings for the analyzer and receiver modes to each other. The resolution bandwidth (RBW) and filter type are set to the same value in the analyzer and receiver screens. Other settings, such as the quasipeak detector, may prevent these settings.

Example: "INST:COUP:BWID ALL"
Characteristics: *RST value: NONE
SCPI: device specific
Mode: R, A

INSTrument:COUPlE:CENTer ALL | NONE

This command couples the center frequency or receive frequency settings for the analyzer and receiver modes to each other.

Example: "INST:COUP:CENT ALL"
Characteristics: *RST value: ALL
SCPI: device specific
Mode: R, A

INSTrument:COUPlE:DEModulation ALL | NONE

This command couples the audio demodulator settings for the analyzer and receiver modes to each other.

Example: "INST:COUP:DEM ALL"
Characteristics: *RST value: NONE
SCPI: device specific
Mode: R, A

INSTrument:COUPlE:GAIN ALL | NONE

This command couples the preamplifier settings for the analyzer and receiver modes to each other.

Example: "INST:COUP:GAIN ALL"
Characteristics: *RST value: ALL
SCPI: device specific
Mode: R, A

INSTRUMENT:COUPLE:PRESelector ALL | NONE

This command couples the activation of preselection for the analyzer and receiver modes to each other.

Preselection cannot be switched off in the receiver mode. In practice, this means that preselection is always switched on automatically when changing to the analyzer mode with coupling activated.

Example: "INST:COUP:PRES ALL"

Characteristics: *RST value: ALL
SCPI: device specific

Mode: R, A

INSTRUMENT:COUPLE:PROTECTION ALL | NONE

This command couples the RF safety attenuation of 10 dB for the analyzer and receiver modes to each other.

To prevent damage to the RF input, switch on this coupling.

Example: "INST:COUP:PROT ALL"

Characteristics: *RST value: ALL
SCPI: device specific

Mode: R, A

INSTRUMENT:COUPLE:SPAN ALL | NONE

This command couples the start and stop frequencies of sweep and scan for the analyzer and receiver modes to each other.

Example: "INST:COUP:SPAN ALL"

Characteristics: *RST value: NONE
SCPI: device specific

Mode: R, A

MMEMory Subsystem

The MMEMory (mass memory) subsystem provides commands which allow for access to the storage media of the instrument and for storing and loading various instrument settings.

The various drives can be addressed via the "mass storage unit specifier" <msus> using the conventional DOS syntax. The internal hard disk is addressed by "D:", the floppy disk drive by "A:".

Note: For reasons of compatibility with the FSE instruments, addressing the hard disk by "C:" is also accepted. Since hard disk "C:" is reserved for instrument software, all read and write operations are rerouted to hard disk "D:" in normal operation (service level 0).

The file names <file_name> are indicated as string parameters with the commands being enclosed in quotation marks. They also comply with DOS conventions.

DOS file names consist of max. 8 ASCII characters and an extension of up to three characters separated from the file name by a dot "." Both, the dot and the extension are optional. The dot is not part of the file name. DOS file names do not distinguish between uppercase and lowercase notation. All letters and digits are permitted as well as the special characters "_", "^", "\$", "~", "!", "#", "%", "&", "-", "{", "}", "(", ")", "@", and "~". Reserved file names are CLOCK\$, CON, AUX, COM1 to COM4, LPT1 to LPT3, NUL and PRN.

The two characters "*" and "?" have the function of so-called "wildcards", i.e., they are variables for selection of several files. The question mark "?" replaces exactly one character, the asterisk means any of the remaining characters in the file name. "*.*" thus means all files in a directory.

COMMAND	PARAMETERS	UNIT	COMMENT
MMEMory			
:CATalog?	<string>		
:CDIRectory	<directory_name>	--	
:COPY	<file_name>,<file_name>	--	no query
:DATA	<file_name>[,<block>]	--	
:DELete	<file_name>	--	no query
:INITialize	<msus>	--	no query
:LOAD			
:STATe	1,<file_name>	--	no query
:AUTO	1,<file_name>	--	no query
:MDIRectory	<directory_name>	--	no query
:MOVE	<file_name>,<file_name>	--	no query
:MSIS	<msus>	--	
:NAME	<file_name>	--	
:RDIRectory	<directory_name>	--	no query
:STORe<1 2>			
:STATe		--	
:TRACe	1,<file_name>		no query
:FINal	<numeric_value>, <file_name>		
:CLEar	<file_name>		
:STATe			no query
:ALL	1,<file_name>		no query

COMMAND	PARAMETERS	UNIT	COMMENT
:SElect			
[:ITEM]			
:HWSettings	<Boolean>		
:TRACe			
[:ACTive]	<Boolean>		
:LINes			
:ALL	<Boolean>		
:SCData	<Boolean>		Tracking generator option
:TRANsducer			
:ALL	<Boolean>		
:FINal	<Boolean>		
:ALL	--		no query
:NONE	--		no query
:DEFault	--		no query
:COMMent	<string>		

MMEMemory:CATalog? <path>

This command reads the indicated directory. According to DOS convention, wild card characters can be entered in order to query e.g. a list of all files of a certain type.

The path name should be in conformance with DOS conventions and may also include the drive name.

Parameter: <path> ::= DOS Path name

Example: "MME:CAT? 'D:\USER\DATA' 'Returns the contents of the 'D:\USER\DATA directory
 "MME:CAT? 'D:\USER\DATA*.LOG' 'Returns all files in D:\USER\DATA 'with extension ".LOG"
 "MME:CAT? 'D:\USER\DATA\SPOOL?.WMF' 'Returns all files in D:\USER\DATA whose 'names start with SPOOL, have 6 letters 'and the extension ".WMF".

Response value: List of file names in the form of strings separated by commas, i.e. 'SPOOL1.WMF', 'SPOOL2.WMF', 'SPOOL3.WMF'

Characteristics: *RST value: -
 SCPI: device-specific

Operating mode: all

MMEMemory:CDIRectory <directory_name>

This command changes the current directory.

In addition to the path name, the indication of the directory may contain the drive name. The path name complies with the DOS conventions.

Parameter: <directory_name> ::= DOS path name

Example: "MME:CDIR 'D:\USER\DATA' " 'Returns the list of files in directory 'D:\USER\DATA.

Characteristics: *RST value: -
 SCPI: conforming

Mode: all

MMEMory:COPY <file_source>,<file_destination>

This command copies the files indicated in <file_source> to the destination directory indicated with <file_destination> or to the destination file indicated by <file_destination> when <file_source> is just a file.

The indication of the file name may include the path and the drive name. The file names and path information must be in accordance with the DOS conventions.

Parameter: <file_source>,<file_destination> ::= <file_name>
 <file_name> ::= DOS file name

Example: "MMEM: COPY 'D:\USER\DATA\SETUP.CFG', 'A: ' "

Characteristics: *RST value: -
 SCPI conforming

Mode: all

This command is an event and therefore has no *RST value and no query.

MMEMory:DATA <file_name>[,<block data>]

This command writes the block data contained in <block> into the file characterized by <file_name>. The IEC/IEEE-bus delimiter must be set to EOI to obtain error-free data transfer.

The associated query command reads the indicated file from the mass memory and transfers it to the control computer via the IEC/IEEE bus. It should be noted that the buffer memory of the control computer should be large enough to store the file. The setting of the IEC/IEEE-bus delimiter is irrelevant in this case.

The command is useful for reading stored device settings or trace data from the instrument or for transferring them to the instrument.

Syntax: MMEMory:DATA <file_name>,<block data> Data transfer from control computer to instrument.

MMEMory:DATA? <file_name> Data transfer from instrument to control computer.

<file_name> selects the file to be transferred.

The binary data block <block> has the following structure:

- it always begins with the character '#',
- followed by a digit for the length of the length information,
- followed by the indicated number of digits as length information (number of bytes) for the binary data themselves,
- finally the binary data with the indicated number of bytes

Example: "MMEM:DATA 'TEST01.HCP', #217This is the file"
 ' means:
 '#2: the next 2 characters
 ' are the length indication
 '17: number of subsequent binary data
 ' bytes
 'This is the file:
 ' 17 bytes stored as binary data in the
 ' file TEST01.HCP.

"MMEM:DATA? 'TEST01.HCP' " ' Transfers the file TEST01.HCP from the instrument to the control computer.

Characteristics: *RST value: -
 SCPI: conforming

Mode: all

MMEMory:DELeTe <file_name>

This command deletes the indicated files.

The indication of the file name contains the path and, optionally, the drive name. Indication of the path complies with DOS conventions.

Parameter: <file_name> ::= DOS file name

Example: "MMEM:DEL 'TEST01.HCP' " ' The file TEST01.HCP is deleted.

Characteristics: *RST value: -
SCPI: conforming

Mode: all

This command is an event and therefore has no *RST value and no query.

MMEMory:INITialize <msus>

This command formats the disk in drive A. Formatting deletes all data stored on the floppy disk.

Parameter: <msus> ::= 'A:' Only drive name A: is accepted.

Example: "MMEM:INIT 'A: ' "

Characteristics: *RST value: -
SCPI: conforming

Mode: all

This command is an event and therefore has no *RST value and no query.

MMEMory:LOAD:STATe 1,<file_name>

This command loads device settings from files. The contents of the file are loaded and set as the new device state. The device automatically recognizes the files that are required for the whole setup from the list of file extensions:

Contents	Extension
Current setting of measurement hardware and associated title, if indicated	.SET
Activated limit lines	.LIN
Current configuration of general device parameters	.CFG
Configuration for the hardcopy output	.HCS
User-defined color setting	.COL
All defined limit lines	.LIA
Measured data trace 1 to trace 3 screen A	.TR1 to 3
Measured data trace 1 to trace 3 screen B	.TR4 to 6
Tracking generator settings (only with Tracking Generator Option B9 or Ext. Generator Control B10)	.TCi
Setting for source calibration (only with Tracking Generator Option B9 or Ext. Generator Control B10)	.TS1 .TS2
Correction data for source calibration (only with Tracking Generator B9 or Ext. Generator Control B10)	.TC1; .TC2
Activated transducer factors	.TF
Activated transducer set	.TS
All defined transducer sets + transducer factors.	TSA; .TFA
Peak list or final measurement results	.FIN

The file name includes indication of the path and may also include the drive name. The path name complies with DOS conventions.

Parameter: <file_name> ::= DOS file name without extension, extensions see table

Example: "MMEM:LOAD:STAT 1, 'A:TEST' "

Characteristics: *RST value: -
SCPI: conforming

Mode: all

This command is an event and therefore has no *RST value and no query.

MMEMory:LOAD:AUTO 1,<file_name>

This command defines which device setting is automatically loaded after the device is switched on. The contents of the file are read after switching on the device and used to define the new device state. The file name includes indication of the path and may also include the drive. The path name complies with DOS conventions.

Note: *The data set defined as auto recall set will also be restored by a *RST-command.*

Parameter: <file_name> ::= DOS file name without extension;
 FACTORY denotes the data set previously in the instrument

Example: "MMEM:LOAD:AUTO 1, 'D:\USER\DATA\TEST' "

Characteristics: *RST value: FACTORY
 SCPI: device-specific

Mode: all

This command is an event and therefore has no *RST value and no query.

MMEMory:MDIRectory <directory_name>

This command creates a new directory. The file name includes indication of the path and may also include the drive name. The path name complies with DOS conventions.

Parameter: <directory_name> ::= DOS path name

Example: "MMEM:MDIR 'D:\USER\DATA' "

Characteristics: *RST value: -
 SCPI: device-specific

Mode: all

This command is an event and therefore has no *RST value and no query.

MMEMory:MOVE <file_source>,<file_destination>

This command renames existing files, if <file_destination> contains no path indication. Otherwise the file is moved to the indicated path and stored under the file name specified there, if any.

The file name includes indication of the path and may also include the drive. The path name complies with DOS conventions.

Parameter: <file_source>,<file_destination> ::= <file_name>
 <file_name> ::= DOS file name

Example: "MMEM:MOVE 'D:\TEST01.CFG', 'SETUP.CFG' "
 ' Renames TEST01.CFG in SETUP.CFG
 ' in directory D:\.

"MMEM:MOVE 'D:\TEST01.CFG', 'D:\USER\DATA' "
 ' Moves TEST01.CFG from D:\ to
 ' D:\USER\DATA.

"MMEM:MOVE 'D:\TEST01.CFG', 'D:\USER\DATA\SETUP.CFG' "
 ' Moves TEST01.CFG from D:\ to
 ' D:\USER\DATA and renames the file in
 ' SETUP.CFG.

Characteristics: *RST value: -
 SCPI: conforming

Mode: all

This command is an event and therefore has no *RST value and no query.

MMEMemory:MSIS <device>

This command changes to the drive indicated. The drive may be the internal hard disk D: or the floppy disk drive A:.

Example: "MME:MSIS 'A:' "
Characteristics: *RST value: "D:"
 SCPI: conforming
Mode: all

MMEMemory:NAME <file_name>

This command defines a destination file for the printout started with the command `HCOPY:IMMEDIATE`. In this case the printer output must be routed to destination *FILE* using the command "HCOP:DEST 'MME' ".

The file name includes indication of the path and may also include the drive name. The file name and path information comply with DOS conventions.

Parameter: <file_name> ::= DOS file name
Example: "HCOP:DEV:LANG BMP" Selection of data format.
 "HCOP:DEST 'MME' " Selection of the output device
 "MME:NAME 'PRINT1.BMP' " Selection of file name.
 "HCOP:IMM" Start of the printout.
Characteristics: *RST value: -
 SCPI: conforming
Mode: all

This command is an event and therefore has no *RST value and no query.

MMEMemory:RDIRectory <directory_name>

This command deletes the indicated directory. The directory name includes indication of the path and may also include the drive name. The path name complies with DOS conventions.

Parameter: <directory_name> ::= DOS path name
Example: "MME:RDIR 'D:\TEST' "
Characteristics: *RST value: -
 SCPI: device-specific
Mode: all

This command is an event and therefore has no *RST value and no query.

MMEMemory:STORe<1|2>:STATe 1,<file_name>

This command stores the current device settings in a series of files which have the indicated file name, but different extensions. The file name includes indication of the path and may also include the drive name. The path name complies with DOS conventions. The numeric suffix in `STORe<1|2>` is irrelevant with this command.

A list of the extensions used is contained under `MMEMemory:LOAD:STATe`.

Parameter: <file_name> := DOS file name without extension
Example: "MME:STOR:STAT 1, 'TEST' "
Characteristics: *RST value: -
 SCPI: conforming
Mode: all

This command is an event and therefore has no *RST value and no query.

MMEMory:STORe<1|2>:TRACe 1 to 3,<file_name>

This command stores the selected trace (1 to 3) in the measurement window indicated by STORe<1|2> (screen A or B) in a file with ASCII format. The file format is described in chapter 4 in the TRACE menu under the *ASCII-FILE EXPORT* softkey.

The decimal separator (decimal point or comma) for floating-point numerals contained in the file is defined with the command *FORMat:DEXPort:DSEParator*.

The file name includes indication of the path and the drive name. Indication of the path complies with DOS conventions.

Parameter: 1 to 3 := selected measurement curve Trace 1 to 3
<file_name> := DOS file name

Example: "MMEM:STOR2:TRAC 3, 'A:\TEST.ASC' "
' Stores trace 3 from screen B in the file
'TEST.ASC on a disk.

Characteristics: *RST value: -
SCPI: device-specific

Mode: all

This command is an event and therefore has no *RST value and no query.

:MMEMory:STORe:FINal <file_name>

This command stores the final measurement data in an ASCII file.

The file name includes indication of the path and may also include the drive. The path name corresponds to the DOS conventions.

Parameter: <file_name> := DOS file name

Example: ":MMEM:STOR:FIN 'A:\TEST.ASC' "

Characteristics: *RST value: -
SCPI: device-specific

Mode: R

This command is an event and therefore has no *RST value and no query.

MMEMory:CLEar:STATe 1,<file_name>

This command deletes the instrument setting selected by <file_name>. All associated files on the mass memory storage are cleared. A list of the extensions used is included under *MMEMory:LOAD:STATe*.

The file name includes indication of the path and may also include the drive. The path name complies with DOS conventions.

Parameter: <file_name> ::= DOS file name without extension

Example: "MMEM:CLE:STAT 1, 'TEST' "

Characteristics: *RST value: -
SCPI: device-specific

Mode: all

This command is an event and therefore has no *RST value and no query.

MMEMory:CLEar:ALL

This command deletes all device settings in the current directory. The current directory can be selected with `MMEM:CDIR`. The default directory is D:.

Example: "MMEM:CLE:ALL"

Characteristics: *RST value: -
SCPI: device-specific

Mode: all

This command is an event and therefore has no *RST value and no query.

MMEMory:SElect[:ITEM]:HWSSettings ON | OFF

This command includes the hardware settings in the list of data subsets of a device setting to be stored/loaded. The hardware settings include:

- current configuration of general device parameters (general setup)
- current setting of the measurement hardware including markers
- activated limit lines:
A data set may include 8 limit lines at maximum in each measurement window. This number includes the activated limit lines and, if available, the de-activated limit lines last used. Therefore the combination of the non-activated restored limit lines depends on the sequence of use with the command `MMEM:LOAD`.
- user-defined color setting
- configuration for the hardcopy output
- the activated transducers:
A data set may include 4 transducer factors at maximum. It comprises the activated factors and, if available, the de-activated factors last used. Therefore the combination of non-activated restored transducer factors depends on the sequence of use with the command `MMEM:LOAD`.
- Tracking generator settings
(only in conjunction with option Tracking Generator B9 or External Generator Control B10)
- Correction data for source calibration
(only in conjunction with option Tracking Generator B9 or External Generator Control B10)

Example: "MMEM:SEL:HWS ON"

Characteristics: *RST value: ON
SCPI: device-specific

Mode: all

MMEMory:SElect[:ITEM]:TRACe[:ACTive] ON | OFF

This command adds the active traces to the list of data subsets of a save/recall device setting. Active traces are all traces whose state is not blank.

Example: "MMEM:SEL:TRAC ON"

Characteristics: *RST value: OFF, i.e. no traces will be stored
SCPI: device-specific

Mode: all

MMEMory:SElect[:ITEM]:LINEs:ALL ON | OFF

This command adds all limit lines (activated and de-activated) to the list of device settings to be stored/loaded.

Example: "MMEM:SEL:LIN:ALL ON"
Characteristics: *RST value: ON
 SCPI: device-specific
Mode: all

MMEMory:SElect[:ITEM]:FINal ON | OFF

This command includes the final measurement data or the peak list in the list of partial datasets of a device setting to be stored/loaded.

Example: "MMEM:SEL:FIN ON" 'inserts the final measurement data in the list of partial 'data sets
Characteristics: *RST value: ON
 SCPI: device-specific
Modes: all

MMEMory:SElect[:ITEM]:SCData ON | OFF

This command adds the tracking generator calibration data to the list of device settings to be stored/loaded.

Example: "MMEM:SEL:SCD ON" 'Inserts the tracking generator correction data 'in the list of data subsets
Characteristics: *RST value: OFF
 SCPI: device-specific
Modes: all

This command is only available in conjunction with the tracking generator option R&S FSP-B9 or external generator control option R&S FSP-B10.

MMEMory:SElect[:ITEM]:TRANsducer:ALL ON | OFF

This command includes all transducer factors and sets in the list of data subsets of a device setting to be stored/loaded.

Example: "MMEM:SEL:TRAN:ALL ON"
Characteristics: *RST value: ON
 SCPI: device-specific
Modes: all

MMEMory:SElect[:ITEM]:ALL

This command includes all data subsets in the list device settings to be stored/loaded.

Example: "MMEM:SEL:ALL"
Characteristics: *RST value: --
 SCPI: device-specific
Mode: all

This command is an event and therefore has no *RST value.

MMEMory:SElect[:ITEM]:NONE

This command deletes all data subsets from the list of device settings to be stored/loaded.

Example: "MMEM:SEL:NONE"

Characteristics: *RST value: --
SCPI: device-specific

Mode: all

This command is an event and therefore has no *RST value.

MMEMory:SElect[:ITEM]:DEFault

This command sets the default list of device settings to be stored/loaded. The latter includes:

- current configuration of general device parameters (general setup)
- current setting of the measurement hardware including markers
- activated limit lines
- user-defined color setting
- configuration for the hardcopy output
- Tracking generator settings
(only in conjunction with option Tracking Generator R&S FSP-B9 or External Generator Control R&S FSP-B10)
- Correction data for source calibration
(only in conjunction with option Tracking Generator R&S FSP-B9 or External Generator Control R&S FSP-B10)

Trace data, non-used transducer factors/sets and non-used limit lines are not included.

Example: "MMEM:SEL:DEFault"

Characteristics: *RST value: --
SCPI: device-specific

Mode: all

This command is an event and therefore has no *RST value.

MMEMory:COMMeNT <string>

This command defines a comment (max. 60 characters) for a device setting to be stored.

Example: "MMEM:COMM 'Setup for GSM measurement'"

Characteristics: *RST value: blank comment
SCPI: device-specific

Mode: all

OUTPut Subsystem

The OUTPut subsystem controls the output features of the instrument. In conjunction with the tracking generator option, a distinction is made between OUTPut1 (screen A) and OUTPut2 (screen B).

COMMAND	PARAMETERS	UNIT	COMMENT
OUTPut<1 2> [:STATe] :UPORt [:VALue] :STATe	<Boolean> <binary> <Boolean>	-- -- --	Tracking generator option

OUTPut<1|2>[:STATe] ON | OFF

This command switches the tracking generator on or off.

- Notes:**
- With the tracking generator switched on, the maximum stop frequency is limited to 3 GHz. This upper limit is automatically modified by the set frequency offset of the generator.
 - If measurements in compliance with specs are to be performed with the tracking generator, the start frequency has to be $\geq 3 \times$ resolution bandwidth.
 - The minimum sweep time for measurements in compliance with the data sheet is 100 ms in the frequency domain (span >0). If a shorter sweep time is selected, the sweep time indicator SWT on the screen is marked with a red asterisk and the message UNCAL is also displayed.
 - With the tracking generator switched on, the FFT filters (BAND:MODE:FFT) are not available.

Example: "OUTP ON" 'Switches on the tracking generator in screen A.

Characteristics: *RST value: -
SCPI: conforming

Modes: A

This command is only valid in conjunction with option tracking generator.

OUTPut:UPORt[:VALue] #B00000000 to #B11111111

This command sets the control lines of the user ports. In manual operation, the control lines are represented by softkeys PORT 0 to 7.

The user port is written to with the given binary pattern. If the user port is programmed to INPut instead of OUTPut, the output value is temporarily stored.

Example: "OUTP:UPOR #B10100101"

Characteristics: *RST value: -
SCPI: device-specific

Modes: all

OUTPut:UPORt:STATe ON | OFF

This command switches the control line of the user ports between INPut and OUTPut.

The user port is switched to OUTPut with parameter ON, to INPut with OFF.

Example: "OUTP:UPOR:STAT ON"

Characteristics: *RST value: OFF
SCPI: device-specific

Modes: all

SENSe Subsystem

The SENSe subsystem is organized in several subsystems. The commands of these subsystems directly control device-specific settings, they do not refer to the signal characteristics of the measurement signal.

The SENSe subsystem controls the essential parameters of the receiver. In accordance with the SCPI standard, the keyword "SENSe" is optional for this reason, which means that it is not necessary to include the SENSe node in command sequences.

The measurement windows are selected by SENSe1 and SENSe2:

SENSe1 = Modification of screen A settings
SENSe2 = Modification of screen B settings.

Screen A is automatically selected if 1 or 2 is missing.

In the receiver mode, the screen partitioning for the split-screen mode is fixed – bargraph at top and scan display below. Therefore, the numeric suffix is not required to select the measurement window.

[SENSe:]ADEMod - Subsystem

The purpose of the commands defined below is to set up the instrument for the measurement of FM, PM and AM modulated signals in a way that allows to obtain as many measurement results as possible with a single shot measurement.

For that purpose the instrument has been equipped with a demodulator that is capable of performing both FM, PM and AM demodulation at a time. Additionally maximum, minimum and average or current values can be obtained in parallel over a selected number of measurements. In order to make it suitable for burst signals the demodulator can be configured in terms of pretrigger time, sample rate and record length.

Note: Demodulation will be performed offline, that means, on signals previously stored into memory. The I/Q memory available for that purpose is 2 x 128 k samples. The sample rate can be selected in the range of 15.625 kHz to 32 MHz.

Example:

For a Bluetooth signal, the signal schematic under request is described in the following diagram:

Frequency versus time:

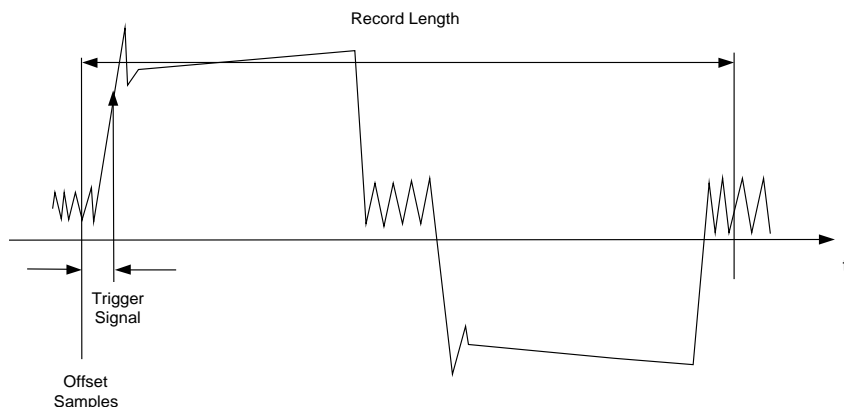

Measurement results of interest are:

- FM Offset
- FM Deviation (maximum and minimum) for signal modulated with '1'-values only

- FM Deviation (maximum and minimum) for signal modulated with '0'-values only
- AM Modulation Depth for positive and negative burst ramp.

These values can be obtained by external computations on the frequency or amplitude versus time data. For that purpose the R&S ESCI will deliver the following results:

- Demodulated FM signal (current values, averaged, maxhold, minhold selectable)
- Demodulated AM component of the signal (current values, averaged, maxhold, minhold selectable)
- FM Offset (current value or averaged selectable)

Therefore parameters to be set up on the analyzer are:

- types of demodulation to measure simultaneously (AM/FM)
- sample rate
- record length
- trigger source (free Run/external)
- pretrigger samples
- # of measurements to use for average/maxhold/minhold

Additionally for each demodulation type the required result values need to be configured. The R&S ESCI is capable to perform two modulation types at a time with a maximum of 3 different result types per demodulation. Possible selections for the result types are

- WRITeThe current measurement results will be obtained
- AVERAgeThe measurement results will be averaged over the given # of measurements
- MAXHoldThe maximum result values will be obtained over the given # of measurements
- MINHoldThe minimum result values will be obtained over the given # of measurements

The commands defined below will be used in the following way:

Setting up the instrument and querying the result list after synchronization to the end of measurement: With this method the control computer can be used for other activities while the R&S ESCI is performing the measurement.

Note: *Analog demodulation is only available for screen A. Therefore the command sequence "SENSe2..." is not available for the commands of the SENSe:ADEMod subsystem.*

COMMAND	PARAMETERS	UNIT	COMMENT
[SENSe<1 2>] :ADEMod :AF			Option FM Demodulator
:COUPling	AC DC		
:CENTer	<numeric_value>		
:SPAN	<numeric_value>	HZ	
:FULL	--	HZ	
:STARt	<numeric_value>	--	
:STOP	<numeric_value>	HZ	
:BANDwidth		HZ	
:DEModulation	<numeric_value>		
:BWIDth		HZ	
:DEModulation	<numeric_value>		
:MTIMe	<numeric_value>	HZ	
:RLENgth?		S	
[:STATE]	<Boolean>		query only
:SET	<numeric_value>, <numeric_value>, IMMediate EXTernal, POSitive NEGative, <numeric_value>, <numeric_value>	HZ, --, --, --, --, --	

COMMAND	PARAMETERS	UNIT	COMMENT
:SRATe?			query only
:AM			
[:TDOMain]	WRITe AVERAge MAXHold MINHold OFF,		
[:TYPE]	WRITe AVERAge MAXHold MINHold OFF,		
	WRITe AVERAge MAXHold MINHold OFF		
	WRITe AVERAge MAXHold MINHold		
:RESult?			
:AFSPectrum			
[:TYPE]	WRITe AVERAge MAXHold MINHold OFF,		
	WRITe AVERAge MAXHold MINHold OFF,		
	WRITe AVERAge MAXHold MINHold OFF		
	WRITe AVERAge MAXHold MINHold		
:RESult?			
:FM			
[:TDOMain]	WRITe AVERAge MAXHold MINHold OFF,		
[:TYPE]	WRITe AVERAge MAXHold MINHold OFF,		
	WRITe AVERAge MAXHold MINHold OFF		
	WRITe AVERAge MAXHold MINHold		
:RESult?			
:AFSPectrum			
[:TYPE]	WRITe AVERAge MAXHold MINHold OFF,		
	WRITe AVERAge MAXHold MINHold OFF,		
	WRITe AVERAge MAXHold MINHold OFF		
	WRITe AVERAge MAXHold MINHold	HZ	
:RESult?	IMMediate AVERAge	HZ	
:OFFSet?		HZ	
:PM			
[:TDOMain]	WRITe AVERAge MAXHold MINHold VIEW OFF,		
[:TYPE]	WRITe AVERAge MAXHold MINHold VIEW OFF,		
	WRITe AVERAge MAXHold MINHold VIEW OFF		
	WRITe AVERAge MAXHold MINHold		
:RESult?			
:AFSPectrum			
[:TYPE]	WRITe AVERAge MAXHold MINHold OFF,		
	WRITe AVERAge MAXHold MINHold OFF,		
	WRITe AVERAge MAXHold MINHold OFF		
	WRITe AVERAge MAXHold MINHold	S	
:RESult?			
:SPECtrum	<numeric_value>		
:BANDwidth			
[:RESolution]	<numeric_value>		
:BWIDth	<numeric_value>		
[:RESolution]	<numeric_value>		
:SPAN	<numeric_value>		
[:MAXimum]	<numeric_value>		
:ZOOM			
[:TYPE]	WRITe AVERAge MAXHold MINHold VIEW OFF,		
	WRITe AVERAge MAXHold MINHold VIEW OFF,		
	WRITe AVERAge MAXHold MINHold VIEW OFF		
	WRITe AVERAge MAXHold MINHold		
:RESult?			
:ZOOM	<Boolean>		
[:STATe]	<numeric_value>		
:START			

[SENSe:]ADEMod:AF:COUPLing AC | DC

This command selects the coupling of the AF path of the analyzer.

Example: "ADEM:AF:COUP DC" 'Switches on DC coupling.

Characteristics: *RST value: AC
SCPI: device-specific

Mode: A

This command is only available with option R&S FS-K7 (FM Demodulator).

[SENSe:]ADEMod:AF:SPAN <numeric_value>

This command sets the span for result display AF spectrum.

The span is limited to half the measurement bandwidth of analog demodulation (SENS:ADEM:BAND).

Example: "ADEM ON" 'Switches on the FM demodulator
"CALC:FEED 'XTIM:FM:AFSP" 'Switches on result display AF spectrum of FM or
"CALC:FEED 'XTIM:RFP:AFSP" 'Switches on result display AF spectrum of RF power signal
"ADEM:BAND 5 MHz" 'Sets the measurement bandwidth to 5 MHz
"ADEM:AF:CENT 500kHz" 'Sets the AF center frequency to 500 kHz
"ADEM:AF:SPAN 200kHz" 'Sets the AF span to 200 kHz

Characteristics: *RST value: 2.5 MHz
SCPI: device-specific

Mode: FM

This command is only available with option R&S FS-K7 (FM demodulator).

[SENSe:]ADEMod:AF:SPAN:FULL

This command sets the maximum span for result display AF spectrum.

The maximum span corresponds to half the measurement bandwidth of analog demodulation (SENS:ADEM:BAND).

Example: "ADEM ON" 'Switches on the FM demodulator
"CALC:FEED 'XTIM:FM:AFSP" 'Switches on result display AF spectrum of FM or
"CALC:FEED 'XTIM:RFP:AFSP" 'Switches on result display AF spectrum of RF power signals
"ADEM:BAND 5 MHz" 'Sets the measurement bandwidth to 5 MHz
"ADEM:AF:SPAN:FULL" 'Sets the AF span to 2.5 MHz

Characteristics: *RST value: -
SCPI: device-specific

Mode: FM

This command is only available with option R&S FS-K7 (FM demodulator).

[SENSe:]ADEMod:AF:CENTer <numeric_value>

This command sets the center frequency for result display AF spectrum.

Example:

"ADEM ON"	'Switches on the FM demodulator
"CALC:FEED XTIM:FM:AFSP"	'Switches on result display AF spectrum of FM or
"CALC:FEED XTIM:RFP:AFSP"	'Switches on result display AF spectrum of RF power signal
"ADEM:BAND 5 MHz"	'Sets the measurement bandwidth to 5 MHz
"ADEM:AF:CENT 500kHz"	'Sets the AF center frequency to 500 kHz
"ADEM:AF:SPAN 200kHz"	'Sets the AF span to 200 kHz

Characteristics: *RST value: 1.25 MHz
SCPI: device-specific

Mode: FM

This command is only available with option R&S FS-K7 (FM demodulator).

[SENSe:]ADEMod:AF:START <numeric_value>

This command sets the start frequency for result display AF spectrum.

Example:

"ADEM ON"	'Switches on FM demodulator
"CALC:FEED XTIM:FM:AFSP"	'Switches on result display AF spectrum of FM or
"CALC:FEED XTIM:RFP:AFSP"	'Switches on result display AF spectrum of RF power signal
"ADEM:BAND 5 MHz"	'Sets the measurement bandwidth to 5 MHz
"ADEM:AF:STAR 0kHz"	'Sets the AF start frequency to 0 kHz
"ADEM:AF:STOP 500kHz"	'Sets the AF stop frequency to 500 kHz

Characteristics: *RST value: 0 MHz
SCPI: device-specific

Mode: FM

This command is only available with option R&S FS-K7 (FM demodulator).

[SENSe:]ADEMod:AF:STOP <numeric_value>

This command sets the stop frequency for result display AF spectrum.

The stop frequency is limited to half the measurement bandwidth of analog demodulation (SENS:ADEM:BAND).

Example:

"ADEM ON"	'Switches on the FM demodulator
"CALC:FEED XTIM:FM:AFSP"	'Switches on result display AF spectrum of FM or
"CALC:FEED XTIM:RFP:AFSP"	'Switches on result display AF spectrum of RF power signal
"ADEM:BAND 5 MHz"	'Sets the measurement bandwidth to 5 MHz
"ADEM:AF:STAR 0kHz"	'Sets the AF start frequency to 0 kHz
"ADEM:AF:STOP 500kHz"	'Sets the AF stop frequency to 500 kHz

Characteristics: *RST value: 2.5 MHz
SCPI: device-specific

Mode: FM

This command is only available with option R&S FS-K7 (FM demodulator).

[SENSe:]ADEMod:BANDwidth | BWIDth:DEModulation <numeric_value>

This command defines the demodulation bandwidth used for analog demodulation. The required sampling rate is automatically set depending on the selected demodulation bandwidth. The available demodulation bandwidths are determined by the existing sampling rates.

Rounded demodulation bandwidth	Sampling rate
10 MHz	32 MHz
8 MHz	16 MHz
5 MHz	8 MHz
3 MHz	4 MHz
1.6 MHz	2 MHz
800 kHz	1 MHz
400 kHz	500 kHz
200 kHz	250 kHz
100 kHz	125 kHz
50 kHz	62.5 kHz
25 kHz	31.25 kHz
12.5 kHz	15.625 kHz

Example: "ADEM:BAND:DEM 1MHz "

'Sets the demodulation bandwidth to 1 MHz.

Characteristics: *RST value: 5 MHz
SCPI: device-specific

Mode: FM

This command is only available with option R&S FS-K7 (FM Demodulator).

[SENSe:]ADEMod:MTIME <numeric_value>

This command defines the measurement time for analog demodulation.

Example: "ADEM:BAND:MTIM 62.625us " 'Sets the measurement time to 62.625 μ s.

Characteristics: *RST value: 62.625us
SCPI: device-specific

Mode: FM

This command is only available with option R&S FS-K7 (FM Demodulator).

[SENSe:]ADEMod:RLENGTH?

This command returns the record length set up for the current analog demodulation measurement.

Example: "ADEM:RLEN? " 'Returns the current record length.

Characteristics: *RST value: -
SCPI: device-specific

Mode: FM

This command is only available with option R&S FS-K7 (FM Demodulator).

[SENSe:]ADEMod[:STATe] ON | OFF

This command activates the FM demodulator of the instrument. The instrument will be set to time domain measurement (span = 0) at the current center frequency. The detector will be set to SAMPLE, the demodulator itself will be set up according to the parameters of command [SENSe:]ADEMod:SET.

Note: *The measurement is always performed in Screen A. Split Screen operation will be switched off as soon as the Demodulator is activated.*

Example: "ADEM ON" 'Switches the AM/FM demodulator on with the parameters set by [SENSe:]ADEMod:SET.

Characteristics: *RST value: OFF
SCPI: device-specific

Mode: FM

This command is only available with option R&S FS-K7 (FM Demodulator).

[SENSe:]ADEMod:SET <sample rate>,<record length>, <trigger source>,<trigger slope>,<offset samples>,<# of meas>

This command configures the AM/FM demodulator of the instrument.

Parameters:

- <sample rate>: The frequency at which measurement values are taken from the A/D-converter and stored in I/Q memory.
Valid range: 15.625 kHz, 31.25 kHz, 62.5 kHz, 125 kHz, 250 kHz, 500 kHz, 1 MHz, 2 MHz, 4 MHz, 8 MHz, 16 MHz, 32 MHz with <filter type> = NORMal
- <record length>: Number of samples to be stored in I/Q memory. Valid range: 1 to 130560 (128 * 1024 - 512)
- <trigger source>: Selection of the trigger source to use for the demodulator.
Valid values: IMMEDIATE | EXTERNAL | IFPOWER | RFPower | AF | AM | FM | PM
- <trigger slope>: Used slope of the trigger signal.
Valid values: POSITIVE | NEGATIVE
The value indicated here will be ignored for <trigger source> = IMMEDIATE.
- <offset samples>: Number of samples to be used as an offset to the trigger signal.
Valid range: -65024 to 130559 (= -64 * 1024 + 512 to 128 * 1024 - 513)
The value indicated here will be ignored for <trigger source> = IMMEDIATE.
- <# of meas>: Number of repetitions of the measurement to be executed. The value indicated here is especially necessary for the average/maxhold/minhold function. Valid range: 0 to 32767

Examples: ADEM:SET 8MHz,32000,EXT,POS,-500,30
' Executes a measurement at sample rate= 8 MHz
record length= 32000; trigger source = EXTERNAL
trigger slope = POSITIVE; offset samples = -500 (= 500 samples before trigger occurred); # of meas = 30

Characteristics: *RST values: sample rate= 8 MHz
record length= 501
trigger source = IMMEDIATE
trigger slope = POSITIVE
offset samples = 0
of meas = 0

SCPI: device-specific

Mode: FM

This command is only available with option R&S FS-K7 (FM Demodulator).

[SENSe:]ADEMod:SRATe?

This command returns the sample rate set up for the current analog demodulation measurement.

Example: "ADEM:SRAT?" 'Returns the current sample rate.

Characteristics: *RST value: -
SCPI: device-specific

Mode: FM

This command is only available with option R&S FS-K7 (FM Demodulator).

[SENSe:]ADEMod:AM[:TDOMain][:TYPE] <result type 1>,<result type 2>,<result type 3>

This command selects the result types to be created in parallel by AM demodulation.

Parameters:	<result type 1/2/3>	WRITE	The current measurement results will be obtained
		AVERage	The measurement results will be averaged over the given # of measurements
		MAXHold	The maximum result values will be obtained over the given # of measurements
		MINHold	The minimum result values will be obtained over the given # of measurements
		VIEW	The measurement results are frozen and displayed, i.e. they are not calculated for subsequent measurements.
		OFF	The result type will not be used.

Notes:

*Each value besides OFF can only be assigned to one result type at a time.
Setting all result types to OFF will deactivate the AM demodulator.*

Examples:	ADEM:AM AVER,MAXH,MINH	'Creates average, max hold and min hold values at 'a time
	ADEM:AM WRIT,OFF,OFF	'Creates only the current measurement values
	ADEM:AM OFF,OFF,OFF	'Switches AM demodulation off

Characteristics: *RST values: WRITE,OFF,OFF
SCPI: device-specific

Mode: A

This command is only available with option R&S FS-K7 (FM Demodulator).

[SENSe:]ADEMod:AM[:TDOMain]:RESult?<result type>

This command reads the result data obtained by AM demodulation depending on the type indicated as a parameter. The data format of the output data block is defined by the FORMat command.

Note: *It is not possible to read out trace data when result type VIEW is selected.*

Parameters: <result type>: WRITe The current measurement results will be obtained
 AVERage The measurement results will be averaged over the given # of measurements
 MAXHold The maximum result values will be obtained over the given # of measurements
 MINHold The minimum result values will be obtained over the given # of measurements

Notes: *The result type indicated must be one of those configured by [SENSe:]ADEMod:AM[:TDOMain][:TYPE]. Otherwise a query error will be generated.*

Return Values:**ASCII Format (FORMat ASCII):**

In this case the command will yield a list of comma separated values (CSV) of the measured values in floating point format. The output unit is dBm *with logarithmic display and V with linear display.*

Binary Format (FORMat REAL,32):

In this case the command will yield binary data (Definite Length Block Data according to IEEE 488.2), each measurement value being formatted in 32 Bit IEEE 754 Floating-Point-Format. The schematics of the result string will be as follows:

#41024<value1><value2>...<value n>

with

#4 number of digits (= 4 in the example) of the following number of data bytes
 1024 number of following data bytes (= 1024 in the example)
 <value x> 4-Byte-Floating Point Value

Examples:

ADEM:SET 8MHz,32000,EXT,POS,-500,30	'Sets up demodulator parameters
ADEM:FM AVER,MAXH,MINH	'Sets up FM results to measure
ADEM:AM WRIT,OFF,OFF	'Sets up AM results to measure
ADEM ON	'Switches on demodulator
INIT;*WAI	'Starts measurement and waits for sync
FORM ASC	'Selects output format
ADEM:FM:RES? AVER	'Reads FM average results
ADEM:FM:RES? MAXH	'Reads FM max hold results
ADEM:FM:RES? MINH	'Reads FM min hold results
ADEM:AM:RES? WRIT	'Reads AM current results

Characteristics: *RST values: -
 SCPI: device-specific

Mode: FM

This command is only available with option R&S FS-K7 (FM Demodulator).

[SENSe:]ADEMod:AM:AFSPectrum[:TYPE] <result type 1>,<result type 2>,<result type 3>

This command selects the simultaneously measured result types of the AF spectrum of the AM demodulated signal.

Parameter:	<result type 1/2/3>:	WRITE	The current measurement results are recorded.
		AVERage	The measurement results averaged over the given number of measurements are obtained.
		MAXHold	The maximum result is determined over the given number of measurements.
		MINHold	The minimum result is determined over the given number of measurements.
		VIEW	The measurement result in the display is frozen, i.e. not recalculated with further measurements.
		OFF	Result type is not used.

Note:

Settings other than OFF can be assigned only to one result type at a time.

If all result types are set to OFF, the AF spectrum of the AM demodulated signal is not calculated.

The result type "AF spectrum of AM demodulated signal" cannot be activated at the same time as "AF spectrum of FM demodulated signal".

Examples:

ADEM:AM:AFSP	AVER , MAXH , MINH	'Determines average, maximum and minimum value simultaneously
ADEM:AM:AFSP	WRIT , OFF , OFF	'Determines only current measurement results
ADEM:AM:AFSP	OFF , OFF , OFF	'Switches off calculation of the AF spectrums

Characteristics: *RST values: OFF,OFF,OFF
SCPI: device-specific

Mode: A

This command is only available with option R&S FS-K7 (FM demodulator).

[SENSe:]ADEMod:AM:AFSPectrum:RESult? <result type>

This command reads out measurement results of the AF spectrum of the AM demodulated signal with the specified result type. The data format of the output data is determined with the FORMat command.

Note: Traces in the VIEW state cannot be queried.

Parameter:	<result type>:	WRITe	The current measurement results are returned.
		AVERage	The measurement results averaged over the given number of measurements are returned.
		MAXHold	The maximum result determined over the given number of measurements is returned.
		MINHold	The minimum result determined over the given number of measurements is returned.

Note:

The specified result type must be one of those configured with command [SENSe:]ADEMod:AM:AFSPectrum[:TYPE]. Otherwise a query error will be generated.

Returned values:

ASCII format (FORMat ASCII):

In this case, the command returns a comma-separated list (comma separated values = CSV) of the measured values in floating-point format. The output unit is dBm with logarithmic display and volt with linear display.

Binary format (FORMat REAL,32):

In this case the command returns binary data (definite length block data to IEEE 488.2), each measured value being formatted in 32-bit IEEE 754 floating point format. When seen schematically, the return string is structured as follows:

```
#41024<value1><value2>...<value n>
with
#4                               number of digits (4 in the example) of the following number of
data bytes
1024                             number of following data bytes (# of DataBytes, 1024 in the example)
<value x> 4-byte floating point value
```

Examples:

```
ADEM:SET 8MHz,32000,EXT,POS,-500,30 'Sets the demodulator
ADEM:FM AVER,MAXH,MINH             'Selects the FM results to be measured
ADEM:AM WRIT,OFF,OFF               'Selects the AM results to be measured
ADEM:AM:AFSP WRIT,OFF,OFF         'Selects the AF spectrum results of the
demodulated AM signal to be measured.
ADEM ON                             'Switches on the demodulator
INIT;*WAI                          'Starts the measurement and waits for the
termination
FORM ASC                             'Selects the output format
ADEM:FM:RES? AVER                  'Reads the FM average results data
ADEM:FM:RES? MAXH                  'Reads the FM Maxhold result data
ADEM:FM:RES? MINH                  'Reads the FM Minhold result data
ADEM:AM:RES? WRIT                  'Reads the current AM results
ADEM:AM:AFSP:RES? WRIT            'Reads the current AF spectrum result data
of the demodulated AM signal
```

Characteristics: *RST value: -
SCPI: device-specific

Mode: FM

This command is only available with option R&S FS-K7 (FM demodulator).

[SENSe:]ADEMod:FM[:TDOMain][:TYPE]<result type 1>,<result type 2>,<result type 3>

This command selects the result types to be created in parallel by FM demodulation.

- Parameters:** <result type 1/2/3>:
- WRITE** The current measurement results will be obtained
 - AVERAge** The measurement results will be averaged over the given # of measurements
 - MAXHold** The maximum result values will be obtained over the given # of measurements
 - MINHold** The minimum result values will be obtained over the given # of measurements
 - VIEW** The measurement results are frozen and displayed, i.e. they are not calculated for subsequent measurements.
 - OFF** The result type will not be used.

Notes: *Each value besides OFF can only be assigned to one result type at a time. Setting all result types to OFF will deactivate the FM demodulator.*

- Examples:**
- ADEM:FMAVER,MAXH,MINH 'Creates average, max hold and min hold values 'at a time
 - ADEM:FMWRIT,OFF,OFF 'Only creates the current measurement values
 - ADEM:FMOFF,OFF,OFF 'Switches FM demodulation off

Characteristics: *RST values: WRITE,OFF,OFF
SCPI: device-specific

Mode: FM

This command is only available with option R&S FS-K7 (FM Demodulator).

[SENSe:]ADEMod:FM[:TDOMain]:RESult? <result type>

This command reads the result data obtained by FM demodulation depending on the type indicated as a parameter. The data format of the output data block is defined by the FORMat command.

Note: *It is not possible to read out trace data when result type VIEW is selected.*

Parameters: <result type>: WRITe The current measurement results will be obtained
 AVERage The measurement results will be averaged over the given # of measurements
 MAXHold The maximum result values will be obtained over the given # of measurements
 MINHold The minimum result values will be obtained over the given # of measurements

Notes: *The result type indicated must be one of those configured by [SENSe:]ADEMod:FM[:TDOMain][:TYPE]. Otherwise a query error will be generated.*

Return Values**ASCII Format (FORMat ASCII):**

In this case the command will yield a list of comma separated values (CSV) of the measured values in floating point format. The output unit is Hz.

Binary Format (FORMat REAL,32):

In this case the command will yield binary data (Definite Length Block Data according to IEEE 488.2), each measurement value being formatted in 32 Bit IEEE 754 Floating-Point-Format. The schematics of the result string will be as follows:

#41024<value1><value2>...<value n>

with

#4 number of digits (= 4 in the example) of the following number of data bytes

1024 number of following data bytes (= 1024 in the example)

<value x> 4-Byte-Floating Point Value

Examples:

ADEM:SET 8MHz,32000,EXT,POS,-500,30	'Sets up demodulator parameters
ADEM:FM AVER,MAXH,MINH	'Sets up FM results to measure
ADEM:AM WRIT,OFF,OFF	'Sets up SPEC results to measure
ADEM ON	'Switches on demodulator
INIT;*WAI	'Starts measurement and waits
	'for sync
FORM ASC	'Selects output format
ADEM:FM:RES? AVER	'Reads FM average results
ADEM:FM:RES? MAXH	'Reads FM max hold results
ADEM:FM:RES? MINH	'Reads FM min hold results
ADEM:AM:RES? WRIT	'Reads AM current results

Characteristics: *RST values: -
 SCPI: device-specific

Mode: FM

This command is only available with option R&S FS-K7 (FM Demodulator).

[SENSe:]ADEMod:FM:AFSPectrum[:TYPE] <result type 1>,<result type 2>,<result type 3>

This command selects the simultaneously measured result types of the AF spectrum of the FM demodulated signal.

Parameter:	<result type 1/2/3>:	WRITe	The current measurement results are recorded.
		AVERage	The measurement results averaged over the given number of measurements are obtained.
		MAXHold	The maximum result is determined over the given number of measurements.
		MINHold	The minimum result is determined over the given number of measurements.
		VIEW	The measurement result in the display is frozen, i.e. it is not recalculated in further measurements.
		OFF	The result type is not used.

Note:

Settings other than OFF can be assigned only to one result type at a time.

If all result types are set to OFF, the AF spectrum of the FM demodulated signal is not calculated.

The result type "AF spectrum of the FM demodulated signal" cannot be activated at the same time as "AF spectrum of AM demodulated signal".

Examples:

ADEM:FM:AFSP	AVER,MAXH,MINH	'Determines average, maximum and minimum value simultaneously
ADEM:FM:AFSP	WRIT,OFF,OFF	'Determines only current measurement results
ADEM:FM:AFSP	OFF,OFF,OFF	'Switches calculation of AF spectrum off

Characteristics: *RST values: OFF,OFF,OFF
SCPI: device-specific

Mode: A

This command is only available with option R&S FS-K7 (FM demodulator).

[SENSe:]ADEMod:FM:AFSPectrum:RESult? <result type>

This command reads out measurement results of the AF spectrum of the FM demodulated signal with the specified result type. The data format of the output data is determined with the FORMat command.

Note: *Traces in the VIEW state cannot be queried.*

Parameter: <result type>: WRITe The current measurement results are returned.
 AVERage The measurement results averaged over the given number of measurements are returned.
 MAXHold The maximum result determined over the given number of measurements is returned.
 MINHold The minimum result determined over the given number of measurements is returned.

Note:

The specified result type must be one of those configured with the command [SENSe:]ADEMod:FM:AFSPectrum[:TYPE]. Otherwise a query error will be generated.

Returned values:**ASCII format (FORMat ASCII):**

In this case, the command returns a comma-separated list (comma separated values = CSV) of the measured values in floating-point format. The output unit is dBm with logarithmic display and volt with linear display.

Binary format (FORMat REAL,32):

In this case the command returns binary data (definite length block data to IEEE 488.2), each measured value being formatted in 32-bit IEEE 754 floating point format. When seen schematically, the return string is structured as follows:

#41024<value1><value2>...<value n>

with

#4 number of digits (4 in the example) of the following number of data bytes

1024 number of following data bytes (# of DataBytes, 1024 in the example)

<value x> 4 byte floating point value

Examples:

ADEM:SET 8MHz,32000,EXT,POS,-500,30	'Sets demodulator
ADEM:FM AVER,MAXH,MINH	'Selects the FM results to be measured
ADEM:AM WRIT,OFF,OFF	'Selects the AM results to be measured
ADEM:FM:AFSP WRIT,OFF,OFF	'Selects the AF spectrum
	'results of the demodulated AM signal
	'to be measured
ADEM ON	'Switches the demodulator on
INIT;*WAI	'Starts the measurement and waits for
	'termination
FORM ASC	'Selects output format
ADEM:FM:RES? AVER	'Reads FM average result data
ADEM:FM:RES? MAXH	'Reads FM Maxhold result data
ADEM:FM:RES? MINH	'Reads FM Minhold result data
ADEM:AM:RES? WRIT	'Reads current AM result data
ADEM:FM:AFSP:RES? WRIT	'Reads current AF spectrum result data
	'of demodulated FM signal

Characteristics: *RST value: -
 SCPI: device-specific

Mode: FM

This command is only available with option R&S FS-K7 (FM demodulator).

[SENSe:]ADEMod:FM:OFFSet? <result type>

This command calculates the FM offset of the currently available measurement data set. If averaging has been activated before acquiring the data set (using [SENSe:]ADEMod:FM[:TYPE]), the averaged FM offset over several measurements can be obtained as well by setting <result type> = AVERAge.

The offset thus determined differs from that calculated in the command CALC:MARK:FUNC:ADEM:FERR?, since using that command, for determination of the frequency deviation, the modulation is removed by means of lowpass filtering, producing results that are different from those obtained by averaging.

Parameters:

<result type>: IMMEDIATE	The current measurement results will be used for calculating the FM offset
AVERAge	The measurement results that were averaged over the given # of measurements will be used for calculating the FM offset

Note:

If no average measurement was active during the last measurement sequence only the command [SENSe:]ADEMod:FM:OFFSet? IMMEDIATE will return a valid result (data to calculate the offset are taken from the last measured data set).

[SENSe:]ADEMod:FM:OFFSet? AVERAge will cause a query error in this case.

Examples:

ADEM:SET 8MHz,32000,EXT,POS,-500,30	'Sets up demodulator parameters to execute 30 measurements
ADEM:FM AVER,OFF,OFF	'Sets up FM results to do averaging
ADEM:AM OFF,OFF,OFF	'Sets up AM results to off
ADEM ON	'Switches on demodulator
INIT;*WAI	'Starts measurement and waits for sync
ADEM:FM:OFFS? IMM	'Reads FM offset of last measurement of the sequence of 30
ADEM:FM:OFFS? AVER	'Reads FM offset averaged over 30 measurements

Characteristics: *RST values: -
SCPI: device-specific

Mode: FM

This command is only available with option R&S FS-K7 (FM Demodulator).

[SENSe:]ADEMod:PM[:TDOMain][:TYPE] <result type 1>,<result type 2>,<result type 3>

This command selects the result types to be measured in parallel by PM demodulation.

Parameter:

<result type 1/2/3>:

WRITe	The current measured values are recorded.
AVERAge	The measurement results are averaged over the given number of measurements.
MAXHold	The maximum result over the given number of measurements is obtained.
MINHold	The minimum result over the given number of measurements is obtained.
VIEW	The measurement result is frozen on the display, i.e. it is not recalculated in further measurements.
OFF	The result type is not used.

Notes: *Settings different from OFF can only be assigned to one result type at a time.
By setting all result types to OFF the AM demodulator is deactivated.*

Examples:

ADEM:PM	AVER,MAXH,MINH	'Determines average, maximum and minimum value at a time
ADEM:PM	WRIT,OFF,OFF	'Determines the current measured values only
ADEM:PM	OFF,OFF,OFF	'Switches off the PM demodulator

Characteristics: *RST values: OFF,OFF,OFF
SCPI: device-specific

Mode: A

This command is only available with option R&S FS-K7 (FM demodulator).

[SENSe:]ADEMod:PM[:TDOMain]:RESult?<result type>

This command reads the result data obtained by PM demodulation depending on the type indicated as a parameter. The data format of the output data is defined by the FORMat command.

Note:

The query of traces in the VIEW state is not possible.

Parameter:

<result type>:

WRITe	The current measurement results are obtained.
AVERAge	The measurement results averaged over the given number of measurements are obtained.
MAXHold	The maximum result is determined over the given number of measurements.
MINHold	The minimum result is determined over the given number of measurements.

Note:

The result type indicated must be one of those configured by [SENSe:]ADEMod:AM[:TDOMain][:TYPE]. Otherwise a query error will be generated.

Return values:**ASCII format (FORMat ASCII):**

In this case the command will yield a list of comma-separated values (CSV) of the measured values in floating point format. The output unit is %.

Binary format (FORMat REAL,32):

In this case the command will yield binary data (definite length block data according to IEEE 488.2), each measured value being formatted in the 32-bit IEEE 754 floating point format. The schematics of the result string will be as follows:

```
#41024<value1><value2>...<value n>
```

with

```
#4          number of digits (4 in the example) in the following number of data bytes
1024       number of following data bytes (# of DataBytes, = 1024 in the example)
<value x>  4-byte floating point value
```

Examples:

```
ADEM:SET 8MHz,32000,EXT,POS,-500,30 'Set up demodulator parameters
ADEM:PM AVER,MAXH,MINH 'Select PM results to measure
ADEM:AM WRIT,OFF,OFF 'Select AM results to measure
ADEM ON 'Switch on demodulator
INIT;*WAI 'Start measurement and wait 'for end
FORM ASC 'select output format
ADEM:PM:RES? AVER 'Read PM average results
ADEM:PM:RES? MAXH 'Read PM Maxhold results
ADEM:PM:RES? MINH 'Read PM Minhold results
ADEM:AM:RES? WRIT 'Read current AM results
```

Characteristics: *RST value: -
SCPI: device-specific

Mode: FM

The command is only available with option R&S FS-K7 (FM demodulator).

[SENSe:]ADEMod:PM:AFSPpectrum[:TYPE] <result type 1>,<result type 2>,<result type 3>

This command selects the simultaneously measured result types of the AF spectrum of the pM demodulated signal.

Parameter: <result type 1/2/3>: WRITe The current measurement results are recorded.
 AVERage The measurement results averaged over the given number of measurements are obtained.
 MAXHold The maximum result is determined over the given number of measurements.
 MINHold The minimum result is determined over the given number of measurements.
 VIEW The measurement result in the display is frozen, i.e. it is not recalculated in further measurements.
 OFF The result type is not used.

Note:

Settings other than OFF can be assigned only to one result type at a time.

If all result types are set to OFF, the AF spectrum of the PM demodulated signal is not calculated.

The result type "AF spectrum of the PM demodulated signal" cannot be activated at the same time as "AF spectrum of AM demodulated signal".

ADEM:PM:AFSP	AVER,MAXH,MINH	Determines average, maximum and minimum value simultaneously
ADEM:PM:AFSP	WRIT,OFF,OFF	'Determines only current measurement results
ADEM:PM:AFSP	OFF,OFF,OFF	'Switches calculation of AF spectrum off

Characteristics: *RST values: OFF,OFF,OFF
 SCPI: device-specific

Mode: A

This command is only available with option R&S FS-K7 (FM demodulator).

[SENSe:]ADEMod:PM:AFSPectrum:RESult? <result type>

This command reads out measurement results of the AF spectrum of the PM demodulated signal with the specified result type. The data format of the output data is determined with the FORMat command.

Note: *Traces in the VIEW state cannot be queried.*

Parameter: <result type>: WRITe The current measurement results are returned.
 AVERAge The measurement results averaged over the given number of measurements are returned.
 MAXHold The maximum result determined over the given number of measurements is returned.
 MINHold The minimum result determined over the given number of measurements is returned.

Note:

The specified result type must be one of those configured with the command [SENSe:]ADEMod:PM:AFSPectrum[:TYPE]. Otherwise a query error will be generated.

Returned values:**ASCII format (FORMat ASCII):**

In this case, the command returns a comma-separated list (comma separated values = CSV) of the measured values in floating-point format. The output unit is dBm with logarithmic display and volt with linear display.

Binary format (FORMat REAL,32):

In this case the command returns binary data (definite length block data to IEEE 488.2), each measured value being formatted in 32-bit IEEE 754 floating point format. When seen schematically, the return string is structured as follows:

#41024<value1><value2>...<value n>

with

#4 number of digits (4 in the example) of the following number of data

bytes

1024 number of following data bytes (# of DataBytes, 1024 in the example)

<value x> 4 byte floating point value

Examples:

ADEM:SET 8MHz,32000,EXT,POS,-500,30	'Sets demodulator
ADEM:PM AVER,MAXH,MINH	'Selects the PM results to be measured
ADEM:AM WRIT,OFF,OFF	'Selects the AM results to be measured
ADEM:PM:AFSP WRIT,OFF,OFF	'Selects the AF spectrum
	'results of the demodulated AM signal
	'to be measured
ADEM ON	'Switches the demodulator on
INIT;*WAI	'Starts the measurement and waits for
	'termination
FORM ASC	'Selects output format
ADEM:PM:RES? AVER	'Reads PM average result data
ADEM:PM:RES? MAXH	'Reads PM Maxhold result data
ADEM:PM:RES? MINH	'Reads PM Minhold result data
ADEM:AM:RES? WRIT	'Reads current AM result data
ADEM:PM:AFSP:RES? WRIT	'Reads current AF spectrum result data
	'of demodulated PM signal

Characteristics: *RST value: -
 SCPI: device-specific

Mode: FM

This command is only available with option R&S FS-K7 (FM demodulator).

[SENSe:]ADEMod:SPECTrum:BWIDth|BWIDth[:RESolution] 1 Hz to 10 MHz

This command sets the resolution bandwidth for spectrum representation that was determined from the analog demodulation data.

The recording time required is calculated from the and the sampling rate indirectly set via ADEM:SPEC:SPAN:MAX or ADEM:BAND. If the available recording time is not sufficient for the given bandwidth, the recording time is set to its maximum and the resolution bandwidth is enlarged to the resulting bandwidth.

Example: "ADEM ON" 'Switches on the FM demodulator
 "CALC:FEED XTIM:SPEC' 'Switches on the result display RF spectrum
 or "CALC:FEED XTIM:FM:AFSP' 'Switches on the result display AF spectrum
 of FM
 or "CALC:FEED XTIM:RFP:AFSP' 'Switches on the result display AF spectrum
 of RF power signal
 "ADEM:BAND:RES 61.2kHz" 'Sets the resolution bandwidth to 61.2 kHz.

Characteristics: *RST value: 61.2 kHz
 SCPI: device-specific

Mode: FM

This command is only available with option R&S FS-K7 (FM Demodulator).

[SENSe:]ADEMod:SPECTrum:SPAN[:MAXimum] <numeric_value>

This command sets the maximum frequency range for displaying the RF spectrum that was determined from the FM demodulation data. The maximum span corresponds to the measurement bandwidth of analog demodulation (SENS:ADEM:BAND).

Only discrete values are possible for the span since the available sampling rates are discrete.

Span	Sampling rate
10 MHz	32 MHz
8 MHz	16 MHz
5 MHz	8 MHz
3 MHz	4 MHz
1.6 MHz	2 MHz
800 kHz	1 MHz
400 kHz	500 kHz
200 kHz	250 kHz
100 kHz	125 kHz
50 kHz	62.5 kHz
25 kHz	31.25 kHz
12.5 kHz	15.625 kHz

Example: "ADEM ON" 'Switches on the FM demodulator
 "CALC:FEED XTIM:SPEC' 'Switches on result display RF spectrum
 "ADEM:SPEC:SPAN:MAX 5 MHz" 'Sets the max. span to 5 MHz
 "ADEM:SPEC:SPAN:ZOOM 1 MHz" 'Sets the displayed span to 1 MHz

Characteristics: *RST value: 5 MHz
 SCPI: device-specific

Mode: FM

This command is only available with option R&S FS-K7 (FM Demodulator).

[SENSe:]ADEMod:SPECTrum:SPAN:ZOOM <numeric_value>

This command sets the frequency range for result display of RF spectrum determined from FM demodulation data. The frequency range for result display is limited to the maximum span (SENS:ADEM:SPEC:SPAN:MAX) or to the measurement bandwidth of analog demodulation (SENS:ADEM:BAND).

Example:

```
"ADEM ON"                'Switches on the FM demodulator
"CALC:FEED XTIM:SPEC'    'Switches on result display RF spectrum"
"ADEM:SPEC:SPAN:MAX 5 MHz" 'Sets the maximum span to 5 MHz
"ADEM:SPEC:SPAN:ZOOM 1 MHz" 'Sets displayed span to 1 MHz
```

Characteristics: *RST value: 5 MHz
SCPI: device-specific

Mode: FM

This command is only available with option R&S FS-K7 (FM demodulator).

[SENSe:]ADEMod:SPECTrum[:TYPE] <result type 1>,<result type 2>,<result type 3>

This command selects the result types to be created in parallel by the RF SPECTrum measurement with active analog demodulation.

Parameters: <result type 1/2/3>.: WRITE The current measurement results will be obtained
AVERage The measurement results will be averaged over the given # of measurements
MAXHold The maximum result values will be obtained over the given # of measurements
MINHold The minimum result values will be obtained over the given # of measurements
VIEW The measurement results are frozen and displayed, i.e. they are not calculated for subsequent measurements.
OFF The result type will not be used.

Note: Each value besides OFF can only be assigned to one result type at a time.

Examples: ADEM:SPEC AVER,MAXH,MINH 'Creates average, max hold and min hold values at a time
ADEM:SPEC WRIT,OFF,OFF 'Only creates the current measurement values
ADEM:SPEC OFF,OFF,OFF 'Switches FM demodulation off

Characteristics: *RST values: OFF,OFF,OFF
SCPI: device-specific

Mode: FM

This command is only available with option R&S FS-K7 (FM Demodulator).

[SENSe:]ADEMod:SPECTrum:RESult? <result type>

This command reads the result data obtained by RF SPECTrum measurement depending on the type indicated as a parameter. The data format of the output data block is defined by the FORMat command.

Note: *It is not possible to read out trace data when result type VIEW is selected.*

Parameters:

<result type>:	WRITe	The current measurement results will be obtained
	AVERage	The measurement results will be averaged over the given # of measurements
	MAXHold	The maximum result values will be obtained over the given # of measurements
	MINHold	The minimum result values will be obtained over the given # of measurements

Notes: *The result type indicated must be one of those configured by [SENSe:]ADEMod:SPEC[:TYPE]. Otherwise a query error will be generated.*

Return Values:**ASCII Format (FORMat ASCII):**

In this case the command will yield a list of comma separated values (CSV) of the measured values in floating point format. The output unit is dBm.

Binary Format (FORMat REAL,32):

In this case the command will yield binary data (Definite Length Block Data according to IEEE 488.2), each measurement value being formatted in 32 Bit IEEE 754 Floating-Point-Format. The schematics of the result string will be as follows:

#41024<value1><value2>...<value n>

with

#4 number of digits (= 4 in the example) of the following number of data bytes

1024 number of following data bytes (= 1024 in the example)

<value x> 4-Byte-Floating Point Value

Examples:

ADEM:SET 8MHz, 32000, EXT, POS, -500, 30	'Sets up demodulator parameters
ADEM:SPEC AVER, MAXH, MINH	'Sets up RF spectrum results to measure
ADEM:SPEC WRIT, OFF, OFF	'Sets up AM results to measure
ADEM ON	'Switches on demodulator
INIT; *WAI	'Starts measurement and waits for sync
FORM ASC	'Selects output format
ADEM:SPEC:RES? AVER	'Reads RF spectrum average results
ADEM:SPEC:RES? MAXH	'Reads RF spectrum max hold results
ADEM:SPEC:RES? MINH	'Reads RF spectrum min hold results
ADEM:SPEC:RES? WRIT	'Reads spectrum current results

Characteristics: *RST values: -
SCPI: device-specific

Mode: FM

This command is only available with option R&S FS-K7 (FM Demodulator).

[SENSe<1|2>:]ADEMod:ZOOM[:STATe>] ON | OFF

The command enables or disables the zoom function for the FM-demodulator measurement data. Depending on the selected measurement time and the demodulation bandwidth, the number of recorded test points may be greater than that shown on the display.

With the zoom function enabled, exactly 501 test points of the result memory are displayed from the time defined with [SENSe:]ADEMod:ZOOM:START.

With the zoom function disabled, data reduction is used to adapt the test points to the number of points available on the display.

Example: "ADEM:ZOOM ON" 'Switches on the zoom function

Characteristics: *RST value: OFF
SCPI: device-specific

Mode: FM

This command is only available with option R&S FS-K7 (FM demodulator) installed

[SENSe<1|2>:]ADEMod:ZOOM:START 0s to measurement time

The command selects the start time for the display of individual measured values of the FM demodulator. The maximum possible value depends on the measurement time, which is set in the instrument and can be queried with command [SENSe]:ADEMod:MTIME?.

If the zoom function is activated, 501 test points are displayed from the specified start time.

Example: "ADEM:ZOOM ON" 'Switches on the zoom function
"ADEM:ZOOM:STAR 500us" 'Sets the starting point of the display to 500 µs.

Characteristics: *RST value: 0 s
SCPI: device-specific

Mode: FM

This command is only available with option R&S FS-K7 (FM demodulator) installed

SENSe:AVERage Subsystem

The SENSe:AVERage subsystem calculates the average of the acquired data. A new test result is obtained from several successive measurements.

There are two types of average calculation: logarithmic and linear. In case of logarithmic average calculation (denoted with VIDEo), the average value of the measured logarithmic power is calculated and in case of linear average calculation, the linear power is averaged before the logarithm is applied.

The measurement windows are selected by SENSe1 (screen A) and SENSe2 (screen B).

COMMAND	PARAMETERS	UNIT	COMMENT
[SENSe<1 2>] :AVERage :COUNT [:STATe<1 to 3>] :TYPE	<numeric_value> <Boolean> VIDeO LINear	-- -- --	

[SENSe<1|2>]:AVERage:COUNT 0 to 32767

In receiver mode, this command defines the number of scan started with single scan. In analyzer mode, it defines the number of measurements which contribute to the average value.

It should be noted that continuous averaging will be performed after the indicated number has been reached in continuous sweep mode.

In single sweep or scan mode, the scan/sweep is stopped as soon as the indicated number of measurements (scans/sweeps) is reached. Synchronization to the end of the indicated number of measurements is only possible in single scan/sweep mode.

The command [SENSe<1 | 2> :]AVERage: COUNT is the same as command [SENSe<1 | 2> :]SWEep: COUNT. In both cases, the number of measurements is defined whether the average calculation is active or not.

The number of measurements is valid for all traces in the indicated measurement window.

Example:

"SWE:CONT OFF"	Switching to single-sweep mode.
"AVER:COUN 16"	'Sets the number of measurements to 16.
"AVER:STAT ON"	'Switches on the calculation of average.
"INIT;*WAI"	'Starts the measurement and waits for the end of the 16 sweeps.

Characteristics: *RST value: 0
SCPI: conforming

Mode: all

[SENSe<1|2>]:AVERage[:STATe<1 to 3>] ON | OFF

This command switches on or off the average calculation for the selected trace (STATe<1 to 3>) in the selected measurement window.

Example:

"AVER OFF"	'Switches off the average calculation for trace 1 in screen A.
"SENS2:AVER:STAT3 ON"	'Switches on the average calculation for trace 3 in screen B.

Characteristics: *RST value: OFF
SCPI: conforming

Mode: all

[SENSe<1|2>:]AVERage:TYPE VIDEo | LINear

This command selects the type of average function. If VIDEo is selected, the logarithmic power is averaged and, if LINear is selected, the power values are averaged before they are converted to logarithmic values.

The type of average calculation is equally set for all traces in one measurement window.

Example: "AVER:TYPE LIN" 'Switches screen A to linear average calculation.

Characteristics: *RST value: VIDEo
SCPI: device-specific

Mode: A

SENSe:BANDwidth Subsystem

This subsystem controls the setting of the instrument's filter bandwidths. Both groups of commands (BANDwidth and BWIDth) perform the same functions. The measurement windows are selected by SENSe1 (screen A) and SENSe2 (screen B).

COMMAND	PARAMETERS	UNIT	COMMENT
[SENSe<1 2>] :BANDwidth			
[:RESolution]	<numeric_value>	HZ	
:AUTO	<Boolean>	--	
:RATio	<numeric_value>	--	
:TYPE	NORMal FFT CFILter RRC NOISe PULSe	--	
:VIDeo	<numeric_value>	HZ	
:AUTO	<Boolean>	--	
:RATio	<numeric_value>	--	
:TYPE	LINear LOGarithmic	--	Option FM demodulator
:DEMod	<numeric_value>	HZ	
:BWIDth			
[:RESolution]	<numeric_value>	HZ	
:AUTO	<Boolean>	--	
:RATio	<numeric_value>	--	
:TYPE	NORMal FFT CFILter RRC NOISe PULSe	--	
:VIDeo	<numeric_value>	HZ	
:AUTO	<Boolean>	--	
:RATio	<numeric_value>	--	
:TYPE	LINear LOGarithmic	--	Option FM demodulator
:DEMod	<numeric_value>	HZ	

[SENSe<1|2>:]BANDwidth|BWIDth[:RESolution] <numeric_value>

This command defines the receiver IF bandwidth or, in *SPECTRUM* mode, the analyzer's resolution bandwidth.

Analog resolution filters from 10 Hz to 10 MHz in 1, 3, 10 steps are available. These filters are implemented as 4-circuit LC filters in the range from 300 kHz to 10 MHz and as digital filters with analog characteristic in the range of 10 Hz to 100 kHz.

In addition, the EMI bandwidths 200 Hz, 9 kHz and 120 kHz are available (6 dB bandwidths each). These bandwidths can only be obtained by entering numeric values and not with the commands *INCrement* and *DECrement*.

The EMI bandwidths are only available when parameter *PULSe* is selected by command *BAND:TYPE*.

FFT filters from 1 Hz to 30 kHz (3 dB bandwidth each) are also available in the frequency domain (span > 0) for fast measurements on periodic signals. The instrument automatically switches to analog filters above 30 kHz.

The FFT bandwidths are not available if the preselector is switched on.

A number of especially steep-edged channel filters can be selected provided that parameters *CFILter* or *RRC* are selected using the *BAND:TYPE* command. The possible combinations of filter type and filter bandwidth are listed in the table "List of available channel filters" of chapter 4, section "Setting Bandwidths and Sweep Time— Key *BW*".

If the resolution bandwidth is modified in *SPECTRUM* mode, the coupling to the span is automatically switched off.

If the resolution bandwidth is modified in FM DEMOD mode, the coupling to the demodulation bandwidth is automatically switched off.

Example: "BAND 120 kHz" 'Sets the IF bandwidth to 120 kHz

Characteristics: *RST value: - (AUTO is set to ON)
SCPI: conforming

Mode: all

[SENSe<1|2>:]BANDwidth|BWIDth[:RESolution]:AUTO ON | OFF

In RECEIVER mode with activated quasi peak detector, this command either automatically couples the IF bandwidth of the receiver to the frequency range or cancels the coupling .

In SPECTRUM mode, this command either automatically couples the resolution bandwidth of the instrument to the span or cancels the coupling. In FM DEMOD mode, this command either automatically couples the IF bandwidth of the instrument to the demodulation bandwidth or cancels the coupling ($BW_{RBW} = 10 * BW_{Demod}$).

In FM DEMOD mode, the coupling refers to the demodulation bandwidth ($BW_{RBW} = 10 * BW_{Demod}$).

The automatic coupling adapts the resolution bandwidth to the currently set frequency span according to the relationship between frequency span and resolution bandwidth. The 6 dB bandwidths 200 Hz, 9 kHz and 120 kHz and the channel filters available from Version 1.10 are not set by the automatic coupling.

The ratio resolution bandwidth/span can be modified with the command

[SENSe<1|2>:]BANDwidth[:RESolution]:RATio.

Example: "BAND:AUTO OFF" 'Switches off the coupling of the IF bandwidth to the frequency range (receiver mode).
'Switches off the coupling of the resolution bandwidth to the span (analyzer mode).
'Switches off the coupling of the IF bandwidth to the demodulation bandwidth (FM demod mode).

Characteristics: *RST value: ON
SCPI: conforming

Mode: R, A-F, FM

[SENSe<1|2>:]BANDwidth|BWIDth[:RESolution]:RATio 0.0001 to 1

This command defines the ratio resolution bandwidth (Hz) / span (Hz). The ratio to be entered is reciprocal to the ratio span/RBW used in manual control.

Example: "BAND:RAT 0.1"

Characteristics: *RST value: 0.02 with BAND:TYPE NORMAl or RBW > 30 kHz
0.01 with BAND:TYPE FFT for RBW ≤ 30 kHz
SCPI: conforming

Mode: A

[SENSe<1|2>:]BANDwidth|BWIDth[:RESolution]:TYPE NORMal | FFT | CFILter | RRC | NOISe | PULSe

This command switches the filter type for the resolution bandwidth between "normal" analog or FIR filters in 1, 3, 10 steps and the FFT filtering for bandwidths <100 kHz.

The advantage of FFT filtering is the higher measurement speed compared to digital filters with analog filter characteristic. However, FFT filters are only suitable for periodic signals, and they are only available for span > 0 Hz.

Steep-edged channel filters and filters with RRC (Root Raised Cosine) characteristic are available. The possible combinations of filter type and filter bandwidth are listed in the table "List of available channel filters" in chapter 4, section "Setting Bandwidths and Sweep Time– Key BW".

The filter type PULSe selects the 6 dB bandwidths for EMI measurements rather than the 3 dB bandwidths for spectrum analysis, which is selected with type NOISe.

Notes: - When changing the filter type, the next larger filter bandwidth is selected if the same filter bandwidth is not available for the new filter type.

Example: "BAND:TYPE NORM"
Characteristics: *RST value: NORMal
 SCPI: device-specific
Mode: all

[SENSe<1|2>:]BANDwidth|BWIDth:VIDeo 1Hz to 10MHz

This command defines the instrument's video bandwidth. Bandwidths from 10 Hz to 10 MHz in 1, 3, 10 steps are available. The command is not available if FFT filtering is switched on and the set bandwidth is ≤ 30 kHz or if the quasi-peak detector is switched on.

Example: "BAND:VID 10kHz"
Characteristics: *RST value: - (AUTO is set to ON)
 SCPI: conforming
Mode: A

[SENSe<1|2>:]BANDwidth|BWIDth:VIDeo:AUTO ON | OFF

This command either automatically couples the instrument's video bandwidth to the resolution bandwidth or cancels the coupling.

The ratio video bandwidth/resolution bandwidth can be modified with the command [SENSe<1|2>:]BANDwidth:VIDeo:RATio.

Note: In receiver mode, the video bandwidth is set to ten times the resolution bandwidth.

Example: "BAND:VID:AUTO OFF"
Characteristics: *RST value: ON
 SCPI: conforming
Mode: A

[SENSe<1|2>:]BANDwidth|BWIDth:VIDeo:RATio 0.01 to 1000

This command defines the ratio video bandwidth (Hz) / resolution bandwidth (Hz). The ratio to be entered is reciprocal to the ratio RBW/VBW used in manual control.

Example: "BAND:VID:RAT 3" 'Sets the coupling of video bandwidth to video bandwidth = 3*resolution bandwidth
Characteristics: *RST value: 3
 SCPI: conforming
Mode: A

[SENSe<1|2>:]BANDwidth|BWIDth:VIDeo:TYPE LINear | LOGarithmic

This command selects the position of the video filter in the signal path, provided that the resolution bandwidth is ≤ 100 kHz:

- If LINear is selected, the video filter is connected ahead of the logarithmic amplifier (default)
- If LOGarithmic is selected, the video filter follows the logarithmic amplifier

The essential difference between the two modes is the transient response at falling signal edges: If LINear is selected, the measurement with logarithmic level scaling yields a much "flatter" falling edge than LOGarithmic.

This behaviour is due to the conversion of linear power into logarithmic level. If the linear power is halved, the level decreases by only 3 dB.

Example: "BAND:VID:TYPE LIN" 'Video filter ahead of the logarithmic amplifier

Characteristics: *RST value: LIN
SCPI: device-specific

Mode: A

[SENSe<1|2>:]BANDwidth|BWIDth:DEMod <numeric-value>

This command defines the demodulation bandwidth of the instrument for analog demodulation. The required sampling rate is automatically set depending on the selected demodulation bandwidth. The available demodulation bandwidths are determined by the existing sampling rates.

rounded demodulation bandwidth	Sampling rate
10 MHz	32 MHz
8 MHz	16 MHz
5 MHz	8 MHz
3 MHz	4 MHz
1.6 MHz	2 MHz
800 kHz	1 MHz
400 kHz	500 kHz
200 kHz	250 kHz
100 kHz	125 kHz
50 kHz	62.5 kHz
25 kHz	31.25 kHz
12.5 kHz	15.625 kHz

Example: "ADEM:BAND:DEMod 1MHz" 'Sets demodulation bandwidth to 1 MHz.

Characteristics: *RST value: 5 MHz
SCPI: device specific

Mode: FM

This command is only available with option R&S FS-K7 (FM Demodulator).

SENSe:CORRection Subsystem

The SENSe:CORRection subsystem controls the correction of measured results by means of frequency-dependent correction factors (e. g. for antenna or cable attenuation).

This subsystem also controls calibration and normalization during operation with the tracking generator options (B9/B10). The measurement windows are selected by SENSe1 (screen A) and SENSe2 (screen B).

COMMAND	PARAMETERS	UNIT	COMMENT
[SENSe<1 2>] :CORRection			Ttracking generator option
:MEthod	TRANsmission REFLexion		
:COLLect			
[:ACQuire]	THRough OPEN		no query e
[:STATe]	<Boolean>		
:RECall			no query
:TRANsducer			
:SElect	<name>		
:UNIT	<string>		
:SCALing	LINear LOGarithmic		
:COMMeNT	<string>		
:DATA	<freq> , <level> ..	HZ , --	
[:STATe]	<Boolean>		
:DELeTe	--	--	no query
:VIEW	<Boolean>		
:TSET			
:SElect	<name>		
:UNIT	<string>		
:BREak	<Boolean>		
:COMMeNT	<string>		
:RANGe<1...10>	<freq> , <freq> , @<name> ..	HZ, HZ, --	
[:STATe]	<Boolean>		
:DELeTe	--	--	keine Abfrage
:YIG			
:TEMPerature			
:AUTO	<Boolean>		

[SENSe<1|2>]:CORRection[:STATe] ON | OFF

This command activates/deactivates the normalization of the measurement results in the selected window provided that the tracking generator is active. The command is available only after acquisition of a reference trace for the selected type of measurement (transmission/reflection, see command [SENSe<1|2>]:CORRection:COLLect[:ACQuire]).

Example: "CORR ON " 'Activates normalization in screen A.

Characteristics: *RST value: OFF
SCPI: conforming

Mode: A

This command is only valid in conjunction with the tracking / ext. generator control (B9/B10).

[SENSe<1|2>]:CORRection:MEthod TRANsmission | REFLexion

This command selects the type of measurement with active tracking generator (transmission/reflection).

Example: "CORR:MEth TRAN " 'Sets the type of measurement in screen A to "transmission".

Characteristics: *RST value: TRANsmission
SCPI: device specific

Mode: A

This command is only valid in conjunction with the tracking / ext. generator control option (B9/B10).

[SENSe<1|2>:]CORRection:COLLect[:ACQuire] THROugh | OPEN

When the tracking generator is active, this command determines the type of result acquisition for the normalization reference measurement and starts the measurement selected:

THROugh "TRANsmission" mode: calibration with direct connection between tracking generator and device input.
 "REFLection" mode: calibration with short circuit at the input
 OPEN only valid in "REFLection" mode: calibration with open input

To obtain a valid reference measurement, a complete sweep with synchronization to the end of the sweep must have been carried out. This is only possible in the single sweep mode.

Example: "INIT:CONT OFF" 'Selects single sweep operation
 "CORR:COLL THR;*WAI" 'Starts the measurement of reference data using 'direct connection between generator and device 'input and waits for the sweep end.

Characteristics: *RST value: --
 SCPI: conforming

Mode: A

This command is an "event" and therefore has no *RST value and no query. It is only valid in conjunction with the tracking /external generator option (B9/B10).

[SENSe<1|2>:]CORRection:RECall

This command restores the instrument setting that was valid for the measurement of the reference data, provided that the tracking generator is active.

Example: " CORR:REC "

Characteristics: *RST value: -
 SCPI: conforming

Mode: A

This command is an event and therefore has no *RST value and no query.

This command is only valid in conjunction with the tracking / ext. generator control option (B9/B10).

[SENSe<1|2>:]CORRection:TRANsducer:SElect <name>

This command selects the transducer factor designated by <name>. If <name> does not exist yet, a new transducer factor is created.

This command must be sent prior to the subsequent commands for modifying/activating transducer factors.

Parameter: <name>::= Name of the transducer factor in string data form with a maximum of 8 characters.

Example: ":CORR:TRAN:SEL 'FACTOR1"

Characteristics: *RST value: -
 SCPI: device-specific

Modes: A

[SENSe<1|2>:]CORRection:TRANsdUcer:UNIT <string>

This command defines the unit of the transducer factor selected.

Parameter: <string> ::= 'DB' | 'DBM' | 'DBMV' | 'DBUV' | 'DBUV/M' | 'DBUA' | 'DBUA/M' | 'DBPW' | 'DBPT'

Example: ":CORR:TRAN:UNIT 'DBUV'"

Characteristics: *RST value: 'DB'
SCPI: device-specific

Modes: A

Prior to this command, the command SENS:CORR:TRAN:SEL must be sent.

[SENSe<1|2>:]CORRection:TRANsdUcer:SCALing LINear | LOGarithmic

This command defines whether the frequency scaling of the transducer factor is linear or logarithmic.

Example: ":CORR:TRAN:SCAL LOG"

Characteristics: *RST value: LINear
SCPI: device-specific

Modes: A

Prior to this command, the command SENS:CORR:TRAN:SEL must be sent.

[SENSe<1|2>:]CORRection:TRANsdUcer:COMMeNT <string>

This command defines the comment for the selected transducer factor.

Example: ":CORR:TRAN:COMM 'FACTOR FOR ANTENNA'"

Characteristics: *RST value: " (empty comment)
SCPI: device specific

Modes: A

Prior to this command, the command SENS:CORR:TRAN:SEL must be sent.

[SENSe<1|2>:]CORRection:TRANsdUcer:DATA <freq>,<level>..

This command defines the reference values of the transducer factor selected. These values are entered as a sequence of frequency/level pairs. The frequencies must be sent in ascending order.

Note: *The level values are sent as dimensionless numbers; the unit is specified by means of the command SENS:CORR:TRAN:UNIT.*

Example: ":CORR:TRAN:TRANsdUcer:DATA 1MHZ,-30,2MHZ,-40"

Characteristics: *RST value: -
SCPI: device-specific

Modes: A

Prior to this command, the command SENS:CORR:TRAN:SEL must be sent.

[SENSe<1|2>:]CORRection:TRANsdUcer[:STATe] ON | OFF

This command switches the selected transducer factor on or off.

Example: ":CORR:TRAN ON"

Characteristics: *RST value: OFF
SCPI: device-specific

Modes: A

Prior to this command, the command SENS:CORR:TRAN:SEL must be sent.

[SENSe<1|2>:]CORRection:TRANsducer:DELEte

This command deletes the selected transducer factor.

Example: ":CORR:TRAN:DEL"

Characteristics: *RST value: -
SCPI: device-specific

Modes: A

This command is an event and therefore has no *RST value. Prior to this command, the command SENS:CORR:TRAN:SEL must be sent.

:[SENSe<1|2>:]CORRection:TRANsducer:VIEW ON | OFF

This command switches on the display of the active transducer factor or set.

Example: "CORR:TRAN:VIEW ON"

Characteristics: *RST value: OFF
SCPI: device-specific

Mode: A

Prior to this command, the command SENS:CORR:TRAN:SEL must be sent.

:[SENSe<1|2>:]CORRection:TRANsducer:RLEVel[:STATe] ON | OFF

This command switches on the automatic adjustment of the reference level to the selected transducer factor.

Example: "CORR:TRAN:RLEV ON"

Characteristics: *RST value: OFF
SCPI: device-specific

Mode: A

Prior to this command, the command SENS:CORR:TRAN:SEL must be sent.

[SENSe<1|2>:]CORRection:TSET:SElect <name>

This command selected the transducer set designated by <name>. If <name> does not exist yet, a new set is created.

Parameter: <name>::= name of the transducer set in string data form with a maximum of 8 characters.

Example: ":CORR:TSET:SEL 'SET1'"

Characteristics: *RST value: -
SCPI: device-specific

Modes: R, A

This command must be sent prior to the subsequent commands for changing/activating the transducer sets.

[SENSe<1|2>:]CORRection:TSET:UNIT <string>

This command defines the unit of the selected transducer sets. When assigning transducer factors to the set, only factors which are compatible to the selected unit, i. e. factors with the same unit or the unit dB, are allowed.

Parameter: <string>::= DB' | 'DBM' | 'DBUV' | 'DBUV/M' | 'DBUA' | 'DBUA/M' | 'DBPW' | 'DBPT'

Example: " :CORR:TSET:UNIT 'DBUV' "

Characteristics: *RST value: 'DB'
SCPI: device-specific

Modes: R, A

Prior to this command, the command SENS:CORR:TSET:SEL must be sent.

[SENSe<1|2>:]CORRection:TSET:BREak ON | OFF

This command defines if the sweep is to be stopped on changeover from range to another.

Example: " :CORR:TSET:BRE ON "

Characteristics: *RST value: OFF
SCPI: device-specific

Modes: R, A

Prior to the above command, the command SENS:CORR:TSET:SEL must be sent.

[SENSe<1|2>:]CORRection:TSET:COMMeNT <string>

This command defines the comment for the selected transducer set.

Example: " :CORR:TSET:COMM 'SET FOR ANTENNA' "

Characteristics: *RST value " (empty comment)
SCPI: device specific

Modes: A

Prior to this command, the command SENS:CORR:TSET:SEL must be sent.

[SENSe<1|2>:]CORRection:TSET:RANGe<1 to 10> <freq>,<freq>,<name>..

This command defines a partial range of the selected transducer set. The partial range is determined by its start and stop frequencies plus a list of names of the assigned transducer factors. The ranges 1 to 10 must be sent in ascending order.

Parameter: <freq>,<freq>::= start frequency, stop frequency of the range
<name>...::= list of names for the assigned transducer factors.
The individual names must be characterized by single quotation marks (') and separated by commas.

Example: " :CORR:TRAN:TSET:RANG 1MHZ,2MHZ, 'FACTOR1', 'FACTOR2' "

Characteristics: *RST value: -
SCPI: device-specific

Modes: R, A

Prior to this command, the command SENS:CORR:TSET:SEL must be sent.

[SENSe<1|2>:]CORRection:TSET[:STATe] ON | OFF

This command switches the selected transducer set on or off.

Example: " :CORR:TSET ON"

Characteristics: *RST value: OFF
SCPI: device-specific

Modes: R, A

Prior to this command, the command SENS:CORR:TSET:SEL must be sent.

[SENSe<1|2>:]CORRection:TSET:DELeTe

This command deletes the selected transducer set.

Example: " :CORR:TSET:DEL"

Characteristics: *RST value: -
SCPI: device-specific

Modes: R, A

This command is an event and therefore has no *RST value.

Prior to this command, the command SENS:CORR:TSET:SEL must be sent.

: [SENSe<1|2>:]CORRection:YIG:TEMPerature:AUTO ON | OFF

This command switches on or off the automatic correction of the YIG filter frequency drift.

When correction is switched on, it is checked once per minute whether the temperature on the YIG filter has changed by more than 5K relative to the last instance of correction. If this is the case, the frequency of the YIG filter is – at the end of the next measurement – adjusted as required for the new temperature. For time-critical applications, the correction function can be switched off after an operating period of ≥ 30 minutes.

Example: "CORR:YIG:TEMP OFF" 'Switches off automatic correction of the YIG filter frequency drift.

Characteristics: *RST value: ON
SCPI: device-specific

Mode: all

The ON parameter is available only if the MW CONV UNIT module has one of the following modification states:

Order No.	Rev	SubRev
1130.2396	≥ 02	≥ 01
1130.2544	≥ 02	≥ 01

SENSe:DEMod Subsystem

The SENSe:DEMod subsystem controls the analog demodulation of the video signal.

COMMAND	PARAMETER	UNIT	COMMENT
[SENSe<1 2>] :DEMod	OFF AM FM		

: [SENSe<1|2>]:DEMod OFF | AM | FM

This command selects the type of analog demodulation.

Example: " :DEM FM"

Characteristics: *RST value: OFF
SCPI: device-specific

Modes: R

SENSe:DETECTOR Subsystem

The SENSe:DETECTOR subsystem controls the acquisition of measurement data via the selection of the detector for the corresponding trace. The measurement windows are selected by SENSe1 (screen A) and SENSe2 (screen B).

COMMAND	PARAMETERS	UNIT	COMMENT
[SENSe<1 2>] :DETECTOR<1..3> [:FUNCTION]	APEak NEGative POSitive SAMPlE RMS AVERAge QPEak CAVerage CRMS	--	
:AUTO RECEIVER [:FUNCTION]	<Boolean> POSitive NEGative RMS AVERAge QPEak CAVerage CRMS, POSitive NEGative RMS AVERAge QPEak CAVerage CRMS ..		
:FMEASUREMENT	POSitive NEGative RMS AVERAge QPEak CAVerage CRMS		

[SENSe<1|2>:]DETECTOR<1 to 3>[:FUNCTION] APEak | NEGative | POSitive | SAMPlE | RMS | AVERAge | QPEak |CAVerage|CRMS

This command switches on the detector for the data acquisition in the selected trace and the indicated measurement window.

- The APEak detector (AutoPeak) displays the positive and also the negative peak value of the noise floor. If a signal is detected, only the positive peak value is displayed.
- The POSitive or NEGative detector only displays the positive or the negative peak value.
- With the Sample detector the value measured at the sampling time is displayed, whereas the RMS value of the power measured at each test point is displayed with the RMS detector.
- The AVERAge detector displays the power average value at each test point.
- The "CAVerage" detector represents the average value weighted with a time constant. This detector is not available in the analyzer mode.
- The QPEak detector performs a signal evaluation for EMC measurements.

If QPEak is selected, the video filter is automatically switched off. The couplings between span and RBW as well as between RBW and sweep time are also switched off and restored on selecting another detector. A long sweep time should be selected so that the quasi-peak detector can fully settle at each test point.

The trace is indicated as numeric suffix in DETECTOR.

Example: "DET POS" 'Sets the detector in screen A to "positive peak".

Characteristics: *RST value: APEak
SCPI: conforming

Mode: A

[SENSe<1|2>:]DETECTOR<1 to 3>[:FUNCTION]:AUTO ON | OFF

This command either couples the detector in the selected measurement window to the current trace setting or turns coupling off. The trace is selected by the numeric suffix at DETECTOR.

Example: "DET:AUTO OFF"

Characteristics: *RST value: ON
SCPI: conforming

Mode: A

[SENSe<1|2>:]DETECTOR:RECEIVER[:FUNCTION] POSitive | NEGative | RMS | AVERAge | QPEak
|CAVERage|CRMS

This command activates the detectors for single point measurements in EMI receiver operating mode.

A trace cannot be selected. Three detectors can be activated at the same time.

Example: "DET:REC POS,AVER,QPE" activates the detectors Peak, Average and Quasipeak.

Characteristics: *RST value: POS
SCPI: conforming

Mode: R

:[SENSe<1|2>:]DETECTOR<1 to 3>:FMEASUREMENT NEGative | POSitive | RMS | AVERAge | QPEak
|CAVERage|CRMS

This command selects the detector for the final measurement (the detector used subsequent to the prescan)

Example: ":DET:FME POS"

Characteristics: *RST value: Trace 1 QPEak
Trace 2 AVERAge
Trace 3 RMS
SCPI: device-specific

Mode: R

SENSe:FMEasurement Subsystem

This subsystem control the parameters of final measurement in the receiver.

COMMAND	PARAMETER	UNIT	COMMENT
[SENSe<1 2>] :FMEasurement :THReshold [:STATe] :NBBB [:STATe] :LEVel :AUTO :LISN [:TYPE] :PHASe :PEARth :TIME	 <Boolean> <Boolean> <numeric_value> <Boolean> TWOPhase FOURphase OFF L1 L2 L3 N, L1 L2 L3 N .. GROunded FLOating, GROunded FLOating .. <numeric_value>	 -- -- DB -- -- -- -- S	

:[SENSe<1|2>]:FMEasurement:THReshold[:STATe] ON | OFF

Example: "FME:THR ON "
Characteristics: *RST value: OFF
 SCPI: device-specific
Mode: R

:[SENSe<1|2>]:FMEasurement:NBBB[:STATe] ON | OFF <numeric_value>:

Example: "FME:NBBB ON"
Characteristics: *RST value: OFF
 SCPI: device-specific
Mode: R

:[SENSe<1|2>]:FMEasurement:NBBB:LEVel <numeric_value>:

This command enters the decision threshold to be used by the analyzer to discriminate between broadband and narrowband interference.

Example: "FME:NBBB:LEV 6 DB "
Characteristics: *RST value: 6 dB
 SCPI: device-specific
Mode: R

:[SENSe<1|2>]:FMEasurement:AUTO ON | OFF

This command switches between automatic and interactive final measurement.

Example: "FME:AUTO ON"
Characteristics: *RST value: ON
 SCPI: device-specific
Mode: R

:[SENSe<1|2>:]FMEasurement:LISN[:TYPE] TWOPhase | FOURphase | OFF

This command selects the V-network to be controlled via the user port:

TWOPhase = Two-line V-network ESH3-Z5

FOURphase = Four-line V-network ESH2-Z5 oder ENV4200

OFF = remote control is deactivated

Example: " :FME:LISN:TWOP "

Characteristics: *RST value: OFF
SCPI: device specific

Mode: R

:[SENSe<1|2>:]FMEasurement:LISN:PHASe L1 | L2 | L3 | N

This command selects the phase of the V-network on which the RFI voltage is to be measured.

Example: " :FME:LISN:PHAS L1 "

Characteristics: *RST value: L1
SCPI: device specific

Mode: R

:[SENSe<1|2>:]FMEasurement:LISN:PEARth GROunded | FLOating

This command selects the setting of the protection earth of the V-network.

Example: " :FME:LISN:PEAR GRO "

Characteristics: *RST value: GROunded
SCPI: device specific

Mode: R

:[SENSe<1|2>:]FMEasurement:TIME <numeric_value>

This command defines the measurement time in which the values indicated in the peak list (final measurement values) are re-checked.

Example: " :FME:TIME 0.01 "

Characteristics: *RST value: 1 s
SCPI: device specific

Mode: R

SENSe:FREQUENCY Subsystem

The SENSe:FREQUENCY subsystem defines the frequency axis of the active display. The frequency axis can either be defined via the start/stop frequency or via the center frequency and span. The measurement windows are selected by SENSe1 (screen A) and SENSe2 (screen B).

COMMAND	PARAMETERS	UNIT	COMMENT
[SENSe<1 2>] :FREQUency			
:CENTer	<numeric_value>	HZ	
:STEP	<numeric_value>	HZ	
:LINK	SPAN RBW OFF	--	
:FACTor	<numeric_value>	PCT	
:SPAN	<numeric_value>	HZ	
:FULL	--	--	
:START	<numeric_value>	HZ	
:STOP	<numeric_value>	HZ	
:MODE	CW FIXed SWEep		
:OFFSet	<numeric_value>	HZ	
:CW:	<numeric_value>	HZ	receiver mode
:STEP	<numeric_value>	HZ	receiver mode
:FIXed	<numeric_value>	HZ	receiver mode
:STEP	<numeric_value>	HZ	receiver mode

[SENSe<1|2>:]FREQUency:CENTer 0 to f_{max}

This command defines the receiver frequency or the center frequency in analyzer mode.

Example: "FREQ:CENT 100MHz"

Characteristics: *RST value: $f_{max}/2$ with f_{max} = maximum frequency
SCPI: conforming

Mode: all

[SENSe<1|2>:]FREQUency:CENTer:STEP 0 to f_{max}

This command defines the step width of the center frequency.

Example: "FREQ:CENT:STEP 120MHz"

Characteristics: *RST value: - (AUTO 0.1 \times SPAN is switched on)
SCPI: conforming

Mode: all

[SENSe<1|2>:]FREQUency:CENTer:STEP:LINK SPAN | RBW | OFF

This command couples the step width of the center frequency to span (span > 0) or to the resolution bandwidth (span = 0) or cancels the couplings.

Parameters:

SPAN = Coupling to frequency display range (for span > 0)
RBW = Coupling to resolution bandwidth (for span = 0)
OFF = manual input, no coupling.

Example: "FREQ:CENT:STEP:LINK SPAN"

Characteristics: *RST value: SPAN
SCPI: device-specific

Mode: A

[SENSe<1|2>:]FREQUENCY:CENTer:STEP:LINK:FACTor 1 to 100 PCT

This command couples the step width of the center frequency with a factor to the span (span >0) or to the resolution bandwidth (span = 0).

Example: "FREQ:CENT:STEP:LINK:FACT 20PCT"

Characteristics: *RST value: - (AUTO 0.1 × SPAN is switched on)
SCPI: device-specific

Mode: A

[SENSe<1|2>:]FREQUENCY:SPAN 0 to f_{\max}

This command defines the frequency span in the analyzer mode.

Example: "FREQ:SPAN 10MHz"

Characteristics: *RST value: f_{\max} with f_{\max} = maximum frequency
SCPI: conforming

Mode: A

[SENSe<1|2>:]FREQUENCY:SPAN:FULL

This command sets the frequency span in the analyzer mode to its maximum.

Example: "FREQ:SPAN:FULL"

Characteristics: *RST value: -
SCPI: conforming

Mode: A

[SENSe<1|2>:]FREQUENCY:START 0 to f_{\max}

This command defines the start frequency of the overall scan in receiver mode. It defines the start frequency of the sweep in analyzer mode..

Example: "FREQ:STAR 20MHz"

Characteristics: *RST value: 0
SCPI: conforming

Mode: R, A-F

[SENSe<1|2>:]FREQUENCY:STOP 0 to f_{\max}

This command defines the stop frequency of the overall scan in receiver mode. It defines the stop frequency of the sweep in analyzer mode..

Example: "FREQ:STOP 2000MHz"

Characteristics: *RST value: f_{\max}
SCPI: conforming

Mode: R, A-F

[SENSe<1|2>:]FREQuency:MODE CW | FIXed | SWEep

This command switches between single frequency measurement (CW) and scan (SCAN), if in EMI receiver operating mode. In SPECTRUM mode it switches between frequency domain (SWEep) and time domain (CW | FIXed).

In SCAN mode the frequency setup is performed using the commands FREQuency:START, FREQuency:STOP in the SENSe:SCAN subsystem.

Example: "FREQ:MODE SWE"
Characteristics: *RST value: CW
SCPI: conforming
Mode: R, A

[SENSe<1|2>:]FREQuency:OFFSet <numeric_value>

This command defines the frequency offset of the instrument.

Example: "FREQ:OFFS 1GHZ"
Characteristics: *RST value: 0 Hz
SCPI: conforming
Mode: A, FM

SENSe:LIST Subsystem

The commands of this subsystem are used for measuring the power at a list of frequency points with different device settings. The measurement is always performed in the time domain (span = 0 Hz).

A new trigger event is required for each test point (exception: Trigger FREE RUN).

The results are output as a list in the order of the entered frequency points. The number of results per test point depends on the number of concurrently active measurements (peak/RMS/average).

Selection of concurrently active measurements and setting of parameters that are constant for the whole measurement is via a configuration command (SENSe:LIST:POWer:SET). This also includes the setting for trigger and gate parameters.

The following setting parameters can be selected independently for each frequency point:

- Analyzer frequency
- Reference level
- RF attenuation
- Resolution filter
- Resolution bandwidth
- Video bandwidth
- Measurement time
- Detector

The number of frequencies is limited to 100 entries.

The commands of this subsystem can be used in two different ways:

1. Instrument setup, measurement and querying of the results in a single command:
With this method, there is the least delay between the measurement and the result output. However, it requires the control computer to wait for the response from the instrument.
2. Instrument setup and querying of the result list at the end of the measurement:
With this method, the control computer may be used for other activities while the measurement is being performed. However, more time is needed for synchronization via service request.

Note: *Settings that are not directly included in commands of this subsystem can be configured by sending the corresponding commands prior to the SENSe:LIST-commands.*

Please note that changes to the trigger level have to be executed in time domain (span = 0 Hz) in order to take effect for the SENSe:LIST-commands.

COMMAND	PARAMETER	UNIT	COMMENT
[SENSe<1 2>] :LIST :POWer :RESult? [:SEQuence]	<numeric_value>, <numeric_value>, <numeric_value>, <numeric_value> OFF, NORMal CFILter RRC, <numeric_value>, <numeric_value>, <numeric_value>, <numeric_value>	HZ, DBM, DB, DB, --, HZ, HZ, S, PCT DBM	Query only
:SET	<Boolean>, <Boolean>, <Boolean>, IMMEDIATE EXTernal VIDEo IFPower, POSitive NEGative, <numeric_value>, <numeric_value>	--, --, --, --, --, S, S	
:STATe	OFF		

[SENSe<1|2>]:LIST:POWer[:SEQuence] <analyzer freq>,<ref level>,<rf att>,OFF,
<filter type>,<rbw>,<vbw>,<meas time>,<trigger level>,...

This command configures the list of settings (max. 100 entries) for the multiple power measurement and starts a measurement sequence. When synchronizing the command with *OPC, a service request is generated as soon as all frequency points are processed and the defined number of individual measurements is reached.

To reduce the setting time, all indicated parameters are set up simultaneously at each test point.

The query form of the command processes the list and immediately returns the list of results. The number of results per test point depends on the setting of the "SENSe:LIST:POWer:SET" command.

Parameter: Note: The following parameters are the settings for an individual frequency point. They are repeated for every other frequency point.

For reasons of compatibility with the FSP instrument family, input OFF is required after parameter <rf att>.

- <analyzer freq>: Receive frequency for the signal to be measured
(= center frequency in manual operation)
Range of values: 0 Hz to max. frequency, depending on the instrument model.
- <ref level>: Reference level
Range of values: +30 dBm to -75 dBm in 5 dB steps
- <rf att>: RF input attenuation
Range of values: 0 dB to 75 dB in 5 dB steps

Step	Freq. [MHz]	Ref Level	RF Att	OFF	Filter type	RBW	VBW	Meas Time	TRG Level
1	935.2	-20 dBm	10 dB	OFF	Normal	1 MHz	3 MHz	434 us	0
2	935.4	-20 dBm	10 dB	10dB	Channel	30 kHz	100 kHz	434 us	0
3	935.6	-20 dBm	10 dB	20dB	Channel	30 kHz	100 kHz	434 us	0

```
"SENSe:LIST:POWer? 935.2MHz,-20dBm,10dB,OFF,NORM,1MHz,3MHz,434us,0,
935.4MHz,-20dBm,10dB,OFF,CFIL,30kHz,100kHz,434us,0,
935.6MHz,-20dBm,10dB,OFF,CFIL,30kHz,100kHz,434us,0"
```

performs the same measurement and returns the result list immediately after the last frequency point.

Notes: - The measurement is performed in the time domain and therefore the span is set to 0 Hz. If the time domain is abandoned, the function is automatically switched off.

- The measurement is not compatible with other measurements, especially as far as marker, adjacent channel power measurement or statistics are concerned. The corresponding commands thus automatically deactivate the function.

- The function is only available in REMOTE operation. It is deactivated when switching the instrument back to LOCAL.

Characteristics: *RST value: --
SCPI: device-specific

Mode: A-F, A-T

[SENSe<1|2>:]LIST:POWer:SET <PEAK meas>,<RMS meas>,<AVG meas>,
<trigger mode>,<trigger slope>,<trigger offset>,<gate length>

This command defines the constant settings for the list during multiple power measurement.

Parameters <PEAK meas>, <RMS meas> and <AVG meas> define, which measurements are to be performed at the same time at the frequency point. Correspondingly, one, two or three results per frequency point are returned for the `SENSe:LIST:POW?` command. If all three parameters are set to OFF, the command generates an execution error.

Parameter:

<PEAK meas>:	ON	activates the measurement of the peak power (peak detector).
	OFF	deactivates the measurement of the peak power.
<RMS meas>:	ON	activates the measurement of the RMS power (RMS detector).
	OFF	deactivates the measurement of the RMS power.
<AVG meas>:	ON	activates the measurement of the average power (average detector).
	OFF	deactivates the measurement of the average power.
<trigger mode>:	Selection of the trigger source used for the list measurement.	
	Possible values: IMMEDIATE VIDEO EXTERNAL IFPOWER	
<trigger slope>:	Used trigger slope.	
	Possible values: POSITIVE NEGATIVE	
<trigger offset>:	Offset between the detection of the trigger signal and the start of the measurement at the next frequency point.	
	Range of values: 0 s, 125 ns to 100s	
<gate length>:	Gate length with Gated Sweep.	
	Range of values: 0 s, 125 ns to 100s	

Note:

- The value 0 s deactivates the use of GATED TRIGGER; other values activate the GATED TRIGGER function.
- Values <> 0 s are only possible if <trigger mode> is different from IMMEDIATE. Otherwise, an execution error is triggered.

Returned values:

The query command returns a list of comma-separated values (CSV) of the settings, i.e.

ON, ON, ON, IMM, POS, 0, 0

if the configuration has been set with the command

"SENSe:LIST:POWer:SET ON, ON, ON, IMM, POS, 0, 0"

Examples: "SENSe:LIST:POWer:SET ON, OFF, OFF, EXT, POS, 10US, 434US"
"SENSe:LIST:POWer:SET ON, ON, ON, VID, NEG, 10US, 0"

Characteristics: *RST values: ON, OFF, OFF, IMM, POS, 0S, 0S
SCPI: device-specific

Mode: A-F, A-T

[SENSe<1|2>:]LIST:POWer:RESult?

This command queries the result of a previous list measurement as configured and initiated with `SENSe:LIST:POWer[:SEQuence]`. The measured results are output in a list of floating point values separated by commas. The unit of the results depends on the setting made with the `CALC:UNIT` command.

This command may be used to obtain measurement results in an asynchronous way, using the service request mechanism for synchronization with the end of the measurement.

If no measurement results are available, the command will return a query error.

Example:

'Configuration of the status reporting system for the generation of an SRQ on operation complete

*ESE 1

*SRE 32

'Configuring and starting the measurement

```
"SENSe:LIST:POWer      935.2MHz,-20dBm,10dB,OFF,NORM,1MHz,3MHz,434us,0,
                        935.4MHz,-20dBm,10dB,OFF,NORM,30kHz,100kHz,434us,0,
                        935.6MHz,-20dBm,10dB,OFF,NORM,30kHz,100kHz,434us,0;
                        *OPC"
```

'Further actions of the control computer during measurement

...

'Response to service request

On SRQ:

SENSe:LIST:POWer:RESult?

Characteristics: *RST value: --
SCPI: device-specific

Mode: A-F, A-T

[SENSe<1|2>:]LIST:POWer:STATe OFF

This command deactivates the list measurement.

Example: "SENSe:LIST:POWer:STATe OFF"

Characteristics: *RST value: --
SCPI: device-specific

Mode: A-F, A-T

SENSe:MPOWER Subsystem

The commands of this subsystem are used to determine the mean burst power or peak burst power for a given number of signal bursts, and for outputting the results in a list. Since all the settings required for a measurement are combined in a single command, the measurement speed is considerably higher than when using individual commands.

For measuring the signal bursts, the GATED SWEEP function is used in the time domain. The gate is controlled either by an external trigger signal or by the video signal. An individual trigger event is required for each burst to be measured. If an external trigger signal is used, the threshold is fixed to TTL level, while with a video signal the threshold can be set as desired.

The following graphics shows the relation between trigger time, trigger offset (for delayed gate opening) and measurement time.

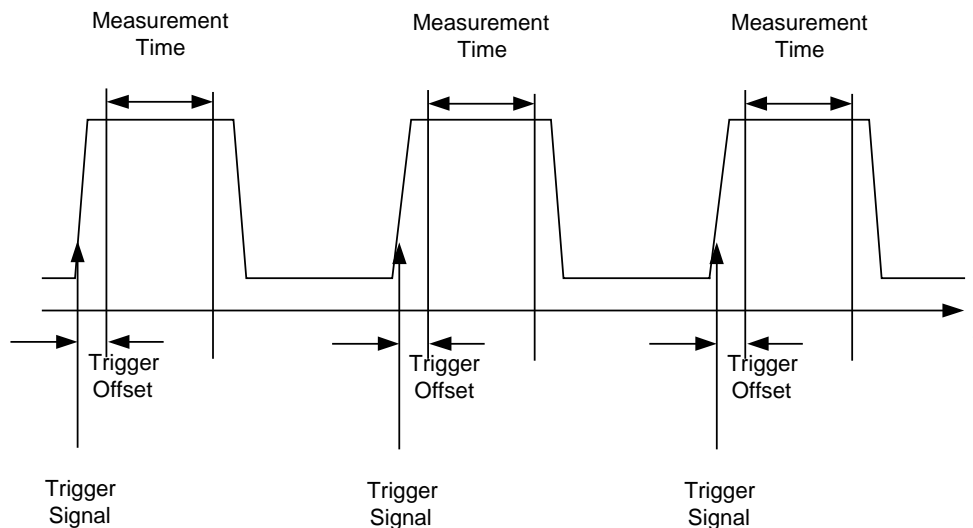

Depending on the settings made, the measurements are performed with the RMS detector for RMS power or the PEAK detector for peak power. For all these measurements, TRACE 1 of the selected system is used.

The setting parameters for this measurement are:

- analyzer frequency
- resolution bandwidth
- measurement time used for a single burst
- trigger source
- trigger level
- trigger offset
- type of power measurement (PEAK, MEAN)
- number of bursts to be measured

The commands of this subsystem can be used in two different ways:

1. Setting up the instrument and at the same time querying the result list: This method ensures the smallest delay between measurement and the output of the measured values, but requires the control computer to wait actively for the response of the instrument.
2. Setting up the instrument and querying the result list after synchronization to the end of measurement: With this method the control computer can be used for other activities while the instrument is performing the measurement at the cost of additional time needed for synchronization via service request.

COMMAND	PARAMETER	UNIT	COMMENT
[SENSe<1 2>] :MPOWer [:SEQuence] :RESult [:LIST]? :MIN?	<numeric_value>, <numeric_value>, <numeric_value>, EXTernal VIDeo <numeric_value>, <numeric_value>, MEAN PEAK, <numeric_value>	HZ, HZ, S, --, PCT, S, --, --	 Query only Query only

[SENSe<1|2>:]MPOWer[:SEQuence] <analyzer freq>,<rbw>,<meas time>,<trigger source>,<trigger level>,<trigger offset>,<type of meas>,<# of meas>

This command configures the instrument setup for multiple burst power measurement and starts a measurement sequence. When synchronizing the command with *OPC, a service request is generated as soon as the defined number of individual measurements (# of meas) is reached.

To reduce the setting time, the setup is performed simultaneously for all selected parameters.

The command in the form of a query makes the instrument settings, performs the defined number of measurements and outputs the measurement results list.

Parameters:

- <analyzer freq>: Receive frequency for the burst signals to be measured (= center frequency in manual operation)
Range: 0 Hz to max. frequency, depending on instrument model
- <rbw>: resolution bandwidth for the measurement
Range: 10 Hz to 10 MHz in steps of 1, 3, 10
- <meas time>: Time span during which measurement samples are sampled for RMS / peak measurement The type of measurement is selected by <type of meas>.
Range: 1us to 30s
- <trigger source>: trigger signal source. Possible settings:
EXTernal The trigger signal is fed from the "Ext. Trigger/Gate" input on the rear of the unit.
VIDeo The internal video signal is used as trigger signal.
- <trigger level>: Signal level at which the trigger becomes active. For <trigger source> = VIDeo this is the level of the video signal as a percentage of the diagram height. If <trigger source> = EXTernal is selected, the value entered here is ignored, as in this case the trigger input uses TTL levels.
Range: 0 – 100PCT (<trigger source> = VIDeo)
- <trigger offset>: Offset between the detection of the trigger signal and the start of the measurement.
Range: 125 ns to 100s
- <type of meas>: Determines whether mean power (RMS) or peak power (PEAK) is to be measured. The detector is selected accordingly.
Possible values:MEAN, PEAK
- <# of meas>: Number of individual bursts to be measured.
Range: 1 to 501

Return values:

The query command returns a list separated by commas (comma separated values = CSV), which contains the power measurement results in floating-point format. The unit used for the return values is always dBm.

The command "SENSe:MPOWer? 935.2MHz,1MHz,434us,VIDEO,50PCT,5us,MEAN,20" may, for instance, cause the following list to be returned:

18.3,18.6,18.1,18.0,17.9,18.3,18.6,18.1,18.0,17.9,18.3,18.6,18.1,18.0,17.9,18.3,18.6,18.1,18.0,17.9

Examples:

"SENSe:MPOWer 935.2MHz,1MHz,434us,VIDEO,50PCT,5us,MEAN,20" performs a measurement sequence with the following settings:

Frequency = 935.2 MHz,
 Resolution bandwidth = 1 MHz
 Measurement time = 434 μ s
 Trigger source = VIDEO
 Trigger threshold = 50%
 Trigger offset = 5 μ s
 Type of measurement = MEAN power
 No. of measurements = 20

"SENSe:MPOWer? 935.2MHz,1MHz,434us,VIDEO,50PCT,5us,MEAN,20" performs the same measurement and in addition returns the results list immediately after completion of the last measurement.

Notes:

The measurement function always uses trace 1 in the selected screen, and activates the selected screen.

Repeated use of the command without changes to its parameters (i.e. using the same settings again) will speed up the measurement since the previous hardware settings will be cached and therefore additional hardware settling times will be avoided. This also holds true if only part of the parameters (e.g. only the trigger delay) are changed, as in this case the rest of the parameters will be cached.

This measurement is not compatible with other measurements, especially as far as marker functions, adjacent-channel measurement or statistics are concerned. The corresponding functions are therefore automatically switched off. In return incompatible commands will automatically deactivate the multi burst power function.

The function is only available in the REMOTE operation. It is deactivated on switching back to LOCAL.

Characteristics: *RST value: --
 SCPI: instrument-specific

Mode: A-F, A-T

SENSe:MPOWer:RESult[:LIST]?

This command queries the results of a multiple burst power measurement as configured and initiated with `SENSe:MPOWer[:SEquence]`. The results are output in a comma-separated list of floating point values. The unit used for the return values is always dBm.

This command may be used to obtain measurement results in an asynchronous way using the service request mechanism for synchronization with the end of the measurement.

If no measurement results are available, the command will return a query error.

Example:

```
*ESE 1           'Configuration of status reporting systems for the
*SRE 32         'generation of an SRQ on operation complete

SENSe:MPOWer
935.2MHz,1MHz,434us,VIDEO,50PCT,5us,MEAN,20;*OPC
           'Configuring and starting the measurement
...       'Further actions of the control computer during
           'measurement
On SRQ:      'Response to service request
SENSe:MPOWer:RESult?
```

Characteristics: *RST value: --
SCPI: instrument-specific

Mode: A-F, A-T

SENSe:MPOWer:RESult:MIN?

This command queries the minimum power value in a multiple burst power measurement as configured and initiated with `SENSe:MPOWer[:SEquence]`. The unit used for the return values is always dBm.

If no measurement result is available, the command will return a query error.

Example:

```
*ESE 1           'Configuration of status reporting systems for the
*SRE 32         'generation of an SRQ on operation complete

SENSe:MPOWer
935.2MHz,1MHz,434us,VIDEO,50PCT,5us,MEAN,20;*OPC
           'Configuring and starting the measurement
...       'Further actions of the control computer during
           'measurement
On SRQ:      'Response to service request
SENSe:MPOWer:RESult:MIN?
```

Characteristics: *RST value: --
SCPI: instrument-specific

Mode: A-F, A-T

SENSe:POWer Subsystem

This subsystem controls the setting of the instrument's channel and adjacent channel power measurements. The measurement windows are selected by SENSE1 (screen A) and SENSE2 (screen B).

COMMAND	PARAMETERS	UNIT	COMMENT
[SENSe<1 2>] :POWer :ACHannel :SPACing :CHANnel [:ACHannel] :ALTErnate<1 2> :TXCHannel :COUNt :ACPairs :BANDwidth [:CHANnel] :ACHannel :ALTErnate<1 2> :BWIDth [:CHANnel] :ACHannel :ALTErnate<1 2> :MODE :REFerence :AUTO :TXCHannel :AUTO :MANUAL :PRESet :RLEVel :BANDwidth :BWIDth :HSPeed :NCORrection :TRACe	<numeric_value> <numeric_value> <numeric_value> <numeric_value> 0 1 2 3 <numeric_value> <numeric_value> <numeric_value> <numeric_value> <numeric_value> <numeric_value> <numeric_value> ABSolute RELative ONCE MINimum MAXimum LHIGhest 1 2 3 4 ACPower CPOWer MCACpower OBANdwidth OBWidth CN CN0 <numeric_value> <numeric_value> <Boolean> <Boolean> <numeric_value>	HZ HZ HZ HZ HZ HZ HZ HZ HZ HZ HZ HZ PCT PCT --	no query no query no query

[SENSe<1|2>]:POWer:ACHannel:SPACing:CHANnel 100 Hz to 2000 MHz

This command defines the channel spacing for the carrier signals.

The command is available only for measurements in the frequency domain (span > 0).

Example: " POW:ACH:SPAC:CHAN 25kHz "

Characteristics: *RST value: 20 kHz
SCPI: device-specific

Mode: A-F

[SENSe<1|2>:]POWer:ACHannel:SPACing[:ACHannel] 100 Hz to 2000 MHz

This command defines the channel spacing of the adjacent channel to the TX channel. At the same time, the spacing of alternate adjacent channels 1 and 2 is set to the double or triple of the entered value. The command is only available in the frequency domain (span > 0).

Example: "POW:ACH:SPAC:ACH 33kHz" 'Sets the spacing between the carrier signal and
'and
'- the adjacent channel to 33 kHz
'- the alternate adjacent channel 1 to 66 kHz
'- the alternate adjacent channel 2 to 99 kHz

Characteristics: *RST value: 14 kHz
SCPI: device-specific

Mode: A-F

[SENSe<1|2>:]POWer:ACHannel:SPACing:ALTErnate<1|2> 100 Hz to 2000 MHz

This command defines the spacing between the first (ALTErnate1) or the second alternate adjacent channel (ALTErnate2) and the TX channel. If the spacing to the alternate adjacent channel ALTErnate1 is modified, the spacing to alternate adjacent channel 2 is set to 1.5 times the entered value. This command is only available in the frequency domain (span > 0).

Example: "POW:ACH:SPAC:ALT1 100kHz" 'Sets the spacing between TX channel and
'alternate adjacent channel 1 to 100 kHz and
'between TX channel and alternate adjacent
'channel 2 to 150 kHz.

Characteristics: *RST value: 40 kHz (ALT1)
60 kHz (ALT2)
SCPI: device-specific

Mode: A-F

[SENSe<1|2>:]POWer:ACHannel:TXCHannel:COUNT 1 | 2 | 3 | 4

This command selects the number of carrier signals.

The command is available only for multicarrier channel and adjacent-channel power measurements (CALC:MARK:FUNC:POW:SEL MCAC) in the frequency domain (span > 0).

Example: "POW:ACH:TXCH:COUN 3"

Characteristics: *RST value: 4
SCPI: device-specific

Mode: A-F

[SENSe<1|2>:]POWer:ACHannel:ACPairs 0 | 1 | 2 | 3

This command sets the number of adjacent channels (upper and lower channel in pairs). The figure 0 stands for pure channel power measurement.

The command is only available in the frequency domain (span > 0).

Example: "POW:ACH:ACP 3" 'Sets the number of adjacent channels to 3, i.e. the
'adjacent channel and alternate adjacent channels 1 and
'2 are switched on.

Characteristics: *RST value: 1
SCPI: device-specific

Mode: A-F

[SENSe<1|2>:]POWer:ACHannel:BANDwidth|BWIDth[:CHANnel] 100 Hz to 1000 MHz

This command sets the channel bandwidth of the radio communication system. The bandwidths of adjacent channels are not influenced by this modification (in contrast to the FSE family).

With `SENSe:POWer:HSP` ON the steep-edged channel filters from the table "List of available channel filters" in Section "Setting Bandwidths and Sweep Time – Key *BW*" are available.

Example: `"POW:ACH:BWID 30kHz"` 'Sets the bandwidth of the TX channel to '30 kHz.

Characteristics: *RST value: 14 kHz
SCPI: device-specific

Mode: A-F

[SENSe<1|2>:]POWer:ACHannel:BANDwidth|BWIDth:ACHannel 100 Hz to 1000 MHz

This command defines the channel bandwidth of the adjacent channel of the radio transmission system. If the bandwidth of the adjacent channel is changed, the bandwidths of all alternate adjacent channels are automatically set to the same value.

With `SENSe:POWer:HSP` ON the steep-edged channel filters from the table "List of available channel filters" in Section "Setting Bandwidths and Sweep Time – Key *BW*" are available.

Example: `"POW:ACH:BWID:ACH 30kHz"` 'Sets the bandwidth of all adjacent channels to '30 kHz.

Characteristics: *RST value: 14 kHz
SCPI: device-specific

Mode: A-F

[SENSe<1|2>:]POWer:ACHannel:BANDwidth|BWIDth:ALTErnate<1|2> 100 Hz to 1000 MHz

This command defines the channel bandwidth of the first/second alternate adjacent channel of the radio transmission system. If the channel bandwidth of alternate adjacent channel 1 is changed, the bandwidth of alternate adjacent channel 2 is automatically set to the same value.

With `SENSe:POWer:HSP` ON the steep-edged channel filters from the table "List of available channel filters" in Section "Setting Bandwidths and Sweep Time – Key *BW*" are available.

Example: `"POW:ACH:BWID:ALT2 30kHz"`

Characteristics: *RST value: 14 kHz
SCPI: device-specific

Mode: A-F

[SENSe<1|2>:]POWer:ACHannel:MODE ABSolute | RELative

This command toggles between absolute and relative adjacent channel measurement.

For the relative measurement the reference value is set to the currently measured channel power by command `SENSe:POWer:ACHannel:REFErnance:AUTO ONCE`.

The command is only available in the frequency domain (span > 0).

Example: `"POW:ACH:MODE REL"`

Characteristics: *RST value: ABSolute
SCPI: device-specific

Mode: A-F

[SENSe<1|2>:]POWer:ACHannel:REference:AUTO ONCE

This command sets the reference value for the relative measurement to the currently measured channel power.

The command is only available in the frequency domain (span > 0).

Example: "POW:ACH:REF:AUTO ONCE"

Characteristics: *RST value: -
SCPI: device-specific

Mode: A-F

This command is an event and therefore has no *RST value and no query.

[SENSe<1|2>:]POWer:ACHannel:REference:TXChannel:AUTO MINimum | MAXimum | LHIGhest

This command activates the automatic selection of a transmission channel to be used as a reference channel in relative adjacent-channel power measurements.

The transmission channel with the highest power, the transmission channel with the lowest power, or the transmission channel nearest to the adjacent channels can be defined as a reference channel.

The command is available only for multicarrier channel and adjacent-channel power measurements (CALC:MARK:FUNC:POW:SEL MCAC) in the frequency domain (span > 0).

Parameters: MINimum Transmission channel with the lowest power
MAXimum Transmission channel with the highest power
LHIGhestLowermost transmission channel for the lower adjacent channels,
uppermost transmission channel for the upper adjacent channels

Example: "POW:ACH:REF:TXCH:AUTO MAX" 'The transmission channel with the highest power is used as a reference channel.'

Characteristics: *RST value: -
SCPI: device-specific

Mode: A-F

[SENSe<1|2>:]POWer:ACHannel:REference:TXChannel:MANual 1 | 2 | 3 | 4

This command selects a transmission channel to be used as a reference channel in relative adjacent-channel power measurements.

The command is available only for multicarrier channel and adjacent-channel power measurements (CALC:MARK:FUNC:POW:SEL MCAC) in the frequency domain (span > 0).

Example: "POW:ACH:REF:TXCH:MAN 3" 'Transmission channel 3 is used as a reference channel.'

Characteristics: *RST value: 1
SCPI: device-specific

Mode: A-F

[SENSe<1|2>:]POWer:ACHannel:PRESet ACPower | CPOWer | MCACpower | OBANdwidth | OBWidth | CN | CN0

This command adjusts the frequency span, the measurement bandwidths and the detector as required for the number of channels, the channel bandwidths and the channel spacings selected in the active power measurement. If necessary, adjacent-channel power measurement is switched on prior to the adjustment.

To obtain valid results, a complete sweep with synchronization to the end of the sweep must be performed after the adjustment. Synchronization is possible only in the single-sweep mode.

The result is queried with the command CALCulate:MARKer:FUNCTion:POWer:RESult?.

The command is available only for measurements in the frequency domain (span > 0).

Example: "POW:ACH:PRES ACP" 'Sets the frequency span, the measurement bandwidths and the detector as required for the ACP measurement in screen A.
 "INIT:CONT OFF" 'Switches over to single-sweep mode.
 "INIT;*WAI" 'Starts a sweep and waits for the end of the sweep.
 "CALC:MARK:FUNC:POW:RES? ACP" 'Queries the result of the adjacent-channel power measurement.

Characteristics: *RST value: -
 SCPI: device-specific

Mode: A-F

[SENSe<1|2>:]POWer:ACHannel:PRESet:RLEVel

This command adapts the reference level to the measured channel power and – if required - switches on previously the adjacent channel power measurement. This ensures that the signal path of the instrument is not overloaded. Since the measurement bandwidth is significantly smaller than the signal bandwidth in channel power measurements, the signal path can be overloaded although the trace is still significantly below the reference level. If the measured channel power equals the reference level, the signal path is not overloaded.

The command is only available in the frequency domain (span > 0).

Note: *Subsequent commands have to be synchronized with *WAI, *OPC or *OPC? to the end of the autorange process which would otherwise be aborted.*

Example: "POW:ACH:PRES:RLEV;*WAI" 'Adapts the reference level to the measured channel power.

Characteristics: *RST value: -
 SCPI: device-specific

Mode: A-F

[SENSe<1|2>:]POWer:BANDwidth|BWIDth 10 to 99.9PCT

This command defines the percentage of the power with respect to the total power. This value is the basis for the occupied bandwidth measurement (command: POWer:ACHannel:PRESet OBW).

The command is only available in the frequency domain (span > 0).

Example: "POW:BWID 95PCT"

Characteristics: *RST value: 99PCT
 SCPI: device-specific

Mode: A-F

[SENSe<1|2>:]POWer:HSPeEd ON | OFF

This command switches on or off the high-speed channel/adjacent channel power measurement. The measurement itself is performed in the time domain on the center frequencies of the individual channels. The command automatically switches to the time domain and back.

Depending on the selected mobile radio standard, weighting filters with $\sqrt{\cos}$ characteristic or very steep-sided channel filters are used for band limitation.

The command is only available in the frequency domain (span > 0).

Example: "POW:HSP ON"
Characteristics: *RST value: OFF
 SCPI: device-specific
Mode: A-F

[SENSe<1|2>:]POWer:NCORrection ON | OFF

This command switches on or off the correction of the instrument inherent noise for channel power measurement. On activating this function, a reference measurement of the instrument inherent noise is performed. The measured noise power is then subtracted from the power in the examined channel.

The instrument inherent noise is then re-determined after any change of the center frequency, resolution bandwidth, sweep time and level setting by repeating the reference measurement in the new instrument setting.

Example: "POW:NCOR ON"
Characteristics: *RST value: OFF
 SCPI: device-specific
Mode: A

[SENSe<1|2>:]POWer:TRACe 1 to 3

This command assigns the channel/adjacent channel power measurement to the indicated trace in the selected measurement window. The corresponding trace must be active, i.e. its state must be different from blank.

Note: *The measurement of the occupied bandwidth (OBW) is performed on the trace on which marker 1 is positioned. To evaluate another trace, marker 1 must be positioned to another trace with CALCulate:MARKer:TRACe.*

Example: "POW:TRAC 2" 'Assigns the measurement in screen A to trace 2.
 "SENS2:POW:TRAC 3" 'Assigns the measurement in screen B to trace 3.
Characteristics: *RST value: -
 SCPI: device-specific
Mode: A

SENSe:ROSCillator Subsystem

This subsystem controls the reference oscillator. The numeric suffix in SENSe is irrelevant for the commands of this subsystem.

COMMAND	PARAMETERS	UNIT	COMMENT
[SENSe<1 2>] :ROSCillator :SOURce [:INTernal] :TUNe :SAVe	INTernal EXTernal <numeric_value>	--	no query

[SENSe<1|2>:]ROSCillator:SOURce INTernal | EXTernal

This command controls selection of the reference oscillator.

If the external reference oscillator is selected, the reference signal must be connected to the rear panel of the instrument.

Example: "ROSC:SOUR EXT"

Characteristics: *RST value: –
SCPI: conforming

Mode: all

[SENSe<1|2>:]ROSCillator[:INTernal]:TUNe 0 to 4095

This command defines the value for the tuning of the internal reference oscillator.

The reference oscillator should be tuned only if an error has been detected in the frequency accuracy check. After rebooting the instrument, the factory-set reference frequency or the previously saved reference frequency is restored.

Note: This command is only available at service level 1.

Example: "ROSC:TUN 128"

Characteristics: *RST value: –
SCPI: device-specific

Mode: all

[SENSe<1|2>:]ROSCillator[:INTernal]:TUNe:SAVe

This command saves the new value for the tuning of the internal reference oscillator. The factory-set value in the EEPROM is overwritten.

Note: This command is only available at service level 1.

Example: "ROSC:TUN:SAV"

Characteristics: *RST value: –
SCPI: device-specific

Mode: all

SENSe:SCAN Subsystem

This subsystem controls the parameters for the receiver scan data. The numeric suffix in [SENSe<1|2>]SCAN is not significant.

COMMAND	PARAMETER	UNIT	COMMENT
[SENSe<1 2>] :SCAN<1 to 10> :START :STOP :STEP :TIMe :BANDwidth :RESolution :INPut :ATTenuation :AUTO :GAIN :STATe :AUTO :RANGes [:COUNT] :TDOMain	<numeric_value> <numeric_value> <numeric_value> <numeric_value> <numeric_value> <numeric_value> <Boolean> <Boolean> <Boolean> <numeric_value>	HZ HZ HZ S HZ DB -- -- -- s	

[SENSe<1|2>]:SCAN<1 to 10>:START f_{min} to f_{max}

This command defines the start frequency of the selected receiver scan range.

Example: " :SCAN1:STAR 50kHz " 'Sets the start frequency of scan range 1 to 50 kHz

Characteristics: *RST value: 150 kHz (range1)
30 MHz (range2)
SCPI: device-specific

Mode: R

[SENSe<1|2>]:SCAN<1 to 10>:STOP f_{min} to f_{max}

This command defines the stop frequency of the selected receiver scan range.

Example: " :SCAN1:STOP 200kHz " 'Sets the stop frequency of scan range 1 to 200 kHz

Characteristics: *RST value: 30 MHz (range1)
1 GHz (range2)
SCPI: device-specific

Mode: R

[SENSe<1|2>]:SCAN<1 to 10>:STEP f_{min} to f_{max}

This command defines the step size for the frequency of the selected receiver scan range.

Example: " :SCAN1:STEP 100Hz " 'Sets the step size for the frequency of scan range 1 to 100 Hz

Characteristics: *RST value: 4 kHz (range 1)
40 kHz (range 2)
SCPI: device-specific

Mode: R

[SENSe<1|2>:]SCAN<1 to 10>:INPut:GAIN:AUTO ON | OFF

This command includes the preamplifier in the autoranging function of the selected receiver scan range.

Example: " :SCAN1:INP:GAIN:AUTO ON" 'Includes the preamplifier in the autoranging function for scan range 1

Characteristics: *RST value: OFF
SCPI: device-specific

Mode: R

[SENSe<1|2>:]SCAN:RANGes[:COUNT] 1 to 10

This command determines the number of ranges. With setting 0, the scan is performed using the current receiver settings and not the settings defined with commands `SENSe:SCAN: . . .`

Example: "SCAN:RANG:COUN 3" 'Sets the number of ranges to 3

Characteristics: *RST value: 0
SCPI: device-specific

Mode: R

SENSe:SWEep Subsystem

This subsystem controls the sweep parameters. The measurement windows are selected by SENSe1 (screen A) and SENSe2 (screen B).

COMMAND	PARAMETERS	UNIT	COMMENT
[SENSe<1 2>] :SWEep			
:TIME	<numeric_value>	S	
:AUTO	<Boolean>	--	
:COUNT	<numeric_value>	--	
:CURRent?			Query only
:EGATe	<Boolean>	--	
:TYPE	LEVe EDGE	--	
:POLarity	POSitive NEGative	--	
:HOLDoff	<numeric_value>	S	
:LENGth	<numeric_value>	S	
:SOURce	EXTernal RFPower IFPower		
:POINTs	<numeric_value>		
:SPACing	LINear LOGarithmic AUTO		

[SENSe<1|2>]:SWEep:TIME 100 μ s to 100s | 15 sec (receiver) | 2,5ms to 16000s (frequency domain)
| 1 μ s to 16000s (time domain)

This command defines the scan or sweep time. ,

For receiver single scan, the available time value range is 100 μ s to 100 s in 1-2-5 steps. In analyzer mode, the available time values are different in the frequency domain (2.5 ms to 16000s with span > 0) and in the time domain (1 μ s to 16000 s with span = 0).

If SWEep:TIME is directly programmed, automatic coupling to resolution bandwidth and video bandwidth is switched off.

Example: "SWE:TIME 10s"

Characteristics: *RST value - (AUTO is set to ON)
SCPI: conforming

Mode: R, A, FM

[SENSe<1|2>]:SWEep:TIME:AUTO ON | OFF

This command controls the automatic coupling of the sweep time to the frequency span and bandwidth settings.

If SWEep:TIME is directly programmed, automatic coupling is switched off.

Example: "SWE:TIME:AUTO ON" 'Switches on the coupling to frequency span and bandwidths.

Characteristics: *RST value: ON
SCPI: conforming

Mode: A

[SENSe<1|2>:]SWEEp:COUNT 0 to 32767

This command defines the number of scans started with single scan in receiver mode, In analyzer mode, this command defines the number of sweeps started with single sweep, which are used for calculating the average or maximum value. In average mode, the value 0 defines a continuous averaging of measurement data over 10 sweeps.

Example:

"SWE:COUN 64"	'Sets the number of sweeps to 64.
"INIT:CONT OFF"	'Switches to single-sweep mode.
"INIT;*WAI"	'Starts a sweep and waits for its end.

Characteristics: *RST value: 0
SCPI: conforming

Mode: R, A, FM

[SENSe<1|2>:]SWEEp:COUNT:CURRent

This command queries the number of scans started with single scan in receiver mode, In analyzer mode, this command queries the number of sweeps started with single sweep.

Example:

"SWE:COUN 64"	'Sets the number of sweeps to 64.
"INIT:CONT OFF"	'Switches to single-sweep mode.
"INIT"	'Starts a sweep without waits for its end.
"SWE:COUN:CURR?"	'queries the number of sweeps already started.

Characteristics: *RST value: -
SCPI: device-specific

Mode: R, A, FM

[SENSe<1|2>:]SWEEp:EGATe ON | OFF

This command switches on/off the sweep control by an external gate signal. If the external gate is selected the trigger source is automatically switched to EXTERNAL as well.

In case of measurement with external gate, the measured values are recorded as long as the gate is opened. There are two possibilities:

1. The gate is edge-triggered ("SWEEp:EGATe:TYPE EDGE"): After detection of the set gate signal edge, the gate remains open until the gate delay (SWEEp:EGATe:HOLDoff) has expired.
2. The gate is level-triggered ("SWEEp:EGATe:TYPE LEVEL"): After detection of the gate signal, the gate remains open until the gate signal disappears.

A delay between applying the gate signal and the start of recording measured values can be defined with SWEEp:EGATe:HOLDoff.

During a sweep the gate can be opened and closed several times. The synchronization mechanisms with *OPC, *OPC? and *WAI remain completely unaffected.

The sweep end is detected when the required number of measurement points (501 in analyzer mode) has been recorded.

Example:

"SWE:EGAT ON"	'Switches on the external gate mode.
"SWE:EGAT:TYPE EDGE"	'Switches on the edge-triggered mode.
"SWE:EGAT:HOLD 100US"	'Sets the gate delay to 100 µs.
"SWE:EGAT:LEN 500US"	'Sets the gate opening time to 500 µs.
"INIT;*WAI"	'Starts a sweep and waits for its end.

Characteristics: *RST value: OFF
SCPI: device-specific

Mode: A

[SENSe<1|2>:]SWEep:EGATe:TYPE LEVel | EDGE

This command sets the type of triggering (level or edge) by the external gate signal.

The gate opening time cannot be defined with the parameter EGATe:LENGth in case of level triggering. The gate is closed when the gate signal disappears.

Example: "SWE:EGAT:TYPE EDGE"

Characteristics: *RST value: EDGE
SCPI: device-specific

Mode: A

[SENSe<1|2>:]SWEep:EGATe:POLarity POSitive | NEGative

This command determines the polarity of the external gate signal. The setting is valid both for the edge of an edge-triggered signal and the level of a level-triggered signal.

Example: "SWE:EGAT:POL POS"

Characteristics: *RST value: POSitive
SCPI: device-specific

Mode: A

[SENSe<1|2>:]SWEep:EGATe:HOLDoff 125 ns to 100 s

This command defines the delay time between the external gate signal and the continuation of the sweep.

Example: "SWE:EGAT:HOLD 100us"

Characteristics: *RST value: 0s
SCPI: device-specific

Mode: A

[SENSe<1|2>:]SWEep:EGATe:LENGth 0 to 100 s

In case of edge triggering, this command determines the time interval during which the instrument sweeps.

Example: "SWE:EGAT:LENG 10ms"

Characteristics: *RST value: 0s
SCPI: device-specific

Mode: A

[SENSe<1|2>:]SWEep:EGATe:SOURce EXTernal | IFPower | RFPower

This command toggles between external gate signal and IF power signal as a signal source for the gate mode. If an IF power signal is used, the gate is opened as soon as a signal at > -20 dBm is detected within the IF path bandwidth (10 MHz).

Note: Selection RFPower is only available with option R&S FSP-B6 (TV and RF Trigger).

Example: "SWE:EGAT:SOUR IFP" 'Switches the gate source to IF power.

Characteristics: *RST value: IFPower
SCPI: device-specific

Mode: A

[SENSe<1|2>:]SWEEp:POINts 125 to 8001

This command defines the number of measurement points for one sweep run.

Parameter: <numeric_value>:= 125, 251, 501, 1001, 2001, 4001, 8001

Example: "SWE:POIN 251"

Characteristics: *RST value: 501
SCPI: conforming

Modes: A

[SENSe<1|2>:]SWEEp:SPACing LINear | LOGarithmic | AUTO

This command switches between linear, logarithmic and automatically selected linear step size in the receiver. In the receiver mode, this parameter has no impact on the graphical representation of the frequency axis.

In the analyzer, the command toggles between linear and logarithmic sweep. The frequency axis is represented linearly or logarithmically depending on the sweep.

Example: "SWE:SPAC LOG"

Characteristics: *RST value: LIN
SCPI: conforming

Modes: R, A, VA

The frequency axis is set to linear or logarithmic scaling accordingly.

SENSe:TV Subsystem

This subsystem controls the TV trigger part of option R&S FSP-B6 (TV and RF trigger). The setup of the individual trigger parameters is included in subsystem TRIGger.

COMMAND	PARAMETERS	UNIT	COMMENT
[SENSe<1 2>]			
:TV			Option TV and RF Trigger
[:STATe]	<Boolean>	--	
:CCVS	INTernal EXTernal	--	

[SENSe<1|2>:]TV[:STATe]ON | OFF

This command switches triggering on TV signals on or off.

Example: "TV ON"

Characteristics: *RST value: OFF
SCPI: device-specific

Modes: A-T

This command is only available with option R&S FSP-B6 (TV and RF Trigger).

[SENSe<1|2>:]TV:CCVS INTernal | EXTernal

This command selects between an internal and an external CCVS signal as TV demodulator input signal.

Example: " TV:CCVS EXT "

Characteristics: *RST value: INT
SCPI: device-specific

Modes: A-T

This command is only available with option R&S FSP-B6 (TV and RF Trigger).

SOURce<1|2>:FM:STATE ON | OFF

This command switches on or off the external frequency modulation of the tracking generator in the selected measurement window.

External I/Q modulation is switched off, if active. This command is only valid in conjunction with the tracking generator option B9.

Example: "SOUR:FM:STAT ON" 'Switches on the external frequency modulation of the tracking generator for screen A.

Characteristics: *RST value: OFF
SCPI: conforming

Modes: all

SOURce<1|2>:FM:DEVIation 100Hz to 10MHz

This command defines the maximum frequency deviation at 1 V input voltage at the FM input of the tracking generator.

The possible value range is 100 Hz to 10 MHz in steps of one decade.

This command is only available in connection with the Tracking Generator Option B9.

Example: "SOUR:FM:DEV 1MHz" 'Sets the maximum frequency deviation of the tracking generator for screen A to 1 MHz.

Characteristics: *RST value: 100 Hz
SCPI: conforming

Operating mode: all

SOURce<1|2>:FREQuency:OFFSet -150MHz to 150MHz

This command defines a frequency offset of the tracking generator for the indicated measurement window. Frequency-converting DUTs can be measured with this setting.

The possible value range is -150 MHz to 150 MHz. It should be noted that the terms (start frequency - tracking frequency offset) and (stop frequency - tracking frequency offset) are both > 1 kHz or both < -1 kHz.

External I/Q modulation is switched off, if active. This command is only valid in conjunction with the tracking generator option B9.

Example: "SOUR:FREQ:OFFS 10MHz" 'Switches on the frequency offset of the tracking generator for screen A to 10 MHz.

Characteristics: *RST value: 0 Hz
SCPI: conforming

Modes: all

SOURce<1|2>:POWER[:LEVel][:IMMediate][:AMPLitude] <numeric_value>

This command defines the output level of the tracking generator in the current measurement window.

This command is only valid in conjunction with the tracking generator option B9.

Parameter: <numeric_value> ::= -30 dBm to 5 dBm. (-100 dBm to + 5dBm with option B12)

Example: "SOUR:POW -20dBm" 'Sets the tracking generator level in screen A to -20 dBm.

Characteristics: *RST value: -20 dBm
SCPI: conforming

Modes: all

SOURce:EXTernal Subsystem

The SOURce:EXTernal subsystem controls the operation of the unit with option Ext. Generator Control (B10). The commands are only valid for the selected window, with SOURce1 changing the setting in screen A and SOURce2 the setting in screen B.

The selection of the external generator 1 or 2 is via EXTernal<1|2>.

Note: The commands of the SOURce:EXTernal subsystem assume that the addressed generator was correctly configured with the commands of subsystem SYSTEM:COMMunicate:GPIB:RDEvice:GENerator.

If no external generator is selected, if the IEC bus address is not correct or the generator is not ready for operation, an execution error will be generated.

COMMAND	PARAMETER	UNIT	COMMENT
SOURce<1 2> :EXTernal<1 2> [:STATe]	<Boolean>		Ext. generator option
:FREQuency :OFFSet [:FACTor]	<numeric_value>	HZ	
:NUMerator :DENominator	<numeric_value> <numeric_value>		
:SWEep [:STATe]	<Boolean>		
:POWer [:LEVel]	<numeric_value>	DBM	
:ROSCillator [:SOURce]	INTernal EXTernal		

SOURce<1|2>:EXTernal<1|2>[:STATe] ON | OFF

This command activates or deactivates the external generator selected with SOUR:EXT<1|2>:FREQ:SWE ON in the selected window.

The suffix behind EXTernal is irrelevant for this command.

This command is only available in connection with option Ext. Generator Control B10.

Example:

```
"SYST:COMM:RDEV:GEN1:TYPE 'SMP02'"
'Selects SMP02 as generator 1.
"SYST:COMM:RDEV:GEN1:LINK TTL"
'Selects IECBUS + TTL link as interface.
"SYST:COMM:RDEV:GEN1:ADDR 28"
'Sets the generator address to 28.
"SOUR:EXT1:FREQ:SWE ON"
'Activates the frequency sweep for generator 1.
" SOUR:EXT ON"
'Activates the external generator
```

Characteristics: *RST value: OFF
SCPI: device-specific

Mode: all

SOURce<1|2>:EXTernal<1|2>:FREQUency[:FACTor]:DENominator <numeric_value>

This command defines the denominator of the factor with which the analyzer frequency is multiplied in order to obtain the transmit frequency of the selected generator 1 or 2 in the selected window.

Note: Select the multiplication factor in a way that the frequency range of the generator is not exceeded by the following formula

$$F_{Generator} = F_{Analyzer} * \frac{Numerator}{Denominator} + F_{Offset}$$

if applied to the start and stop frequency of the analyzer.

This command is only valid in combination with option Ext. Generator Control B10.

Example: "SOUR:EXT:FREQ:NUM 4"
 "SOUR:EXT:FREQ:DEN 3" 'Sets a multiplication factor of 4/3, i.e. the 'transmit frequency of the generator is '4/3 times the analyzer frequency.

Characteristics: *RST value: 1
 SCPI: device-specific

Mode: all

SOURce<1|2>:EXTernal<1|2>:FREQUency[:FACTor]:NUMerator <numeric_value>

This command defines the numerator of the factor with which the analyzer frequency is multiplied to obtain the transmit frequency of the selected generator 1 or 2 in the selected window.

Note: Select the multiplication factor so that the frequency range of the generator is not exceeded if the following formula

$$F_{Generator} = F_{Analyzer} * \frac{Numerator}{Denominator} + F_{Offset}$$

is applied to the start and stop frequency of the analyzer.

This command is only valid in combination with option Ext. Generator Control B10.

Example: "SOUR:EXT:FREQ:NUM 4"
 "SOUR:EXT:FREQ:DEN 3" 'Sets a multiplication factor of 4/3, i.e. the 'transmit frequency of the generator is '4/3 times the analyzer frequency.

Characteristics: *RST value: 1
 SCPI: device-specific

Mode: all

SOURce<1|2>:EXTernal<1|2>:FREQUENCY:OFFSet <numeric_value>

This command defines the frequency offset of the selected generator 1 or 2 with reference to the receive frequency in the selected window.

Note: Select the frequency offset of the generator so that the frequency range of the generator is not exceeded with the following formula

$$F_{Generator} = F_{Analyzer} * \frac{Numerator}{Denominator} + F_{Offset}$$

applied to the start and stop frequency of the analyzer.

This command is only valid in combination with option Ext. Generator Control B10.

Example: "SOUR:EXT:FREQ:OFFS 1GHZ" 'Sets a frequency offset of the generator transmit frequency compared to the analyzer receive frequency of 1 GHz.

Characteristics: *RST value: 0 Hz
SCPI: device-specific

Mode: all

SOURce<1|2>:EXTernal<1|2>:FREQUENCY:SWEep[:STATE] ON | OFF

This command activates or deactivates the frequency sweep for generator 1 or 2 in the selected window.

This command is only valid in combination with option Ext. Generator Control B10.

Example: "SOUR:EXT1:FREQ:SWE ON" 'Activates the frequency sweep for ext. generator 1.

Characteristics: *RST value: OFF
SCPI: device-specific

Mode: all

SOURce<1|2>:EXTernal<1|2>:POWER[:LEVel] <numeric_value>

This command sets the output power of the selected generator 1 or 2 in the selected window.

This command is only valid in combination with option Ext. Generator Control B10.

Example: "SOUR:EXT:POW -30dBm" 'Sets the generator level to -30 dBm

Characteristics: *RST value: -20 dBm
SCPI: device-specific

Mode: all

SOURce<1|2>:EXTernal<1|2>:ROSCillator[:SOURce] INTernal | EXTernal

This command switches between external and internal reference oscillator for the frequency processing of external generator 1 and 2.

The command always works on both generators. Therefore, the numeric suffix in EXTernal<1|2> is not significant.

This command is only valid in combination with option Ext. Generator Control B10.

Example: "SOUR:EXT:ROSC EXT" 'switches to external reference oscillator

Characteristics: *RST value: INT
SCPI: device-specific

Mode: all

STATus Subsystem

The STATus subsystem contains the commands for the status reporting system (see Chapter 5, Status Reporting System"). *RST does not influence the status registers.

COMMAND	PARAMETERS	UNIT	COMMENT
STATus			
:OPERation			
[:EVENT?]	--	--	
:CONDition?	--	--	
:ENABLE	0 to 65535	--	
:PTRansition	0 to 65535	--	
:NTRansition	0 to 65535	--	
:PRESet	--	--	
:QUEStionable			
[:EVENT?]	--	--	
:CONDition?	--	--	
:ENABLE	0 to 65535	--	
:PTRansition	0 to 65535	--	
:NTRansition	0 to 65535	--	
:POWer			
[:EVENT?]	--	--	
:CONDition?	--	--	
:ENABLE	0 to 65535	--	
:PTRansition	0 to 65535	--	
:NTRansition	0 to 65535	--	
:LIMit<1 2>			
[:EVENT?]	--	--	
:CONDition?	--	--	
:ENABLE	0 to 65535	--	
:PTRansition	0 to 65535	--	
:NTRansition	0 to 65535	--	
:LMARgin<1 2>			
[:EVENT?]	--	--	
:CONDition?	--	--	
:ENABLE	0 to 65535	--	
:PTRansition	0 to 65535	--	
:NTRansition	0 to 65535	--	
:ACPLimit			
[:EVENT?]	--	--	
:CONDition?	--	--	
:ENABLE	0 to 65535	--	
:PTRansition	0 to 65535	--	
:NTRansition	0 to 65535	--	
:FREQuency			
[:EVENT?]	--	--	
:CONDition?	--	--	
:ENABLE	0 to 65535	--	
:PTRansition	0 to 65535	--	
:NTRansition	0 to 65535	--	

COMMAND	PARAMETERS	UNIT	COMMENT
:SYNC			
[:EVENT?]	--	--	
:CONDition?	--	--	
:ENABle	0 to 65535	--	
:PTRansition	0 to 65535	--	
:TRANsducer		--	
[:EVENT?]	--	--	
:CONDition?	--	--	
:ENABle	0..65535	--	
:PTRansition	0..65535	--	
:NTRansitionSTATus	0..65535	--	
:QUEue	--	--	
[:NEXT?]	--	--	

STATus:OPERation[:EVENT]?

This command queries the contents of the EVENT section of the STATus:OPERation register. The contents of the EVENT section are deleted after readout.

Example: "STAT:OPER?"

Characteristics: *RST value: –
SCPI: conforming

Mode: all

STATus:OPERation:CONDition?

This command queries the CONDition section of the STATus:OPERation register. Readout does not delete the contents of the CONDition section. The value returned reflects the current hardware status.

Example: "STAT:OPER:COND?"

Characteristics: *RST value: –
SCPI: conforming

Mode: all

STATus:OPERation:ENABle 0 to 65535

This command sets the bits of the ENABle section of the STATus:OPERation register. The ENABle register selectively enables the individual events of the associated EVENT section for the summary bit in the status byte.

Example: "STAT:OPER:ENAB 65535"

Characteristics: *RST value: –
SCPI: conforming

Mode: all

STATus:OPERation:PTRansition 0 to 65535

This command sets the edge detectors of all bits of the STATus:OPERation register from 0 to 1 for the transitions of the CONDition bit.

Example: "STAT:OPER:PTR 65535"

Characteristics: *RST value: –
SCPI: conforming

Mode: all

STATus:OPERation:NTRansition 0 to 65535

This command sets the edge detectors of all bits of the STATus:OPERation register from 1 to 0 for the transitions of the CONDition bit.

Example: "STAT:OPER:NTR 65535"
Characteristics: *RST value: –
 SCPI: conforming
Mode: all

STATus:PRESet

This command resets the edge detectors and ENABLE parts of all registers to a defined value. All PTRansition parts are set to FFFFh, i.e. all transitions from 0 to 1 are detected. All NTRansition parts are set to 0, i.e. a transition from 1 to 0 in a CONDition bit is not detected. The ENABLE part of the STATus:OPERation and STATus:QUEStionable registers are set to 0, i.e. all events in these registers are not passed on.

Example: "STAT:PRES"
Characteristics: *RST value: –
 SCPI: conforming
Mode: all

STATus:QUEStionable[:EVENT]?

This command queries the contents of the EVENT section of the STATus:QUEStionable register. The contents of the EVENT section are deleted after the readout.

Example: "STAT:QUES?"
Characteristics: *RST value: –
 SCPI: conforming
Mode: all

STATus:QUEStionable:CONDition?

This command queries the CONDition section of the STATus:QUEStionable register. Readout does not delete the contents of the CONDition section.

Example: "STAT:QUES:COND?"
Characteristics: *RST value: –
 SCPI: conforming
Mode: all

STATus:QUEStionable:ENABle 0 to 65535

This command sets the bits of the ENABle section of the STATus-QUEStionable register. The ENABle register selectively enables the individual events of the associated EVENT section for the summary bit in the status byte.

Example: "STAT:QUES:ENAB 65535"
Characteristics: *RST value: –
 SCPI: conforming
Mode: all

STATus:QUEStionable:PTRansition 0 to 65535

This command sets the edge detectors of all bits of the STATus:QUEStionable register from 0 to 1 for the transitions of the CONDition bit.

Example: "STAT:QUES:PTR 65535"

Characteristics: *RST value: –
SCPI: conforming

Mode: all

STATus:QUEStionable:NTRansition 0 to 65535

This command sets the edge detectors of all bits of the STATus:OPERation register from 1 to 0 for the transitions of the CONDition bit.

Example: "STAT:QUES:NTR 65535"

Characteristics: *RST value: –
SCPI: conforming

Mode: all

STATus:QUEStionable:POWer[:EVENT]?

This command queries the contents of the EVENT section of the STATus:QUEStionable:POWer register. Readout deletes the contents of the EVENT section.

Example: "STAT:QUES?"

Characteristics: *RST value: –
SCPI: conforming

Mode: all

STATus:QUEStionable:POWer:CONDition?

This command queries the contents of the CONDition section of the STATus:QUEStionable:POWer register. Readout does not delete the contents of the CONDition section.

Example: "STAT:QUES:COND?"

Characteristics: *RST value: –
SCPI: conforming

Mode: all

STATus:QUEStionable:POWer:ENABle 0 to 65535

This command sets the bits of the ENABle section of the STATus:QUEStionable:POWer register. The ENABle register selectively enables the individual events of the associated EVENT section for the summary bit.

Example: "STAT:QUES:ENAB 65535"

Characteristics: *RST value: –
SCPI: conforming

Mode: all

STATus:QUEStionable:POWer:PTRansition 0 to 65535

This command sets the edge detectors of all bits of the STATus:QUEStionable:POWer register from 0 to 1 for the transitions of the CONDition bit.

Example: "STAT:QUES:PTR 65535"
Characteristics: *RST value: –
 SCPI: conforming
Mode: all

STATus:QUEStionable:POWer:NTRansition 0 to 65535

This command sets the edge detectors of all bits of the STATus:QUEStionable:POWer register from 1 to 0 for the transitions of the CONDition bit.

Example: "STAT:QUES:NTR 65535"
Characteristics: *RST value: –
 SCPI: conforming
Mode: all

STATus:QUEStionable:LIMit<1|2> [:EVENT]?

This command queries the contents of the EVENT section of the STATus:QUEStionable:LIMit register. Readout deletes the contents of the EVENT section.

Example: "STAT:QUES?"
Characteristics: *RST value: –
 SCPI: device-specific
Mode: all

STATus:QUEStionable:LIMit<1|2>:CONDition?

This command queries the contents of the CONDition section of the STATus:QUEStionable:LIMit register.

Readout does not delete the contents of the CONDition section.

Example: "STAT:QUES:LIM:COND?"
Characteristics: *RST value: –
 SCPI: device-specific
Mode: all

STATus:QUEStionable:LIMit<1|2>:ENABle 0 to 65535

This command sets the bits of the ENABle section of the STATus:QUEStionable register. The ENABle register selectively enables the individual events of the associated EVENT section for the summary bit.

Example: "STAT:QUES:ENAB 65535"
Characteristics: *RST value: –
 SCPI: device-specific
Mode: all

STATus:QUEStionable:LIMit<1|2>:PTRansition 0 to 65535

This command sets the edge detectors of all bits of the STATus:QUEStionable:LIMit register from 0 to 1 for the transitions of the CONDition bit.

Example: "STAT:QUES:PTR 65535"

Characteristics: *RST value: –
SCPI: device-specific

Mode: all

STATus:QUEStionable:LIMit<1|2>:NTRansition 0 to 65535

This command sets the edge detectors of all bits of the STATus:QUEStionable:LIMit register from 1 to 0 for the transitions of the CONDition bit.

Example: "STAT:QUES:NTR 65535"

Characteristics: *RST value: –
SCPI: device-specific

Mode: all

STATus:QUEStionable:LMARgin<1|2> [:EVENT]?

This command queries the contents of the EVENT section of the STATus:QUEStionable:LMARgin register. Readout deletes the contents of the EVENT section.

Example: "STAT:QUES:LMAR?"

Characteristics: *RST value: –
SCPI: device-specific

Mode: all

STATus:QUEStionable:LMARgin<1|2>:CONDition?

This command queries the contents of the CONDition section of the STATus:QUEStionable:LMARgin register. Readout does not delete the contents of the CONDition section.

Example: "STAT:QUES:LMAR:COND?"

Characteristics: *RST value: –
SCPI: device-specific

Mode: all

STATus:QUEStionable:LMARgin<1|2>:ENABle 0 to 65535

This command sets the bits of the ENABle section of the STATus:QUEStionable:LMARgin register. The ENABle register selectively enables the individual events of the associated EVENT section for the summary bit.

Example: "STAT:QUES:LMAR:ENAB 65535"

Characteristics: *RST value: –
SCPI: device-specific

Mode: all

STATus:QUEStionable:LMARgin<1|2>:PTRansition 0 to 65535

This command sets the edge detectors of all bits of the STATus:QUEStionable:LMARgin register from 0 to 1 for the transitions of the CONDition bit.

Example: "STAT:QUES:LMAR:PTR 65535"

Characteristics: *RST value: –
SCPI: device-specific

Mode: all

STATus:QUEStionable:LMARgin<1|2>:NTRansition 0 to 65535

This command sets the edge detectors of all bits of the STATus:QUEStionable:LMARgin register from 1 to 0 for the transitions of the CONDition bit.

Example: "STAT:QUES:LMAR:NTR 65535"

Characteristics: *RST value: –
SCPI: device-specific

Mode: all

STATus:QUEStionable:SYNC[:EVENT]?

This command queries the contents of the EVENT section of the STATus:QUEStionable:SYNC register. Readout deletes the contents of the EVENT section.

Example: "STAT:QUES:SYNC?"

Characteristics: *RST value: –
SCPI: device-specific

Modes: all

STATus:QUEStionable:SYNC:CONDition?

This command queries the contents of the CONDition section of the STATus:QUEStionable:SYNC register. Readout does not delete the contents of the CONDition section.

Example: "STAT:QUES:SYNC:COND?"

Characteristics: *RST value: –
SCPI: device-specific

Modes: all

STATus:QUEStionable:SYNC:ENABle 0 to 65535

This command sets the bits of the ENABle section of the STATus:QUEStionable:SYNC register. The ENABle register selectively enables the individual events of the associated EVENT section for the sum bit in the status byte.

Example: "STAT:QUES:SYNC:ENAB 65535"

Characteristics: *RST value: –
SCPI: device-specific

Modes: all

STATus:QUEStionable:SYNC:PTRansition 0 to 65535

This command sets the edge detectors of all bits of the STATus:QUEStionable: SYNC register from 0 to 1 for the transitions of the CONDition bit.

Example: "STAT:QUES:SYNC:PTR 65535"

Characteristics: *RST value: –
SCPI: device-specific

Modes: all

STATus:QUEStionable:SYNC:NTRansition 0 to 65535

This command sets the edge detectors of all bits of the STATus:QUEStionable: SYNC register from 1 to 0 for the transitions of the CONDition bit.

Example: "STAT:QUES:SYNC:NTR 65535"

Characteristics: *RST value: –
SCPI: device-specific

Modes: all

STATus:QUEStionable:ACPLimit[:EVENT]?

This command queries the contents of the EVENT section of the STATus:QUEStionable:ACPLimit register. Readout deletes the contents of the EVENT section.

Example: "STAT:QUES:ACPL?"

Characteristics: *RST value: –
SCPI: device-specific

Mode: all

STATus:QUEStionable:ACPLimit:CONDition?

This command queries the contents of the CONDition section of the STATus:QUEStionable:ACPLimit register. Readout does not delete the contents of the CONDition section.

Example: "STAT:QUES:ACPL:COND?"

Characteristics: *RST value: –
SCPI: device-specific

Mode: all

STATus:QUEStionable:ACPLimit:ENABLE 0 to 65535

This command sets the bits of the ENABLE section of the STATus:QUEStionable:ACPLimit register. The ENABLE register selectively enables the individual events of the associated EVENT section for the summary bit.

Example: "STAT:QUES:ACPL:ENAB 65535"

Characteristics: *RST value: –
SCPI: device-specific

Mode: all

STATus:QUEStionable:ACPLimit:PTRansition 0 to 65535

This command sets the edge detectors of all bits of the STATus:QUEStionable: ACPLimit register from 0 to 1 for the transitions of the CONDition bit.

Example: "STAT:QUES:ACPL:PTR 65535"

Characteristics: *RST value: –
SCPI: device-specific

Mode: all

STATus:QUEStionable:ACPLimit:NTRansition 0 to 65535

This command sets the edge detectors of all bits of the STATus:QUEStionable: ACPLimit register from 1 to 0 for the transitions of the CONDition bit.

Example: "STAT:QUES:ACPL:NTR 65535"

Characteristics: *RST value: –
SCPI: device-specific

Mode: all

STATus:QUEStionable:FREQuency[:EVENT]?

This command queries the contents of the EVENT section of the STATus:QUEStionable: FREQuency register.

Example: "STAT:QUES:FREQ?"

Characteristics: *RST value: –
SCPI: device-specific

Mode: all

Readout deletes the contents of the EVENT section.

STATus:QUEStionable:FREQuency:CONDition?

This command queries the contents of the CONDition section of the STATus:QUEStionable:FREQuency register. Readout does not delete the contents of the CONDition section.

Example: "STAT:QUES:FREQ:COND?"

Characteristics: *RST value: –
SCPI: device-specific

Mode: all

STATus:QUEStionable:FREQuency:ENABLE 0 to 65535

This command sets the bits of the ENABLE section of the STATus:QUEStionable:FREQuency register. The ENABLE register selectively enables the individual events of the associated EVENT section for the summary bit.

Example: "STAT:QUES:FREQ:ENAB 65535"

Characteristics: *RST value: –
SCPI: device-specific

Mode: all

STATus:QUEStionable:FREQuency:PTRansition 0 to 65535

This command sets the edge detectors of all bits of the STATus:QUEStionable:FREQuency register from 0 to 1 for the transitions of the CONDition bit.

Example: "STAT:QUES:FREQ:PTR 65535"

Characteristics: *RST value: –
SCPI: device-specific

Mode: all

STATus:QUEStionable:FREQuency:NTRansition 0 to 65535

This command sets the edge detectors of all bits of the STATus:QUEStionable:FREQuency register from 1 to 0 for the transitions of the CONDition bit.

Example: "STAT:QUES:FREQ:NTR 65535"

Characteristics: *RST value: –
SCPI: device-specific

Mode: all

STATus:QUEStionable:TRANsducer[:EVENT]?

This command queries the contents of the EVENT section of the STATus:QUEStionable:TRANsducer register. Readout deletes the contents of the EVENT section.

Example: "STAT:QUES:TRAN?"

Characteristics: *RST value: –
SCPI: device-specific

Modes: all

STATus:QUEStionable:TRANsducer:CONDition?

This command queries the contents of the CONDition section of the STATus:QUEStionable:FREQuency register. Readout does not delete the contents of the CONDition section.

Example: "STAT:QUES:TRAN:COND?"

Characteristics: *RST value: –
SCPI: device-specific

Modes: all

STATus:QUEStionable:TRANsducer:ENABle 0 to 65535

This command sets the bits of the ENABle section of the STATus:QUEStionable:TRANsducer register. The ENABle register selectively enables the individual events of the associated EVENT section for the sum bit in the status byte.

Example: "STAT:QUES:TRAN:ENAB 65535"

Characteristics: *RST value: –
SCPI: device-specific

Modes: all

STATus:QUEStionable:TRANsducer:PTRansition 0 to 65535

This command sets the edge detectors of all bits of the STATus:QUEStionable:TRANsducer register from 0 to 1 for the transitions of the CONDition bit.

Example: "STAT:QUES:TRAN:PTR 65535"

Characteristics: *RST value: –
SCPI: device-specific

Modes: all

STATus:QUEStionable:TRANsducer:NTRansition 0 to 65535

This command sets the edge detectors of all bits of the STATus:QUEStionable:TRANsducer register from 1 to 0 for the transitions of the CONDition bit.

Example: "STAT:QUES:TRAN:NTR 65535"

Characteristics: *RST value: –
SCPI: device-specific

Modes: all

STATus:QUEue[:NEXT]?

This command returns the earliest entry to the error queue and deletes it.

Positive error numbers indicate device-specific errors, negative error numbers are error messages defined by SCPI (cf. Chapter 9). If the error queue is empty, the error number 0, "no error", is returned. This command is identical with the command SYSTem:ERRor.

Example: "STAT:QUE?"

Characteristics: *RST value: –
SCPI: conforming

Mode: all

SYSTEM Subsystem

This subsystem contains a series of commands for general functions.

COMMAND	PARAMETERS	UNIT	COMMENT
SYSTem			
:COMMunicate			
:GPIB			
[:SELF]			
:ADDRes	0 to 30	--	
:RTERminator	LFEoi EOI		
:RDEvice			
:GENerator<1 2>			ext. generator option
:ADDRes	0 to 30		ext. generator option
:RDEvice			
:GENerator<1 2>			
:LINK	GPIB TTL		tracking generator option
:TYPE	<name>		tracking generator option
:SERial			
:CONTRol			
:DTR	IBFull OFF		
:RTS	IBFull OFF		
[:RECeive]			
:BAUD	<numeric_value>	--	
:BITS	7 8	--	
:PARity			
[:TYPE]	EVEN ODD NONE		
:SBITs	1 2	--	
:PACE	XON NONE		
:PRINter			
:ENUMerate			
[:NEXT?]			query only
:FIRSt?			query only
:SElect<1 2>	<printer_name>		
:DATE	<num>, <num>, <num>	--	
:DISPlay			
:FPANel	<Boolean>		
:UPDate	<Boolean>		
:ERRor?	--	--	query only
:FIRMware			
:UPDate	<string>		no query
:FIRMware			
:UPDate	<string>		no query
:LANGuage	<string>	--	no query
:PASSword			
[:CENable]	<string>		no query
:PRESet	--	--	no query
:COMPatible	FSP OFF		
:SPEaker		--	
:VOLume	<numeric_value>		
:TIME	0 to 23, 0 to 59, 0 to 59		query only
:VERSion?	--		

SYSTem:COMMunicate:GPIB[:SELF]:ADDRes 0 to 30

This command changes the IEC/IEEE-bus address of the unit.

Example: "SYST:COMM:GPIB:ADDR 18"

Characteristics: *RST value: - (no influence on this parameter, factory default 20)
SCPI: conforming

Mode: all

SYSTEM:COMMunicate:GPIB[:SELF]:RTERminator LFEOI | EOI

This command changes the GPIB receive terminator.

According to the standard the terminator in ASCII is <LF> and/or <EOI>. For binary data transfers (e.g. trace data) from the control computer to the instrument, the binary code (0AH) used for <LF> might be included in the binary data block, and therefore should not be interpreted as a terminator in this particular case. This can be avoided by changing the receive terminator to EOI.

Output of binary data from the instrument to the control computer does not require such a terminator change.

Example: "SYST:COMM:GPIB:RTER EOI"

Characteristics: *RST value: -- (no influence on this parameter, factory default LFEOI)
SCPI: device-specific

Mode: all

SYSTEM:COMMunicate:GPIB:RDEvice:GENerator<1|2>:ADDRess 0 to 30

This command changes the IEC/IEEE-bus address of the device selected as external generator 1 or 2.

Note: *If two generators are connected at the same time to IECBUS 2 their addresses must be different.*

The command is only available with option Ext. Generator Control B10.

Example: "SYST:COMM:GPIB:RDEV:GEN1:ADDR 19" 'Changes the IECBUS address
'of generator 1 to 19

Characteristics: *RST value: 28
SCPI: device-specific

Operating mode: all

SYSTEM:COMMunicate:RDEvice:GENerator<1|2>:LINK GPIB | TTL

This command selects the interface type of the external generator 1 or 2.

The following types are available

- IECBUS alone (= GPIB, for all the generators of other manufacturers and some Rohde & Schwarz units)

or

- IECBUS and TTL interface for synchronization (= TTL, for most of the Rohde & Schwarz generators, see table in command SYSTEM:COMMunicate:RDEvice:GENerator:TYPE).

The difference between the two operating modes is the execution speed. While, during IECBUS operation, each settable frequency is transmitted separately to the generator, a whole frequency list can be programmed in one go if the TTL interface is also used. Frequency switching can then be performed per TTL handshake which results in considerable speed advantages.

Note: *Only one of the two generators can be operated via the TTL interface at a time. The other generator must be configured for IECBUS (GPIB).*

The command is only available with option Ext. Generator Control B10.

Example: "SYST:COMM:RDEV:GEN:LINK TTL" 'Selects IECBUS + TTL interface
'for generator operation

Characteristics: *RST value: GPIB
SCPI: device-specific

Operating mode: all

SYSTEM:COMMunicate:RDEvice:GENERator<1|2>:TYPE <name>

This command selects the type of external generator 1 or 2. The following table shows the available generator types including the associated interface:

Generator	Interface Type	Generator Min Freq	Generator Max Freq	Generator Min Power dBm	Generator Max Power dBm
SME02	TTL	5 kHz	1.5 GHz	-144	+16
SME03	TTL	5 kHz	3.0 GHz	-144	+16
SME06	TTL	5 kHz	6.0 GHz	-144	+16
SMG	GPIB	100 kHz	1.0 GHz	-137	+13
SMGL	GPIB	9 kHz	1.0 GHz	-118	+30
SMGU	GPIB	100 kHz	2.16 GHz	-140	+13
SMH	GPIB	100 kHz	2.0 GHz	-140	+13
SMHU	GPIB	100 kHz	4.32 GHz	-140	+13
SMIQ02B	TTL	300 kHz	2.2 GHz	-144	+13
SMIQ02E	GPIB	300 kHz	2.2 GHz	-144	+13
SMIQ03B	TTL	300 kHz	3.3 GHz	-144	+13
SMIQ03E	GPIB	300 kHz	3.3 GHz	-144	+13
SMIQ04B	TTL	300 kHz	4.4 GHz	-144	+10
SMIQ06B	TTL	300 kHz	6.4 GHz	-144	+10
SML01	GPIB	9 kHz	1.1 GHz	-140	+13
SML02	GPIB	9 kHz	2.2 GHz	-140	+13
SML03	GPIB	9 kHz	3.3 GHz	-140	+13
SMR20	TTL	1 GHz	20 GHz	-130 ²⁾	+11 ²⁾
SMR20B11 ¹⁾	TTL	10 MHz	20 GHz	-130 ²⁾	+13 ²⁾
SMR27	TTL	1 GHz	27 GHz	-130 ²⁾	+11 ²⁾
SMR27B11 ¹⁾	TTL	10 MHz	27 GHz	-130 ²⁾	+12 ²⁾
SMR30	TTL	1 GHz	30 GHz	-130 ²⁾	+11 ²⁾
SMR30B11 ¹⁾	TTL	10 MHz	30 GHz	-130 ²⁾	+12 ²⁾
SMR40	TTL	1 GHz	40 GHz	-130 ²⁾	+9 ²⁾
SMR40B11 ¹⁾	TTL	10 MHz	40 GHz	-130 ²⁾	+12 ²⁾
SMR50	TTL	1 GHz	50 GHz	-130 ²⁾	+9 ²⁾
SMR50B11 ¹⁾	TTL	10 MHz	50 GHz	-130 ²⁾	+12 ²⁾
SMR60	TTL	1 GHz	60 GHz	-130 ²⁾	+9 ²⁾
SMR60B11 ¹⁾	TTL	10 MHz	60 GHz	-130 ²⁾	+12 ²⁾
SMP02	TTL	10 MHz	20 GHz	-130 ³⁾	+17 ³⁾
SMP03	TTL	10 MHz	27 GHz	-130 ³⁾	+13 ³⁾
SMP04	TTL	10 MHz	40 GHz	-130 ³⁾	+12 ³⁾
SMP22	TTL	10 MHz	20 GHz	-130 ³⁾	+20 ³⁾
SMT02	GPIB	5.0 kHz	1.5 GHz	-144	+13
SMT03	GPIB	5.0 kHz	3.0 GHz	-144	+13
SMT06	GPIB	5.0 kHz	6.0 GHz	-144	+13
SMV03	GPIB	9 kHz	3.3 GHz	-140	+13
SMX	GPIB	100 kHz	1.0 GHz	-137	+13
SMY01	GPIB	9 kHz	1.04 GHz	-140	+13
SMY02	GPIB	9 kHz	2.08 GHz	-140	+13
HP8340A	GPIB	10 MHz	26.5 GHz	-110	10
HP8648	GPIB	9 kHz	4 GHz	-136	10
HP ESG-A Series 1000A, 2000A, 3000A, 4000A	GPIB	250 kHz	4 GHz	-136	20
HP ESG-D SERIES E4432B	GPIB	250 kHz	3 GHz	-136	+10

¹⁾ Requires mounting of option SMR-B11.

²⁾ Maximum/Minimum Power depends on the presence of option SMR-B15/-B17 and of the selected frequency range. For details please consult the SMR datasheet.

³⁾ Maximum/Minimum Power depends on the presence of option SMP-B15/-B17 and of the selected frequency range. For details please consult the SMP datasheet.

Notes: Generators with TTL interface can also be operated via IECBUS (= GPIB) alone.

With NONE selected, the corresponding generator 1 or 2 is deactivated.

The command is only available with option Ext. Generator Control B10.

Example: "SYST:COMM:RDEV:GEN2:TYPE 'SME02'" 'Selects SME02 as generator 2.

Characteristics: *RST value: NONE
 SCPI: device-specific

SYSTem:COMMunicate:SERial:CONTrol:DTR IBFull | OFF

SYSTem:COMMunicate:SERial:CONTrol:RTS IBFull | OFF

These commands switch the hardware handshake procedure for the serial interface off (OFF) or on (IBFull).

The two commands are equivalent.

Examples: "SYST:COMM:SER:CONT:DTR OFF"
 "SYST:COMM:SER:CONT:RTS IBF"

Characteristics: *RST value: -- (no influence on this parameter, factory default OFF)
 SCPI: conforming

Mode: all

SYSTem:COMMunicate:SERial[:RECeive]:BAUD 110 | 300 | 600 | 1200 | 2400 | 9600 | 19200

This command sets the transmission speed for the serial interface (COM).

Example: "SYST:COMM:SER:BAUD 2400"

Characteristics: *RST value: -- (no influence on this parameter, factory default 9600)
 SCPI: conforming

Mode: all

SYSTem:COMMunicate:SERial[:RECeive]:BITS 7 | 8

This command defines the number of data bits per data word for the serial interface (COM).

Example: "SYST:COMM:SER:BITS 7"

Characteristics: *RST value: -- (no influence on this parameter, factory default 8)
 SCPI: conforming

Mode: all

SYSTem:COMMunicate:SERial[:RECeive]:PARity[:TYPE] EVEN | ODD | NONE

This command defines the parity check for the serial interface (COM).

Possible values are:
 EVEN even parity
 ODD odd parity
 NONE no parity check.

Example: "SYST:COMM:SER:PAR EVEN"

Characteristics: *RST value: -- (no influence on this parameter, factory default NONE)
 SCPI: conforming

Mode: all

SYSTEM:COMMunicate:SERial[:RECeive]:SBITs 1|2

This command defines the number of stop bits per data word for the serial interface (COM).

Example: "SYST:COMM:SER:SBITS 2"

Characteristics: *RST value: -- (no influence on this parameter, factory default 1)
SCPI: conforming

Mode: all

SYSTEM:COMMunicate:SERial[:RECeive]:PACE XON | NONE

This command switches on or off the software handshake for the serial interface.

Example: "SYST:COMM:SER:PACE XON"

Characteristics: *RST value: -- (no influence on this parameter, factory default NONE)
SCPI: conforming

Mode: all

SYSTEM:COMMunicate:PRINter:ENUMerate:FIRSt?

This command queries the name of the first printer (in the list of printers) available under Windows NT.

The names of other installed printers can be queried with command `SYSTEM:COMMunicate:PRINter:ENUMerate:NEXT?`.

If no printer is configured an empty string is output.

Example: "SYST:COMM:PRIN:ENUM:FIRS?"

Characteristics: *RST value: NONE
SCPI: device-specific

Mode: all

SYSTEM:COMMunicate:PRINter:ENUMerate:NEXT?

This command queries the name of the next printer installed under Windows NT.

The command

`SYSTEM:COMMunicate:PRINter:ENUMerate:FIRSt?`

should be sent previously to return to the beginning of the printer list and query the name of the first printer.

The names of other printers can then be queried with `NEXT?`. After all available printer names have been output, an empty string enclosed by quotation marks (") is output for the next query. Further queries are answered by a Query Error.

Example: "SYST:COMM:PRIN:ENUM:NEXT?"

Characteristics: *RST value: NONE
SCPI: device-specific

Mode: all

SYSTEM:COMMunicate:PRINter:SElect <1|2> <printer_name>

This command selects one of the printers configured under Windows NT including the associated output destination.

The specified printer name must be a string as returned by the commands

SYSTEM:COMMunicate :PRINter:ENUMerate:FIRSt? or
SYSTEM:COMMunicate :PRINter:ENUMerate:NEXT?

Note: Command *HCOpy:DESTination* is used to select an output medium other than the default one.

Example: "SYST:COMM:PRIN:SEL 'LASER on LPT1'"

Characteristics: *RST value: NONE
SCPI: device-specific

Mode: all

SYSTEM:DATE 1980 to 2099, 1 to 12, 1 to 31

This command is used to enter the date for the internal calendar.

The sequence of entry is year, month, day.

Example: " SYST:DATE 2000,6,1"

Characteristics: *RST value: –
SCPI: conforming

Mode: all

SYSTEM:DISPlay:FPANel ON | OFF

This command activates or deactivates the display of the front panel keys on the screen.

With the display activated, the instrument can be operated on the screen using the mouse by pressing the corresponding buttons. This may be useful if the instrument is operated in a detached station by means of a remote program such as PCANYWHERE.

Notes: *With the display of the front panel keys activated, the screen resolution of the unit is set to 1024x768. Thus, only a section of the whole screen is visible on the internal LCD display, which will be moved by mouse moves.*

For a full display of the user interface, an external monitor has to be connected to the rear panel.

When the front panel display is deactivated, the original screen resolution is restored.

Example: "SYST:DISP:FPAN ON"

Characteristics: *RST value: OFF
SCPI: device-specific

Operating mode: all

SYSTEM:DISPlay:UPDate ON | OFF

This command switches on or off the update of all display elements during remote control.

Note: *The best performance is obtained when the display output is switched off during remote control.*

Example: " SYST:DISP:UPD ON"

Characteristics: *RST value: OFF
SCPI: device specific

Mode: all

SYSTEM:ERRor?

This command queries the earliest entry in the error queue, and deletes it after the readout. Positive error numbers indicate device-specific errors, negative error numbers are error messages defined by SCPI (cf. Chapter 9). If the error queue is empty, the error number 0, "no error", is returned. This command is identical with the command `STATus:QUEue:NEXT?`. This command is a query and therefore has no *RST value.

Example: `"SYST:ERR?"`
Characteristics: *RST value: –
 SCPI: conforming
Mode: all

SYSTEM:ERRor:LIST?

This command reads all system messages and returns a list of comma separated strings. Each string corresponds to an entry in the table SYSTEM MESSAGES. If the error list is empty, an empty string "" will be returned. This command is a query and therefore has no *RST value.

Example: `"SYST:ERR:LIST?"`
Characteristics: *RST value: –
 SCPI: device specific
Mode: all

SYSTEM:ERRor:CLEar:ALL

This command deletes all entries in the table SYSTEM MESSAGES. This command is an event and therefore has no query and no *RST value.

Example: `"SYST:ERR:CLE:ALL?"`
Characteristics: *RST value: –
 SCPI: device specific
Mode: all

SYSTEM:FIRMware:UPDate <path>

This command starts a firmware update using the data set in the selected directory. Beforehand, the update files have to be stored in the following subdirectories using command `MMEM:DATA:`

Directory	Contents				
DISK1	_inst32i.ex_	_isdel.exe	_setup.dll	_sys1.cab	_user1.cab
	data.tag	data1.cab	id.txt	lang.dat	layout.bin
	os.dat	Setup.exe	Setup.ini	setup.ins	setup.lid
DISK2	data2.cab				
DISK3	data3.cab				
DISK4	data4.cab				
DISK5	data5.cab				

Example: `"SYST:FIRM:UPD 'D:\USER\FWUPDATE' "`
 'Starts the firmware update from directory
 'D:\USER\FWUPDATE using the files of subdirectories DISK1 to
 DISK5

Characteristics: *RST value: –
 SCPI: device specific
Mode: all

This command is an 'event' and therefore has no query and no *RST value.

SYSTem:LANGuage 'SCPI' | '8566A' | '8566B' | '8568A' | '8568B' | '8594E'

This command activates the emulation of various spectrum analyzers. The analyzer default command set is SCPI.

The following remote-control languages are available:

- SCPI
- 8566A
- 8566B
- 8568A
- 8568B
- 8594E

Note:

- When SCPI is selected, the 8566B/8568B/8594E command set is available in addition.
- When 8566A, 8566B, 8568A or 8568B is selected, both command sets A and B are available, as far as they are supported.

On switching between remote-control languages, the following settings or changes will be made:

SCPI:

The instrument will perform a PRESET.

8566A/B, 8568A/B, 8594E:

The instrument will perform a PRESET.

The following instrument settings will then be changed:

Model	# of Trace Points	Start Freq.	Stop Freq.	Input Coupling
8566A/B	1001	2 GHz	22 GHz	DC (FSU) AC (FSP)
8568A/B	1001	0 Hz	1.5 GHz	AC
8594E	625 (FSU) 501 (FSP)	0 Hz	3 GHz	AC

Notes regarding switchover to 8566A/B and 8568A/B:

- Commands IP and KST, too, will perform the settings for the "# of Trace Points", "Start Freq.", "Stop Freq." and "Input Coupling".
- Switchover of the "# of Trace Points" will not take place until the instrument is switched to the REMOTE mode. For manual operation (selected with LOCAL softkey), the number of sweep points (trace points) will always be set to 1251.
- In the remote mode, the screen area for the measurement will be reduced. The LOCAL softkey (lowermost softkey) will be shifted slightly towards the center of the screen.

Example: "SYST:LANG 'SCPI' "

Characteristics: *RST value: 'SCPI'
SCPI: conforming

Mode: all

There is no query for this command.

SYSTem:PASSword[:CENable] 'password'

This command enables access to the service functions by means of the password.

Example: "SYST:PASS 'XXXX' "

Characteristics: *RST value: –
SCPI: conforming

Mode: all

This command is an event and therefore has no *RST value and no query.

SYSTEM:PRESet

This command initiates an instrument reset.

The effect of this command corresponds to that of the *PRESET* key with manual control or to the *RST command.

Example: "SYST:PRES"
Characteristics: *RST value: –
 SCPI: conforming
Mode: all

SYSTEM:PRESet:COMPAtible FSP | OFF

This command determines if the settings of the receiver after a reset are compatible to the settings of the R&S FSP (selection FSP). If OFF is selected, the receiver specific settings are active after a reset.

Example: "SYST:PRES:COMP FSP"
Characteristics: *RST value: OFF
 SCPI: device-specific
Mode: all

SYSTEM:SPEaker:VOLume 0 to 1

This command sets the volume of the built-in loudspeaker for demodulated signals. Minimum volume is set by 0 and maximum volume by 1.

The value 0 is the lowest volume, the value 1 the highest volume.

Example: "SYST:SPE:VOL 0.5"
Characteristics: *RST value: 0
 SCPI: device-specific
Mode: all

SYSTEM:TIME 0 to 23, 0 to 59, 0 to 59

This command sets the internal clock. The sequence of entry is hour, minute, second.

Example: "SYST:TIME 12,30,30"
Characteristics: *RST value: –
 SCPI: conforming
Mode: all

SYSTEM:VERSion?

This command queries the number of the SCPI version, which is relevant for the instrument.

Example: "SYST:VERS?"
Characteristics: *RST value: –
 SCPI: conforming
Mode: all

This command is a query and therefore has no *RST value.

TRACe Subsystem

The TRACe subsystem controls access to the instrument's internal trace memory.

COMMAND	PARAMETERS	UNIT	COMMENT
TRACe<1 2> [:DATA]	TRACE1 TRACE2 TRACE3 TRACE4 SINGle PHOLd SCAN STATus FINAL1 FINAL2 FINAL3, @<block> <numeric_value>...	-	
:COPY	TRACE1 TRACE2 TRACE3, TRACE1 TRACE2 TRACE3	-	
:IQ			
:AVERage [:STATe]	<Boolean>	--	query only
:COUNT	<numeric_value>	--, --	
:DATA?		--,	
:SET	NORMal <numeric_value>, <numeric_value>, IMMediate EXTernal, IFPower RFPower, POSitive, <numeric_value>, <numeric_value>	HZ, HZ, --, --, --	
:FEED			
:CONTrol	ALWays NEVer		
:SRATe [:STATe]	<Boolean>		
:SYNChronize [:STATe]	<Boolean>		

General Trace Commands

TRACe[:DATA] TRACE1| TRACE2| TRACE3| SINGle | PHOLd | SCAN| STATus | FINAL1 | FINAL1 | FINAL2 | FINAL3 | ABITstream | PWCDp, <block> | <numeric_value>

This command transfers trace data from the control computer to the instrument, the query reads trace data out of the instrument. The associated measurement window is selected with the numeric suffix of TRACe<1|2>.

Note:

If the FM demodulator (option R&S FS-K7) is active, only the displayed trace data is read out and recalled. A portion of the measurement data that can be called by means of a marker, however, is calculated from the raw measurement data. These results are no longer available after recalling a trace; the associated queries generate a query error.

Example: "TRAC TRACE1,"+A\$ (A\$: data list in the current format)
"TRAC? TRACE1"

Characteristics: *RST value: -
SCPI: conforming

Mode: all

Return values:

The returned values are scaled in the current level unit. Returned FM-modulated measurement values (activated option R&S FS-K7) are scaled in Hz.

ASCII format (FORMat ASCII):

In ASCII format, a list of values separated by commas is returned (Comma Separated Values = CSV).

The number of measurement points is 501.

Binary format (FORMat REAL,32):

If the transmission takes place using the binary format (REAL,32), the data are transferred in block format (Definite Length Block Data according to IEEE 488.2). They are arranged in succeeding lists of I and Q data of 32 Bit IEEE 754 floating point numbers. General structure of return string:

```
#42004<meas value 1><meas value value2>...<meas value 501>
```

with

```
#4           digits of the subsequent number of data bytes (4 in the example)
```

```
2004        Number of the subsequent data bytes (2004 in the example)
```

```
<meas value x> 4 byte floating point measurement values
```

Saving and recalling:

Saving and recalling trace data together with the device settings to/from the device-internal hard disk or to/from a floppy is controlled via the commands "MMEMory:STORe:STATe" and

"MMEMory:LOAD:STATe" respectively. Trace data are selected with

"MMEMory:SELEct[:ITEM]:ALL" or "MMEMory:SELEct[:ITEM]:TRACe". Trace data in ASCII format (ASCII FILE EXPORT) are exported with the command "MMEM:STORe:TRACe".

The commands for final measurement data are "MMEMory:SELEct[:ITEM]:FINAl" and "MMEM:STORe:FINAl".

Transfer format:

The trace data are transferred in the current format (corresponding to the command FORMat ASCiI|REAL). The device-internal trace memory is addressed using the trace names 'TRACE1' to 'FINAL3'.

The transfer of trace data from the control computer to the instrument takes place by indicating the trace name and then the data to be transferred. In ASCII format, these data are values separated by commas. If the transfer takes place using the format real (REAL,32), the data are transferred in block format.

The command "MMEMory:STORe:STATe" or "MMEMory:LOAD:STATe" controls the storage or loading of measured data, including the device settings, on or from the internal hard disk or floppy disk. The trace data is selected via "MMEMory:SELEct[:ITEM]:ALL" or "MMEMory:SELEct[:ITEM]:TRACe". The trace data in ASCII format (ASCII FILE EXPORT) is exported via the "MMEM:STORe:TRACe" command.

The parameter of the query is the trace name TRACE1 to FINAL3, it indicates which trace memory will be read out.

Number and format of the measurement values for the different operating modes

The number of measurement values depends on the instrument setting:

SPECTRUM mode (span > 0 and zero span):

501 results are output in the unit selected for display.

Note: *With AUTO PEAK detector, only positive peak values can be read out.
Trace data can be written into the instrument with logarithmic display only in dBm,
with linear display only in volts.*

FORMAT REAL,32 is to be used as format for binary transmission, and FORMAT ASCII for ASCII transmission.

Receiver

Note: *For reasons of compatibility with the EMI test receiver, the data structure of the status information is designed for 4 traces. However, only 3 traces can be activated and transferred.*

SINGLE is possible only as a query for single measurements in the receiver mode. The values of all activated detectors are transferred separated by commas in the following order: POS, NEG, QPE, AVER, RMS. For inactive detectors, the value and the comma are omitted at the position(s) in question.

SCAN is only possible in form of a query during scan measurements. The number of transmitted measurement results depends on the scan settings.

FORMAT REAL,32 is to be used as format setting for binary transmission.

Structure of transmitted data:

- 4 byte: trace status: bit 0 to 9 subscan; bit 10: last block of subscan; Bit 11: last block of last subscan of scan; Bit 12: last of all blocks (for multiple scans after the last scan)
- 4 bytes: number n of the transmitted measurement results of a trace
- 4 byte: trace1 active (0/1)
- 4 byte: trace2 active (0/1)
- 4 byte: trace3 active (0/1)
- 4 byte: reserved
- n*4 bytes: measurement results of trace 1 if trace 1 is active
- n*4 bytes: measurement results of trace 2 if trace 2 is active
- n*4 bytes: measurement results of trace 3 if trace 3 is active
- n*1 byte: status information per measurement result:
bit 0: underrange trace1; bit 1: underrange trace2; bit 2: underrange trace3;
bit 3: overrange trace1 to trace4

STATUS is only possible in form of a query during scan measurements. 1 byte status information per measurement result is transmitted:

bit 0: underrange trace1; bit 1: underrange trace2; bit 2: underrange trace3;
bit 3: overrange trace1 to trace3

FINAL1, FINAL2 and FINAL3 are only possible in form of a query. The final measurement values are transmitted.

TRACe:FEED:CONTrol<1 to 4> ALWays | NEVer

This command switches block data transmission during a scan on and off. The block size depends on the scan time, the trace number is not evaluated.

Example: "TRAC:FEED:CONT ALW"

Features: *RST Value: NEVer
SCPI: conforming

Mode: R

TRACe:COPY TRACe:COPY TRACE1|TRACE2|TRACE3|, TRACE1|TRACE2|TRACE3

This command copies data from one trace to another. The second operand describes the source, the first operand the destination of the data to be copied. The associated measurement window is selected with the numeric suffix of TRACe<1|2>.

Example: "TRAC:COPY TRACE1,TRACE2"

Characteristics: *RST value:
SCPI: conforming

Mode: R, A

This command is an event and therefore has no query and no *RST value.

TRACe:IQ Subsystem

The commands of this subsystem are used for collection and output of measured IQ data. A special memory is therefore available in the instrument with 128k words for the I and Q data. The measurement is always performed in the time domain (span = 0 Hz) at the selected center frequency. The number of samples to be collected can be set. The sample rate can be set in the range from 15.625 kHz to 32 MHz; if channel filters are used, the sample rate is a function of the filter involved and can be determined by a separate command depending on the setting. Prior to being stored in memory or output via GPIB, the measurement data are corrected in terms of frequency response.

Depending on the sample rate, the following maximum bandwidths can be obtained during the measurement.

Sample rate	Max. bandwidth	Notes
32 MHz	9.6 MHz	
16 MHz	7.72 MHz	
8 MHz	4.8 MHz	Signals outside the given bandwidth are folded back into the useful band due to the anti-aliasing filter.
4 MHz	2.8 MHz	
2 MHz	1.6 MHz	max. bandwidth = 0.8 * sample rate for sample rate ≤ 2 MHz
1 MHz	800 kHz	
500 kHz	400 kHz	
250 kHz	200 kHz	
125 kHz	100 kHz	
62.5 kHz	50 kHz	
31.25 kHz	25 kHz	
15.625 kHz	12.5 kHz	

Due to the sampling concept (21.4 MHz IF, 32 MHz Sampling rate), the image frequency is suppressed only by the 10 MHz analog IF filter. When applying an input signal at the edge of the 10 MHz band (+5 MHz from center), the image frequency appears 800 kHz above the input signal.

The image frequency in MHz is calculated as follows:

$$f_{\text{image}} = 2 \cdot (f_{\text{center}} + 5.4 \text{ MHz}) - f_{\text{signal}}$$

where

f_{image} = image frequency in MHz

f_{center} = center frequency in MHz

f_{signal} = frequency of the signal to be measured in MHz

For correct operation the RF input signal shall be limited in bandwidth. Signals more than 5.4 MHz above the center frequency will be mirrored into the 10 MHz pass band.

For additional bandwidth limitation of the measurement data the analog filters (RBW ≥ 300 kHz) are available.

The block diagram below shows the analyzer hardware from the IF section to the processor. The IF filter is the resolution filter of the spectrum analyzer with bandwidths selectable from 300 kHz to 10 MHz. The A/D converter samples the IF signal (20.4 MHz) at a rate of 32 MHz.

The digital signal is down-converted to the complex baseband, lowpass-filtered, and the sampling rate is reduced, i.e. the output sampling rate is set between 15.625 kHz and 32 MHz by dividing the original sampling rate by powers of 2. This avoids unnecessary oversampling at narrower bandwidths, which saves processing time and increases the maximum recording time.

The I/Q data are written to separate memories of 128 k words each (512 k words with option R&S FSP-B70). The memories are hardware-triggered.

Data acquisition hardware

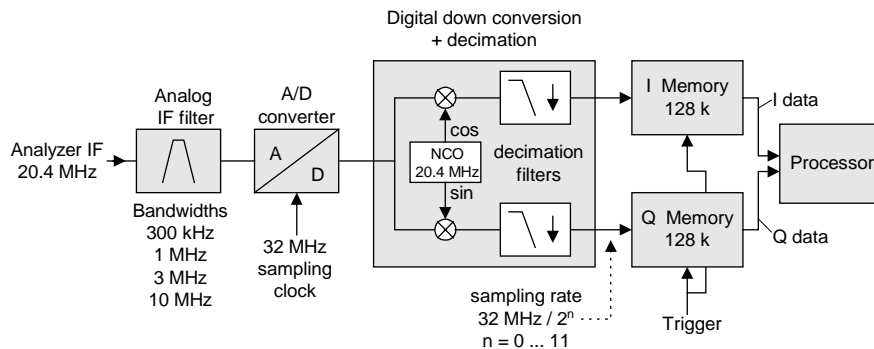

Fig. 6-1 Block diagram illustrating signal processing in analyzer

TRACe<1|2>:IQ:AVERage[:STATe] ON|OFF

The command enables averaging of the recorded I/Q data provided that I/Q data acquisition was previously enabled with TRAC:IQ ON and the sampling rate was set to 32 MHz.

Note: *Averaging is not supported at sampling rates \neq 32 MHz or for a trigger offset < 0 .*

Example:

```

TRAC:IQ ON           'Switches on acquisition of I/Q data.
TRAC:IQ:SYNC ON     'Switches on synchronization of the aquisition of I/Q
                    'measurement data with the trigger time.
TRAC:IQ:SET NORM,10MHz,32MHz,EXT,POS,0,2048
                    ' Reads 2048 I/Q values starting at
                    ' the time of trigger.
                    'Filter type:   NORMAL (analogue)
                    'RBW:           10 MHz
                    'Sample Rate:   32 MHz
                    'Trigger:       external
                    'Slope:         positive

TRAC:IQ:AVER ON     'Enables averaging of the I/Q measurement data.
TRAC:IQ:AVER:COUN 10 'Selects averaging over 10 data sets..
TRAC:IQ:DATA?       'Starts the measurement and reads out the averaged
                    'data.

```

Characteristics: *RST value: OFF
SCPI: device-specific

Mode: A-Z

TRACe<1|2>:IQ:AVERAge:COUNT 0 .. 32767

This command defines the number of I/Q data sets that are to serve as a basis for averaging.

Example:

```
TRAC:IQ ON           'Switches on acquisition of I/Q data.
TRAC:IQ:SYNC ON     'Switches on synchronization of the aquisition of I/Q
                    'measurement data with the trigger time.
TRAC:IQ:SET NORM,10MHz,32MHz,EXT,POS,0,2048
                    'Reads 2048 I/Q values from the
                    'moment of triggering.
                    'Filter type:    NORMAL (analogue)
                    'RBW:           10 MHz
                    'Sample Rate:   32 MHz
                    'Trigger:       external
                    'Slope:         positive

TRAC:IQ:AVER ON     'Enables averaging of the I/Q measurement data
TRAC:IQ:AVER:COUN 10
                    'Selects averaging over 10 data sets
TRAC:IQ:DATA?       'Starts the measurement and reads out the averaged
                    'data.
```

Characteristics: *RST value: 0
SCPI: conforming
Mode: all

TRACe<1|2>:IQ:DATA?

This command starts a measurement with the settings defined via `TRACe:IQ:SET` and returns the list of measurement results immediately after they are corrected in terms of frequency response. The number of measurement results depends on the settings defined with `TRACe:IQ:SET`, the output format depends on the settings of the `FORMat` – subsystem.

Note: *The command requires that all response data are read out completely before the instrument accepts further commands.*

Parameter: none

Example:

```
"TRAC:IQ:STAT ON" 'Enables acquisition of I/Q data
"TRAC:IQ:SET NORM,10MHz,32MHz,EXT,POS,0,4096"
                    'Measurement configuration:
                    'Filtertype:Normal
                    'RBW:10 MHz
                    'Sample Rate:32 MHz
                    'Trigger Source:External
                    'Trigger Slope:Positive
                    'Pretrigger Samples:0
                    '# of Samples:4096

"FORMat REAL,32" 'Selects format of response data
"TRAC:IQ:DATA?" 'Starts measurement and reads results
```

Return values:

The result values are scaled linear in unit *Volt* and correspond to the voltage at the RF input of the instrument.

ASCII Format (FORMat ASCII):

In this case the command returns a comma separated list of the measured voltage values in floating point format (Comma Separated Values = CSV). The number of values returned is 2 * number of samples, the first half being the I-values, the second half the Q-values.

Binary Format (FORMat REAL,32):

In this case the command returns binary data (Definite Length Block Data according to IEEE 488.2), with the lists of I- and Q-data being arranged one after the other in 32 Bit IEEE 754 floating point data. The scheme of the response string is as follows:

#41024<I-value1><I-value2>...<I-value128><Q-value1><Q-value2>...<Q-value128>

with

#4 digits of the subsequent number of data bytes (4 in the example)
 1024 number of subsequent data bytes (# of *DataBytes*, 1024 in the example)
 <I-value x> 4-Byte-Floating Point I-value (max. 128k resp. 512k with option R&S FSP-B70)
 <Q-value y> 4-Byte-Floating Point Q-value (max. 128k resp. 512k with option R&S FSP-B70)

The number of I- and Q-data can be calculated as follows:

$$\# \text{ of } I - \text{Data} = \# \text{ of } Q - \text{Data} = \frac{\# \text{ of } \textit{DataBytes}}{8}$$

The offset of Q-data in the output buffer can be calculated as follows:

$$Q - \text{Data} - \text{Offset} = \frac{(\# \text{ of } \textit{DataBytes})}{2} + \textit{LengthIndicatorDigits}$$

with *LengthIndicatorDigits* being the number of digits of the length indicator including the '#'. In the example above (#41024...) this results in a value of 6 for *LengthIndicatorDigits* and the offset for the Q-data will result in 512 + 6 = 518.

Characteristics: *RST value: --

Note:

Using the command with the *RST values for command TRAC:IQ:SET the following minimum buffer sizes for the response data are recommended:
 ASCII format:10 kBytes
 Binary format:2 kBytes

Mode: SCPI: device specific
 A-T

TRACe<1|2>:IQ:DATA:MEMory? <offset samples>,<# of samples>

This command permits the readout of previously acquired (and frequency response corrected) I/Q data from the memory, with indication of the offset related to the start of measurement and with indication of the number of measurement values. Therefore a previously acquired data set can be read out in smaller portions. The maximum amount of available data depends on the settings of command TRACe: IQ: SET, the output format on the settings in the FORMat – subsystem.

Note: *The command requires that all response data are read out completely before the instrument accepts further commands.*

If there are not I/Q data available in memory because the corresponding measurement had not been started, the command will cause a Query Error.

Parameter:

<offset samples>	Offset of the values to be read related to the start of the acquired data. Value range: 0 to <# of samples> - 1, with <# of samples> being the value indicated with command TRACe: IQ: SET.
<# of samples>	Number of measurement values to be read. Value range: 1 to <# of samples> - <offset samples> with <# of samples> being the value indicated with command TRACe: IQ: SET.

Examples:

"TRAC: IQ: STAT ON"	'Enable acquisition of I/Q data
"TRAC: IQ: SET NORM, 10MHz, 32MHz, EXT, POS, 100, 4096"	'Configure measurement: 'Filter type: Normal 'RBW: 10 MHz 'Sample Rate: 32 MHz 'Trigger Source: External 'Trigger Slope: Positive 'Pretrigger Samples: 100 '# of Samples: 4096
"INIT; *WAI"	'Start measurement and wait for sync
"FORMat REAL, 32"	'Determine output format
'Read results:	
"TRAC: IQ: DATA: MEM? 0, 2048"	'Reads 2048 I/Q data starting at the beginning of data acquisition
"TRAC: IQ: DATA: MEM? 2048, 1024"	'Reads 1024 I/Q data from half of the recorded data
"TRAC: IQ: DATA: MEM? 100, 512"	'Reads 512 I/Q data starting at the trigger point '(<Pretrigger Samples> was 100)

Return values:

The result values are scaled linear in unit *Volt* and correspond to the voltage at the RF input of the instrument.

The format of the output buffer corresponds to the command TRACe: IQ: DATA?

Characteristics: *RST value: --
SCPI: device specific

Mode: A-T

TRACe<1|2>:IQ:SET <filter type>,<rbw>,<sample rate>,<trigger source>,<trigger slope>,<pretrigger samples>,<# of samples>

This command defines the settings of the analyzer hardware for the measurement of I/Q data. This allows setting the bandwidth of the analog filters in front of the A/D converter as well as setting the sample rate, trigger conditions and the record length.

Note: If this command is omitted, the current analyzer settings will be used for the corresponding parameters.

Parameter:

<filter type>: NORMAL 'Selects the analog analyzer resolution filters as filter type. This is currently the only available filter type.

<rbw>: Bandwidth of the analog filters in front of the A/D converter.

<sample rate>: Sampling rate for the data acquisition.

Value range: 15.625 kHz, 31.25 kHz, 62.5 kHz,
125 kHz, 250 kHz, 500 kHz,
1 MHz, 2 MHz, 4 MHz, 8 MHz, 16 MHz,
32 MHz for <filter type> = NORMAl

<trigger mode>: Selection of the trigger source used for the measurement.

Values: IMMEDIATE | EXTERNAL | IFPOWER | RFPower

Notes:

IFPower and RFPower are available as of model 03 of the detector board assembly.

RFPower requires the TV and RF Trigger option R&S FSP-B6.

After selecting IFPower and RFPower, the trigger threshold can be set with command TRIG:LEV:IFP or TRIG:LEV:RFP.

<trigger slope>: Used trigger slope.

Values: POSitive (currently the only value supported)

<pretrigger samples>: Number of measurement values to be recorded before the trigger point.

Range: -16744447
(= $-(2^{24}-1-512k)$) to 65023 (= $64*1024 - 512 - 1$)

Note: Negative values correspond to a trigger delay.
For <trigger mode> = IMMEDIATE the value must be 0.

<# of samples>: Number of measurement values to record.

Value range: 1 to 130560 (= $128*1024 - 512$)

Examples:

"TRAC:IQ:SET NORM,10MHz,32MHz,EXT,POS,0,2048" Reads 2048 I/Q-values starting at the trigger point.

'Filtertype:NORMAL (analog)

'RBW:10 MHz

'Sample Rate:32 MHz

'Trigger:External

'Slope:Positive

"TRAC:IQ:SET NORM,1MHz,4MHz,EXT,POS,1024,512" Reads 512 I/Q-values from 1024 measurement points before the trigger point.

'Filtertype:NORMAL (analog)

'RBW:1 MHz

'Sample Rate:4 MHz

'Trigger:External

'Slope:Positive

Characteristics: *RST values: NORM,3MHz,32MHz,IMM,POS,0,128

Note:

For using these default settings with command TRAC:IQ:DATA? the following minimum buffer sizes for the response data are recommended:

ASCII format:10 kBytes

Binary format:2 kBytes

Mode: SCPI: device specific
A-T

TRACe<1|2>:IQ:SRATe 15.625kHz to 32MHz

This command sets the sampling rate for the I/Q data acquisition. Thus the sample rate can be modified without affecting the other settings.

Value range: 15.625 kHz, 31.25 kHz, 62.5 kHz,
125 kHz, 250 kHz, 500 kHz,
1 MHz, 2 MHz, 4 MHz, 8 MHz, 16 MHz, 32 MHz

Example: "TRAC:IQ:SRAT 4MHZ"

Characteristics: *RST value: 32 MHz
SCPI: device specific

Mode: A-T

TRACe<1|2>:IQ:STATE] ON | OFF

This command switches the I/Q data acquisition on or off.

Note: *The I/Q data acquisition is not compatible with other measurement functions. Therefore all other measurement functions will be switched off as soon as the I/Q measurement function is switched on. Additionally a trace display is not possible in this operating mode. Therefore all traces are set to "BLANK". Finally split screen operation will automatically be stopped.*

Example: TRAC:IQ ON 'Switches on I/Q data acquisition

Characteristics: *RST value: OFF
SCPI: device specific

Mode: A-T

TRACe<1|2>:IQ:SYNChronize[:STATe] ON | OFF

This command switches on or off the synchronization of the start of I/Q data acquisition to the trigger event. Prior to this command, I/Q data acquisition has to be switched. The sampling rate must be 32 MHz. The synchronization ensures the correct calculation of I/Q average values as the data acquisition is always started with the same phase reference in relation to the trigger event.

Note: *This command is not supported for sampling rates other than 32 MHz.*

Example:

"TRAC:IQ ON"	'Switches on I/Q data acquisition
"TRAC:IQ:SYNC ON ON"	'Switches on synchronization of I/Q data acquisition to the trigger event
"TRAC:IQ:SET NORM,10MHz,32MHz,EXT,POS,0,2048"	'Reads 2048 I/Q-values starting at the 'trigger point. 'Filtertype:NORMAL (analog) 'RBW: 10 MHz 'Sample Rate:32 MHz 'Trigger:External 'Slope: Positive
TRAC:IQ:AVER ON	'Enables averaging of the I/Q measurement data
TRAC:IQ:AVER:COUN 10	'Selects averaging over 10 data sets
TRAC:IQ:DATA? "	'Starts the measurement and reads out the averaged 'data.
Characteristics: *RST value:	ON
SCPI:	device specific
Mode:	A-T

VIDeo	=	the next measurement is triggered by the detection of a signal at the video filter output (not available for FM DEMOD mode).
IFPower	=	the next measurement is triggered by the detection of a signal at the instrument IF (10 MHz bandwidth)
RFPower	=	the next measurement is triggered by the detection of a signal at the instrument RF (80 MHz bandwidth)
TV	=	the next measurement is triggered by the detection of a TV signal according to the settings of the TRIGger:SEQuence:VIDeo-subsystem (not available for FM DEMOD mode)
AF FM	=	the next measurement is triggered by the detection of a FM modulated signal (AF is synonymous with FM)
AM	=	the next measurement is triggered by the detection of a audio signal after AM demodulation
PM	=	Triggern der nächsten Messung erfolgt bei Erkennen eines Audio-Signals nach der PM-Demodulation

Note: *To ensure successful triggering with trigger sources AF, AM, FM, and PM the measurement time should include at least 5 periods of the audio signal.*

Example:	"TRIG:SOUR EXT"	'Selects the external trigger input as source of the trigger signal
Characteristics:	*RST value: IMMEDIATE SCPI: conforming	
Mode:	R, A, FM	

TRIGger<1|2>[:SEQuence]:LEVel:AM -100 to +30dBm

The command sets the level when AM-modulated signals are used as a trigger source.

Note: *To ensure successful triggering with trigger sources AF, AM and FM, the measurement time should include at least 5 periods of the audio signal.*

Example:	"TRIG:LEV:AM 10 kHz"	'Sets the AM trigger threshold to 10 kHz
Characteristics:	*RST value: 0 Hz SCPI: device-specific	
Mode:	FM	

This command is only available with option R&S FS-K7 (FM Demodulator) installed.

TRIGger<1|2>[:SEQuence]:LEVel:AF -10 to +10MHz

TRIGger<1|2>[:SEQuence]:LEVel:FM -10 to +10MHz

The command sets the level when FM-modulated signals are used as a trigger source.

Note: *To ensure successful triggering with trigger sources AF, AM and FM, the measurement time should include at least 5 periods of the audio signal.*

Example:	"TRIG:LEV:FM 10 kHz"	'Sets the FM trigger threshold to 10 kHz
Characteristics:	*RST value: 0 Hz SCPI: device-specific	
Mode:	FM	

This command is only available with option R&S FS-K7 (FM Demodulator) installed.

TRIGger<1|2>[:SEQUence]:LEVel:PM -1000...+1000RAD

The command sets the level when PM-modulated signals are used as a trigger source.

Note: *To ensure successful triggering with trigger sources AF, AM FM and PM, the measurement time should include at least 5 periods of the audio signal.*

Example: "TRIG:LEV:PM 1.2 RAD" 'Sets the PM trigger threshold to 1.2 rad

Characteristics: *RST value: 0 RAD
SCPI: device-specific

Mode: FM

This command is only available with option R&S FS-K7 (FM Demodulator) installed.

TRIGger<1|2>[:SEQUence]:LEVel:IFPower -30 to -10DBM

This command sets the level of the IF power trigger source.

Example: "TRIG:LEV:IFP -20DBM"

Characteristics: *RST value: -20 DBM
SCPI: device-specific

Mode: all, except for FM

TRIGger<1|2>[:SEQUence]:LEVel:RFPower -50 to -10DBM

This command sets the level of the RF power trigger source.

Example: "TRIG:LEV:RFP -20DBM"

Characteristics: *RST value: -20 DBM
SCPI: device-specific

Mode: all, except for FM

This command is only available with option R&S FSP-B6 (TV and RF Trigger).

TRIGger<1|2>[:SEQUence]:LEVel:VIDeo 0 to 100PCT

This command sets the level of the video trigger source.

Example: "TRIG:LEV:VID 50PCT"

Characteristics: *RST value: 50 PCT
SCPI: device-specific

Mode: all, except for FM

TRIGger<1|2>[:SEQUence]:HOLDoff -100 to 100s

This command defines the length of the trigger delay.

A negative delay time (pretrigger) can be set in the time domain (span < 0 Hz) only.

Example: "TRIG:HOLD 500us"

Characteristics: *RST value: 0s
SCPI: conforming

Mode: all

TRIGger<1|2>[:SEQuence]:SLOPe POSitive | NEGative

This command selects the slope of the trigger signal. The selected trigger slope applies to all trigger signal sources .

Example: "TRIG:SLOP NEG"
Characteristics: *RST value: POSitive
 SCPI: conforming
Mode: all

TRIGger<1|2>[:SEQuence]:VIDeo:FORMat:LPFRame 525 | 625

This command defines the line system in use (525 or 625 lines) with active TV trigger.

Example: "TRIG:VID:FORM:LPFR 525 "
Characteristics: *RST value:
 SCPI: conforming
Mode: A-T

This command is only available with option R&S FSP-B6 (TV and RF Trigger).

TRIGger<1|2>[:SEQuence]:VIDeo:LINE:NUMBer <numeric_value>

With active TV trigger this command activates triggering at the horizontal sync signal of the indicated line number.

Example: "TRIG:VID:LINE:NUMB 17 "
Characteristics: *RST value:
 SCPI: conforming
Mode: A-T

This command is only available with option R&S FSP-B6 (TV and RF Trigger).

TRIGger<1|2>[:SEQuence]:VIDeo:FIELD:SElect ALL | ODD | EVEN

With active TV trigger this command activates triggering at the vertical sync signal.

The measurement is triggered on both fields with selection ALL, on odd fields with selection ODD and on even fields with selection EVEN.

Example: "TRIG:VID:FIEL:SEL ALL"
Characteristics: *RST value:
 SCPI: conforming
Mode: A-T

This command is only available with option R&S FSP-B6 (TV and RF Trigger).

TRIGger<1|2>[:SEQuence]:VIDeo:SSIGnal:POLarity NEGative | POSitive

With active TV trigger this command selects the polarity of the video sync signal.

Example: "TRIG:VID:SSIG:POL NEG "
Characteristics: *RST value:
 SCPI: conforming
Mode: A-T

This command is only available with option R&S FSP-B6 (TV and RF Trigger).

UNIT Subsystem

The UNIT subsystem is used to switch the basic unit of setting parameters. A distinction is made between UNIT1 (screen A) and UNIT2 (screen B).

COMMAND	PARAMETERS	UNIT	COMMENT
UNIT<1 2> :ANGLE :POWer	DEG RAD DBM V A W DBPW WATT DBUV DBMV VOLT DBPT DBUA AMPere DBUV_M DBUA_M		

UNIT<1|2>:ANGLE DEG | RAD

This command selects the default unit for angles.

Example: "UNIT:ANGL DEG" 'Sets the unit "degree" for screen A.

Characteristics: *RST value: RAD
SCPI: conforming

Mode: FM

UNIT<1|2>:POWER DBM | DBPW | WATT | DBUV | DBMV | VOLT |DBUA | AMPere | DB | DBPT |
DBUV_M | DBUA_M

This command selects the default unit for the selected measurement window.

Example: "UNIT:POW DBUV" 'Sets the power unit for screen A to dBm.

Characteristics: *RST value: DBM
SCPI: conforming

Mode: A

Alphabetical List of Commands

In the following, all remote-control commands are listed with their parameters and page numbers. Generally, they are arranged alphabetically according to the keywords of the command. The list of common commands starts the table.

Command	Parameter	Page
*CAL?		6.4
*CLS		6.4
*ESE	0 to 255	6.4
*ESR?		6.4
*IDN?		6.4
*IST?		6.4
*OPC		6.4
*OPC?		6.4
*OPT?		6.4
*PCB	0 to 30	6.4
*PRE	0 to 255	6.4
*PSC	0 1	6.4
*RST		6.4
*SRE	0 to 255	6.4
*STB?		6.4
*TRG		6.4
*TST?		6.4
*WAI		6.4
ABORt		6.8
CALCulate<1 2>:DELtAmarker<1 to 4>:AOFF		6.10
CALCulate<1 2>:DELtAmarker<1 to 4>:FUNction:FIXed:RPOint:MAX[:PEAK]	!<numeric_value>	6.14
CALCulate<1 2>:DELtAmarker<1 to 4>:FUNction:FIXed:RPOint:X	<numeric_value>	6.15
CALCulate<1 2>:DELtAmarker<1 to 4>:FUNction:FIXed:RPOint:Y		6.14
CALCulate<1 2>:DELtAmarker<1 to 4>:FUNction:FIXed:RPOint:Y:OFFSet	<numeric_value>	6.15
CALCulate<1 2>:DELtAmarker<1 to 4>:FUNction:FIXed[:STATe]	ON OFF	6.14
CALCulate<1 2>:DELtAmarker<1 to 4>:FUNction:PNOise:RESult?		6.16
CALCulate<1 2>:DELtAmarker<1 to 4>:FUNction:PNOise[:STATe]	ON OFF	6.15
CALCulate<1 2>:DELtAmarker<1 to 4>:LINK	ON OFF	6.13
CALCulate<1 2>:DELtAmarker<1 to 4>:MAXimum:LEFT		6.12
CALCulate<1 2>:DELtAmarker<1 to 4>:MAXimum:NEXT		6.12
CALCulate<1 2>:DELtAmarker<1 to 4>:MAXimum:RIGHT		6.12
CALCulate<1 2>:DELtAmarker<1 to 4>:MAXimum[:PEAK]		6.11
CALCulate<1 2>:DELtAmarker<1 to 4>:MINimum:LEFT		6.13
CALCulate<1 2>:DELtAmarker<1 to 4>:MINimum:NEXT		6.13
CALCulate<1 2>:DELtAmarker<1 to 4>:MINimum:RIGHT		6.13
CALCulate<1 2>:DELtAmarker<1 to 4>:MINimum[:PEAK]		6.12
CALCulate<1 2>:DELtAmarker<1 to 4>:MODE	ABSolute RELative	6.10
CALCulate<1 2>:DELtAmarker<1 to 4>:TRACe	1 to 3	6.10
CALCulate<1 2>:DELtAmarker<1 to 4>:X	0 to MAX (frequency sweep time)	6.10
CALCulate<1 2>:DELtAmarker<1 to 4>:X:RELative?		6.11
CALCulate<1 2>:DELtAmarker<1 to 4>:Y?		6.11
CALCulate<1 2>:DELtAmarker<1 to 4>[:STATe]	ON OFF	6.9
CALCulate<1 2>:DLINe<1 2>	MIN .. MAX (depending on current unit)	6.82
CALCulate<1 2>:DLINe<1 2>:STATe	ON OFF	6.82

Command	Parameter	Page
CALCulate<1 2>:FEED	'XTIM:AM' 'XTIM:RFPower[:TDOMain]' 'XTIM:RFPower:AFSPpectrum 'XTIM:FM[:TDOMain]' 'XTIM:FM:AFSPpectrum 'XTIM:PM[:TDOMain]' 'XTIM:PM:AFSPpectrum' 'XTIM:PMSummary<1 to 3>' 'XTIM:SPECTrum' 'XTIM:AMSummary' 'XTIM:FMSummary' 'XTIM:SPECTrum'	6.17
CALCulate<1 2>:FLINE<1 2>	0 to fmax	6.83
CALCulate<1 2>:FLINE<1 2>:STATe	ON OFF	6.83
CALCulate<1 2>:LIMit<1 to 8>:ACPower:ACHannel:ABSolute	-200 to 200 DBM, -200 to 200 DBM	6.23
CALCulate<1 2>:LIMit<1 to 8>:ACPower:ACHannel:ABSolute:STATe	ON OFF	6.24
CALCulate<1 2>:LIMit<1 to 8>:ACPower:ACHannel:RESult?		6.25
CALCulate<1 2>:LIMit<1 to 8>:ACPower:ACHannel[:RELative]	0 to 100 dB, 0 to 100 dB	6.22
CALCulate<1 2>:LIMit<1 to 8>:ACPower:ACHannel[:RELative]:STATe	ON OFF	6.23
CALCulate<1 2>:LIMit<1 to 8>:ACPower:ALTernate<1 2>:ABSolute	-200 to 200 DBM, -200 to 200 DBM	6.28
CALCulate<1 2>:LIMit<1 to 8>:ACPower:ALTernate<1 2>:ABSolute:STATe	ON OFF	6.29
CALCulate<1 2>:LIMit<1 to 8>:ACPower:ALTernate<1 2>:RESult?		6.30
CALCulate<1 2>:LIMit<1 to 8>:ACPower:ALTernate<1 2>[:RELative]	0 to 100 DB, 0 to 100 DB	6.26
CALCulate<1 2>:LIMit<1 to 8>:ACPower:ALTernate<1 2>[:RELative]:STATe	ON OFF	6.27
CALCulate<1 2>:LIMit<1 to 8>:ACPower[:STATe]	ON OFF	6.22
CALCulate<1 2>:LIMit<1 to 8>:CLEar[:IMMEDIATE]		6.20
CALCulate<1 2>:LIMit<1 to 8>:COMMENT	<string>	6.20
CALCulate<1 2>:LIMit<1 to 8>:CONTRol:DOMain	FREQuency TIME	6.31
CALCulate<1 2>:LIMit<1 to 8>:CONTRol:MODE	RELative ABSolute	6.32
CALCulate<1 2>:LIMit<1 to 8>:CONTRol:OFFset	<numeric_value>	6.32
CALCulate<1 2>:LIMit<1 to 8>:CONTRol:SHIFt	<numeric_value>	6.32
CALCulate<1 2>:LIMit<1 to 8>:CONTRol:SPACing	LINear < LOGarithmic	6.32
CALCulate<1 2>:LIMit<1 to 8>:CONTRol[:DATA]	<numeric_value>,<numeric_value>..	6.31
CALCulate<1 2>:LIMit<1 to 8>:COPY	1 to 8 <name>	6.20
CALCulate<1 2>:LIMit<1 to 8>:DELeTe		6.21
CALCulate<1 2>:LIMit<1 to 8>:FAIL?		6.20
CALCulate<1 2>:LIMit<1 to 8>:LOWer[:DATA]	<numeric_value>	6.33
CALCulate<1 2>:LIMit<1 to 8>:LOWer:MARGIn	<numeric_value>	6.34
CALCulate<1 2>:LIMit<1 to 8>:LOWer:MODE	RELative ABSolute	6.34
CALCulate<1 2>:LIMit<1 to 8>:LOWer:OFFset	<numeric_value>	6.34
CALCulate<1 2>:LIMit<1 to 8>:LOWer:SHIFt	<numeric_value>	6.35
CALCulate<1 2>:LIMit<1 to 8>:LOWer:SPACing	LINear LOGarithmic	6.35
CALCulate<1 2>:LIMit<1 to 8>:LOWer:STATe	ON OFF	6.34
CALCulate<1 2>:LIMit<1 to 8>:LOWer:THReshold	<numeric value>	6.35
CALCulate<1 2>:LIMit<1 to 8>:NAME	1 to 8 <string>	6.21
CALCulate<1 2>:LIMit<1 to 8>:STATe	ON OFF	6.19
CALCulate<1 2>:LIMit<1 to 8>:TRACe	1 to 3	6.19
CALCulate<1 2>:LIMit<1 to 8>:UNIT	DBM DBPW WATT DBUV DBMV VOLT DBUA AMPere DB DBT DBUV_M DBUA_M	6.19
CALCulate<1 2>:LIMit<1 to 8>:UPPer[:DATA]	<num_value>,<num_value>..	6.36
CALCulate<1 2>:LIMit<1 to 8>:UPPer:MARGIn	<numeric_value>	6.37
CALCulate<1 2>:LIMit<1 to 8>:UPPer:MODE	RELative ABSolute	6.38
CALCulate<1 2>:LIMit<1 to 8>:UPPer:OFFset	<numeric_value>	6.37
CALCulate<1 2>:LIMit<1 to 8>:UPPer:SHIFt	<numeric_value>	6.38
CALCulate<1 2>:LIMit<1 to 8>:UPPer:SPACing	LINear LOGarithmic	6.38
CALCulate<1 2>:LIMit<1 to 8>:UPPer:SPACing	LINear LOGarithmic	6.38

Command	Parameter	Page
CALCulate<1 2>:LIMit<1 to 8>:UPPer:STATe	ON OFF	6.37
CALCulate<1 2>:LIMit<1 to 8>:UPPer:THReshold	<numeric value>	6.38
CALCulate<1 2>:MARKer<1 to 4>:AOFF		6.40
CALCulate<1 2>:MARKer<1 to 4>:COUNT	ON OFF	6.42
CALCulate<1 2>:MARKer<1 to 4>:COUNT:FREQuency?		6.42
CALCulate<1 2>:MARKer<1 to 4>:COUNT:RESolution	0.1 1 10 100 1000 10000 Hz	6.42
CALCulate<1 2>:MARKer<1 to 4>:COUPled[:STATe]	ON OFF	6.42
CALCulate<1 2>:MARKer<1 to 4>:FUNCTion:ADEMod:AFR[:RES<1 to 3>]?		6.57
CALCulate<1 2>:MARKer<1 to 4>:FUNCTion:ADEM:CARR[:RES<1 to 3>]?		6.58
CALCulate<1 2>:MARKer<1 to 4>:FUNCTion:ADEM:FERR[:RES<1 to 3>]?		6.57
CALCulate<1 2>:MARKer<1 to 4>:FUNCTion:ADEMod:FM[:RES<1 to 3>]?	PPEak MPEak MIDDLE RMS	6.56
CALCulate<1 2>:MARKer<1 to 4>:FUNCTion:ADEMod:PM[:RES<1 to 3>]?	PPEak MPEak MIDDLE RMS	6.56
CALCulate<1 2>:MARKer<1 to 4>:FUNCTion:ADEMod:SINad:RES<1 to 3>?		6.57
CALCulate<1 2>:MARKer<1 to 4>:FUNCTion:ADEMod:THD:RES<1 to 3>?		6.58
CALCulate<1 2>:MARKer<1 to 4>:FUNCTion:CENTer	ON OFF	6.54
CALCulate<1 2>:MARKer<1 to 4>:FUNCTion:CSTep	ON OFF	6.55
CALCulate<1 2>:MARKer<1 to 4>:FUNCTion:DEModulation:CONTInuous	ON OFF99	6.52
CALCulate<1 2>:MARKer<1 to 4>:FUNCTion:DEModulation:HOLDoff	10ms to 1000s	6.52
CALCulate<1 2>:MARKer<1 to 4>:FUNCTion:DEModulation:SElect	AM FM	6.51
CALCulate<1 2>:MARKer<1 to 4>:FUNCTion:DEModulation[:STATe]	ON OFF	6.52
CALCulate<1 2>:MARKer<1 to 4>:FUNCTion:FPEaks:COUNT?		6.48
CALCulate<1 2>:MARKer<1 to 4>:FUNCTion:FPEaks:SORT	X Y	6.49
CALCulate<1 2>:MARKer<1 to 4>:FUNCTion:FPEaks:X?		6.48
CALCulate<1 2>:MARKer<1 to 4>:FUNCTion:FPEaks:Y?		6.49
CALCulate<1 2>:MARKer<1 to 4>:FUNCTion:FPEaks[:IMMEDIATE]	<numeric value>	6.47
CALCulate<1 2>:MARKer<1 to 4>:FUNCTion:MDEPth:RESult?		6.53
CALCulate<1 2>:MARKer<1 to 4>:FUNCTion:MDEPth[:STATe]		6.53
CALCulate<1 2>:MARKer<1 to 4>:FUNCTion:MSUMmary?	<time offset of first pulse>, <measurement time>, <period>, < # of pulses to measure>	6.75
CALCulate<1 2>:MARKer<1 to 4>:FUNCTion:NDBDown	<numeric_value>	6.49
CALCulate<1 2>:MARKer<1 to 4>:FUNCTion:NDBDown:FREQuency?		6.50
CALCulate<1 2>:MARKer<1 to 4>:FUNCTion:NDBDown:RESult?		6.50
CALCulate<1 2>:MARKer<1 to 4>:FUNCTion:NDBDown:STATe	ON OFF	6.49
CALCulate<1 2>:MARKer<1 to 4>:FUNCTion:NDBDown:TIME?		6.50
CALCulate<1 2>:MARKer<1 to 4>:FUNCTion:NOISe:RESult?		6.51
CALCulate<1 2>:MARKer<1 to 4>:FUNCTion:NOISe[:STATe]	ON OFF	6.51
CALCulate<1 2>:MARKer<1 to 4>:FUNCTion:POWer:PRESet	NADC TETRA PDC PHS CDPD CDMA TCDMa NONE	6.63
CALCulate<1 2>:MARKer<1 to 4>:FUNCTion:POWer:RESult:PHZ?	ACPower CPOWer	6.62
CALCulate<1 2>:MARKer<1 to 4>:FUNCTion:POWer:RESult?	ACPower CPOWer MCACpower OBANdwidth OBWidth CN CNO	6.60
CALCulate<1 2>:MARKer<1 to 4>:FUNCTion:POWer:SElect?	ACPower MCACpower CPOWer OBANdwidth OBWidth CN CNO	6.59
CALCulate<1 2>:MARKer<1 to 4>:FUNCTion:POWer[:STATe]	OFF	6.63
CALCulate<1 2>:MARKer<1 to 4>:FUNCTion:REFerence		6.55
CALCulate<1 2>:MARKer<1 to 4>:FUNCTion:STRack:BANdwidth BWIDTH	10 Hz to MAX(SPAN)	6.64
CALCulate<1 2>:MARKer<1 to 4>:FUNCTion:STRack:THReshold	-330 dBm to +30 dBm	6.65
CALCulate<1 2>:MARKer<1 to 4>:FUNCTion:STRack:TRACe	1 to 3	6.65
CALCulate<1 2>:MARKer<1 to 4>:FUNCTion:STRack[:STATe]	ON OFF	6.64
CALCulate<1 2>:MARKer<1 to 4>:FUNCTion:SUMMmary:AOFF		6.74
CALCulate<1 2>:MARKer<1 to 4>:FUNCTion:SUMMmary:AVERage	ON OFF	6.73
CALCulate<1 2>:MARKer<1 to 4>:FUNCTion:SUMMmary:MEAN:AVER:RES?		6.71
CALCulate<1 2>:MARKer<1 to 4>:FUNCTion:SUMMmary:MEAN:PHOL:RES?		6.71
CALCulate<1 2>:MARKer<1 to 4>:FUNCTion:SUMMmary:MEAN:RESult?		6.70

Command	Parameter	Page
CALCulate<1 2>:MARKer<1 to 4>:FUNCTion:SUMMary:MEAN[:STATe]	ON OFF	6.70
CALCulate<1 2>:MARKer<1 to 4>:FUNCTion:SUMMary:MODE	ABSolute RELative	6.74
CALCulate<1 2>:MARKer<1 to 4>:FUNCTion:SUMMary:PHOLd	ON OFF	6.73
CALCulate<1 2>:MARKer<1 to 4>:FUNCTion:SUMMary:PPEak:AVER:RES?		6.68
CALCulate<1 2>:MARKer<1 to 4>:FUNCTion:SUMMary:PPEak:PHOL:RES?		6.68
CALCulate<1 2>:MARKer<1 to 4>:FUNCTion:SUMMary:PPEak:RESult?		6.67
CALCulate<1 2>:MARKer<1 to 4>:FUNCTion:SUMMary:PPEak[:STATe]	ON OFF	6.67
CALCulate<1 2>:MARKer<1 to 4>:FUNCTion:SUMMary:REFerence:AUTO	ONCE	6.74
CALCulate<1 2>:MARKer<1 to 4>:FUNCTion:SUMMary:RMS:AVER:RES?		6.69
CALCulate<1 2>:MARKer<1 to 4>:FUNCTion:SUMMary:RMS:PHOLd:RES?		6.70
CALCulate<1 2>:MARKer<1 to 4>:FUNCTion:SUMMary:RMS:RESult?		6.69
CALCulate<1 2>:MARKer<1 to 4>:FUNCTion:SUMMary:RMS[:STATe]	ON OFF	6.69
CALCulate<1 2>:MARKer<1 to 4>:FUNCTion:SUMMary:SDEV:AVER:RES?		6.72
CALCulate<1 2>:MARKer<1 to 4>:FUNCTion:SUMMary:SDEV:PHOL:RES?		6.73
CALCulate<1 2>:MARKer<1 to 4>:FUNCTion:SUMMary:SDEViation:RESult?		6.72
CALCulate<1 2>:MARKer<1 to 4>:FUNCTion:SUMMary:SDEViation[:STATe]	ON OFF	6.72
CALCulate<1 2>:MARKer<1 to 4>:FUNCTion:SUMMary[:STATe]	ON OFF	6.67
CALCulate<1 2>:MARKer<1 to 4>:FUNCTion:TOI:RESult?		6.54
CALCulate<1 2>:MARKer<1 to 4>:FUNCTion:TOI[:STATe]	ON OFF	6.54
CALCulate<1 2>:MARKer<1 to 4>:FUNCTion:ZOOM	<numeric_value>	6.51
CALCulate<1 2>:MARKer<1 to 4>:LOEXclude	ON OFF	6.43
CALCulate<1 2>:MARKer<1 to 4>:MAXimum:LEFT		6.45
CALCulate<1 2>:MARKer<1 to 4>:MAXimum:NEXT		6.44
CALCulate<1 2>:MARKer<1 to 4>:MAXimum:RIGHT		6.44
CALCulate<1 2>:MARKer<1 to 4>:MAXimum[:PEAK]		6.44
CALCulate<1 2>:MARKer<1 to 4>:MINimum:LEFT		6.46
CALCulate<1 2>:MARKer<1 to 4>:MINimum:NEXT		6.45
CALCulate<1 2>:MARKer<1 to 4>:MINimum:RIGHT		6.46
CALCulate<1 2>:MARKer<1 to 4>:MINimum[:PEAK]		6.45
CALCulate<1 2>:MARKer<1 to 4>:PEXCursion	<numeric_value>	6.46
CALCulate<1 2>:MARKer<1 to 4>:SCOupled[:STATe]	ON OFF	6.43
CALCulate<1 2>:MARKer<1 to 4>[:STATe]	ON OFF	6.39
CALCulate<1 2>:MARKer<1 to 4>:TRACe	1 to 3	6.40
CALCulate<1 2>:MARKer<1 to 4>:X	0 to MAX (frequency sweep time)	6.40
CALCulate<1 2>:MARKer<1 to 4>:X:SLIMits:LEFT	0 to MAX (frequency sweep time)	6.41
CALCulate<1 2>:MARKer<1 to 4>:X:SLIMits:RIGHT	0 to MAX (frequency sweep time)	6.41
CALCulate<1 2>:MARKer<1 to 4>:X:SLIMits[:STATe]	ON OFF	6.40
CALCulate<1 2>:MARKer<1 to 4>:Y:PERCent	0 to 100%	6.44
CALCulate<1 2>:MARKer<1 to 4>:Y?		6.43
CALCulate<1 2>:MATH[:EXPRession][:DEFine]	<expr>	6.76
CALCulate<1 2>:MATH:MODE	LINear LOGarithmic	6.77
CALCulate<1 2>:MATH:POSition	-100PCT to 200PCT	6.76
CALCulate<1 2>:MATH:STATe	ON OFF	6.77
:CALCulate<1 2>:PEAKsearch PSEarch[:IMMediate]		6.78
:CALCulate<1 2>:PEAKsearch PSEarch: METHod	SUBRange PEAK	6.78
:CALCulate<1 2>:PEAKsearch PSEarch:MARGin	MINimum .. MAXimum	6.78
:CALCulate<1 2>:PEAKsearch PSEarch:SUBRanges	1 to 500	6.78
CALCulate:STATistics:APD[:STATe]	ON OFF	6.79
CALCulate:STATistics:CCDF[:STATe]	ON OFF	6.79
CALCulate:STATistics:NSAMples	100 to 1E9	6.79
CALCulate:STATistics:PRESet		6.81
CALCulate:STATistics:Result<1 to 3>?	MEAN PEAK CFACtor ALL	6.81

Command	Parameter	Page
CALCulate:STATistics:SCALE:AUTO	ONCE	6.80
CALCulate:STATistics:SCALE:X:RANGE	-10dB to 200dB	6.80
CALCulate:STATistics:SCALE:X:RLEVel	-130dBm to 30dBm	6.80
CALCulate:STATistics:SCALE:Y:LOWer	-1E-9 to 0.1	6.81
CALCulate:STATistics:SCALE:Y:UPPer	-1E-8 to 1.0	6.80
CALCulate<1 2>:THReshold	MINimum to MAXimum (depending on current unit)	6.82
CALCulate<1 2>:THReshold:STATe	ON OFF	6.83
CALCulate<1 2>:TLINe<1 2>	0 to 1000s	6.83
CALCulate<1 2>:TLINe<1 2>:STATe	ON OFF	6.83
CALCulate<1 2>:UNIT:POWer	DBM V A W DBPW WATT DBUV DBMV VOLT DBUA AMPere DBPT DBUV_M DBUA_M	6.84
CALibration[:ALL]		6.85
CALibration:ABORt		6.85
CALibration:RESult?		6.86
CALibration:STATe	ON OFF	6.86
DIAGnostic<1 2>:SERVice:CSOURce[:POWer]	<numeric_value>	6.88
DIAGnostic<1 2>:SERVice:HWINfo?		6.89
DIAGnostic<1 2>:SERVice:INPut:PULSed:PRATe	10 kHz 100 kHz 200 kHz 500 kHz 1 MHz 2 MHz 4 MHz 6 MHz	6.87
DIAGnostic<1 2>:SERVice:INPut:PULSed[:State]	ON OFF	6.87
DIAGnostic<1 2>:SERVice:INPut[:SElect]	CALibration RF	6.87
DIAGnostic<1 2>:SERVice:NSOURce	ON OFF	6.88
DIAGnostic<1 2>:SERVice:SFUNCTion	<string> to	6.88
DIAGnostic<1 2>:SERVice:STEst:RESult?		6.88
DISPlay:ANNotation:FREQUency	ON OFF	6.92
DISPlay:BARGraph:LEVel:LOWer?		6.98
DISPlay:BARGraph:LEVel:UPPer		6.99
DISPlay:BARGraph:PHOLd	ON OFF	6.99
DISPlay:BARGraph:PHOLd:PRESet		6.99
DISPlay:CMAP<1 to 33>:DEFault<1 2>		6.93
DISPlay:CMAP<1 to 33>:HSL	0 to 1 (tint), 0 to 1 (saturation), 0 to 1 (brightness)	6.93
DISPlay:CMAP<1 to 33>:PDEFined	<color>	6.94
DISPlay:FORmat	SINGle SPLit	6.92
DISPlay:LOGO	ON OFF	6.92
DISPlay:PSAVe:HOLDoff	0 to 60	6.92
DISPlay:PSAVe[:STATe]	ON OFF	6.92
DISPlay[:WINDow<1 2>]:SElect		6.94
DISPlay[:WINDow<1 2>]:SIZE	LARGE SMALL	6.94
DISPlay[:WINDow<1 2>]:TEXT[:DATA]	<string>	6.94
DISPlay[:WINDow<1 2>]:TEXT:STATe	ON OFF	6.95
DISPlay[:WINDow<1 2>]:TIME	ON OFF	6.95
DISPlay[:WINDow<1 2>]:TRACe<1 to 3>:MODE	WRITe VIEW AVERAge MAXHold MINHold	6.98
DISPlay[:WINDow<1 2>]:TRACe<1 to 3>:SYMBOL	CROSSs OFF	6.98
DISPlay[:WINDow<1 2>]:TRACe<1 to 3>:X:SPACing	LINear LOGarithmic	6.95
DISPlay[:WINDow<1 2>]:TRACe<1 to 3>:Y[:SCALE]	10dB to 200dB	6.95
DISPlay[:WINDow<1 2>]:TRACe<1 to 3>:Y[:SCALE]:BOTTom	<numeric_value>	6.97

Command	Parameter	Page
DISPlay[:WINDow<1 2>]:TRACe<1 to 3>:Y[:SCALE]:MODE	ABSolute RELative	6.95
DISPlay[:WINDow<1 2>]:TRACe<1 to 3>:Y[:SCALE]:PDIVision	<numeric_value>	6.97
DISPlay[:WINDow<1 2>]:TRACe<1 to 3>:Y[:SCALE]:RLEVel	-200dBm 130dBm to 30dBm	6.96
DISPlay[:WINDow<1 2>]:TRACe<1 to 3>:Y[:SCALE]:RLEVel:OFFSet	-200dB to 200dB	6.96
DISPlay[:WINDow<1 2>]:TRACe<1 to 3>:Y[:SCALE]:RPOSition	0 to 100 PCT	6.97
DISPlay[:WINDow<1 2>]:TRACe<1 to 3>:Y[:SCALE]:RVALue	<numeric_value>	6.96
DISPlay[:WINDow<1 2>]:TRACe<1 to 3>:Y:SPACing	LINear LOGarithmic	6.97
DISPlay[:WINDow<1 2>]:TRACe<1 to 3>[:STATe]	ON OFF	6.98
FORMat[:DATA]	ASCIi REAL UINT [,32]	6.100
FORMat:DEXPort:DSEParator	POINt COMMa	6.100
HCOPy:ABORt		6.101
HCOPy:CMAp<1 to 33>:DEFault		6.101
HCOPy:CMAp<1 to 33>:HSL	0..1,0..1,0..1	6.102
HCOPy:CMAp<1 to 33>:PDEFined	<color>	6.103
HCOPy:DESTination<1 2>	MMEM' 'SYST:COMM:PRIN' 'SYST:COMM:CLIP'	6.103
HCOPy:DEVice:COLor	ON OFF	6.103
HCOPy:DEVice:LANGUage<1 2>	GDI WMF EWMF BMP	6.104
HCOPy[:IMMediate]		6.104
HCOPy:ITEM:ALL		6.104
HCOPy:ITEM:WINDow<1 2>:TABLe:STATe	ON OFF	6.105
HCOPy:ITEM:WINDow<1 2>:TEXT	<string>	6.105
HCOPy:ITEM:WINDow<1 2>:TRACe:STATe	ON OFF	6.105
HCOPy:PAGE:ORlentation<1 2>	LANDscape PORTRait	6.105
HOLD		6.8
INITiate<1 2>:CONMeas		6.106
INITiate<1 2>:CONTinuous	ON OFF	6.106
INITiate<1 2>[:IMMediate]		6.107
INITiate<1 2>:DISPlay	ON OFF	6.107
INPut<1 2>:ATTenuation	0 to 75dB	6.108
INPut<1 2>:ATTenuation:AUTO	ON OFF	6.109
INPut<1 2>:ATTenuation:PROTection[:STATe]	ON OFF	6.109
INPut:COUPLing	AC DC	6.109
INPut<1 2>:GAIN:AUTO	ON OFF	6.111
INPut<1 2>:GAIN:STATe	ON OFF	6.110
INPut<1 2>:IMPedance	50 75	6.110
INPut<1 2>:LISN:PEARth	GROunded FLOating	6.109
INPut<1 2>:LISN:PHASe	L1 L2 L3 N	6.109
INPut<1 2>:LISN[:TYPE]	TWOPhase FOURphase OFF	6.109
INPut<1 2>:PRESelection[:STATe]	ON OFF	6.111
INPut<1 2>:UPORt:STATe	ON OFF	6.110
INPut<1 2>:UPORt[:VALue]		6.110
INSTRument:CONFigure:MIXed	ON OFF	6.113
INSTRument:CONFigure<1 2>:DISPlay	SANalyzer RECeiver	6.113
INSTRument:COUPLe	NONE RLEVel CF_B CF_A	6.113
INSTRument:COUPLe: BANDwidth BWIDth	ALL NONE	6.114
INSTRument:COUPLe:ATTenuation	ALL NONE	6.114
INSTRument:COUPLe:CENTer	ALL NONE	6.114
INSTRument:COUPLe:DEModulation	ALL NONE	6.114

Command	Parameter	Page
INSTRument:COUPLE:GAIN	ALL NONE	6.114
INSTRument:COUPLE:PRESelector	ALL NONE	6.115
INSTRument:COUPLE:PROTEction	ALL NONE	6.115
INSTRument:COUPLE:SPAN	ALL NONE	6.115
INSTRument<1 2>:NSElect	1 3 6	6.112
INSTRument<1 2>[:SElect]	SANalyzer RECeiver ADEMod	6.112
MMEMemory:CATalog?	Path	6.117
MMEMemory:CDIRectory	directory name	6.117
MMEMemory:CLear:ALL		6.123
MMEMemory:CLear:STATe	1,Path	6.122
MMEMemory:COMMeNt	<string>	6.125
MMEMemory:COpy	path, file name	6.118
MMEMemory:DATA	<file name>,<block data>	6.118
MMEMemory:DELeTe	path, file name	6.119
MMEMemory:INIAlize	'A.'	6.119
MMEMemory:LOAD:AUTO	1,Path	6.120
MMEMemory:LOAD:STATe	path, file name	6.119
MMEMemory:MDIRectory	path	6.120
MMEMemory:MOVE	path, file name	6.120
MMEMemory:MSIS	'A.' 'D.'	6.121
MMEMemory:NAME	path, file name	6.121
MMEMemory:RDIRectory	directory name	6.121
MMEMemory:SElect[:ITEM]:ALL		6.124
MMEMemory:SElect[:ITEM]:DEFault		6.125
MMEMemory:SElect[:ITEM]:FINAl	ON OFF	6.124
MMEMemory:SElect[:ITEM]:HWSettings	ON OFF	6.123
MMEMemory:SElect[:ITEM]:LINes:ALL	ON OFF	6.124
MMEMemory:SElect[:ITEM]:NONE		6.125
MMEMemory:SElect[:ITEM]:SCData	ON OFF	6.124
MMEMemory:SElect[:ITEM]:TRACe[:ACTive]	ON OFF	6.123
MMEMemory:SElect[:ITEM]:TRANsducer:ALL	ON OFF	6.124
MMEMemory:STORe:FINAl	Path	6.122
MMEMemory:STORe<1 2>:STATe	path, file name	6.121
MMEMemory:STORe<1 2>:TRACe	1 to 3,Path	6.122
OUTPut<1 2>[:STATe]	ON OFF	6.126
OUTPut:UPORt:STATe	ON OFF	6.126
OUTPut:UPORt[:VALue]	#B00000000 to #B11111111	6.126
[SENSe:]ADEMod:AF:CENTer	<numeric_value>	6.131
[SENSe:]ADEMod:AF:COUPling	AC DC	6.130
[SENSe:]ADEMod:AF:SPAN	<numeric_value>	6.130
[SENSe:]ADEMod:AF:SPAN:FULL		6.130
[SENSe:]ADEMod:AF:STARt	<numeric_value>	6.131
[SENSe:]ADEMod:AF:STOP	<numeric_value>	6.131
[SENSe:]ADEMod:AM:AFSPectrum:RESult?	<result type>	6.137
[SENSe:]ADEMod:AM:AFSPectrum[:TYPE]	<result type 1>,<result type 2>,<result type 3>	6.136
[SENSe:]ADEMod:AM[:TDOMain]:RESult?	<result type>	6.135
[SENSe:]ADEMod:AM[:TDOMain][:TYPE]	<result type 1>,<result type 2>,<result type 3>	6.134
[SENSe:]ADEMod:BANDwidth BWIDth:DEModulation	<numeric_value>	6.132
[SENSe:]ADEMod:FM:AFSPectrum:RESult?	<result type>	6.141
[SENSe:]ADEMod:FM:AFSPectrum[:TYPE]	<result type 1>,<result type 2>,<result type 3>	6.140

Command	Parameter	Page
[SENSe:]ADEMod:FM:OFFset?	<result type>	6.142
[SENSe:]ADEMod:FM[:TDOMain]:RESult?	<result type>	6.139
[SENSe:]ADEMod:FM[:TDOMain][:TYPE]	<result type 1>,<result type 2>,<result type 3>	6.138
[SENSe:]ADEMod:MTIME	<numeric_value>	6.132
[SENSe:]ADEMod:PM:AFSPectrum:RESult?	<result type>	6.146
[SENSe:]ADEMod:PM:AFSPectrum[:TYPE]	<result type 1>,<result type 2>,<result type 3>	6.145
[SENSe:]ADEMod:PM[:TDOMain]:RESult?	<result type>	6.144
[SENSe:]ADEMod:PM[:TDOMain][:TYPE]	<result type 1>,<result type 2>,<result type 3>	6.143
[SENSe:]ADEMod:RLENgth?		6.132
[SENSe:]ADEMod:SET	<sample rate>,<record length>,<trigger source>,<trigger slope>,<offset samples>,<# of meas>	6.133
[SENSe:]ADEMod:SPEctrum:BANdwidth BWIth[:RESolution]	1 Hz to 10 MHz	6.147
[SENSe:]ADEMod:SPEctrum:OFFset?	<result type>	6.149
[SENSe:]ADEMod:SPEctrum:SPAN:ZOOM	<numeric_value>	6.148
[SENSe:]ADEMod:SPEctrum:SPAN[:MAXimum]	<numeric_value>	6.147
[SENSe:]ADEMod:SPEctrum[:TYPE]	<result type 1>,<result type 2>,<result type 3>	6.148
[SENSe:]ADEMod:SRATe?		6.134
[SENSe:]ADEMod:STATE	ON OFF	6.133
[SENSe<1 2>:]ADEMod:ZOOM:START	0s to measurement time	6.150
[SENSe<1 2>:]ADEMod:ZOOM[:STATe]	ON OFF	6.150
[SENSe<1 2>:]AVERAge:COUNT	0 to 256	6.151
[SENSe<1 2>:]AVERAge[:STATe<1 to 3>]	ON OFF	6.151
[SENSe<1 2>:]AVERAge:TYPE	VIDeo LINear	6.152
[SENSe<1 2>:]BANdwidth BWIth:DEMod	<numeric_value>	6.156
[SENSe<1 2>:]BANdwidth BWIth[:RESolution]	10Hz to 10MHz (analog filter) 1Hz to 30 kHz (FFT filter)	6.153
[SENSe<1 2>:]BANdwidth BWIth[:RESolution]:AUTO	ON OFF	6.154
[SENSe<1 2>:]BANdwidth BWIth[:RESolution]:RATio	0.0001 to 1	6.154
[SENSe<1 2>:]BANdwidth BWIth[:RESolution]:TYPE	NORMal FFT CFILter RRC NOISe PULSe	6.155
[SENSe<1 2>:]BANdwidth BWIth:VIDeo	1Hz to 10MHz	6.155
[SENSe<1 2>:]BANdwidth BWIth:VIDeo:AUTO	ON OFF	6.155
[SENSe<1 2>:]BANdwidth BWIth:VIDeo:RATio	0.01 to 1000	6.155
[SENSe<1 2>:]BANdwidth BWIth:VIDeo:TYPE	LINear LOGarithmic	6.156
[SENSe<1 2>:]CORRection:COLLect[:ACQuire]	THROUGH OPEN	6.158
[SENSe<1 2>:]CORRection:METHod	TRANsmission REFLection	6.157
[SENSe<1 2>:]CORRection:RECall		6.158
[SENSe<1 2>:]CORRection:TRANsdUcer:ADJusT:RLEVel[:STATe]	ON OFF	6.160
[SENSe<1 2>:]CORRection:TRANsdUcer:COMMeNT	<string>	6.159
[SENSe<1 2>:]CORRection:TRANsdUcer:DATA	<freq>,<level>..	6.159
[SENSe<1 2>:]CORRection:TRANsdUcer:DELeTe		6.160
[SENSe<1 2>:]CORRection:TRANsdUcer:SCALing	LINear LOGarithmic	6.159
[SENSe<1 2>:]CORRection:TRANsdUcer:SELeCT	<name>	6.158
[SENSe<1 2>:]CORRection:TRANsdUcer:UNIT	<string>	6.159
[SENSe<1 2>:]CORRection:TRANsdUcer:VIEW	ON OFF	6.160
[SENSe<1 2>:]CORRection:TRANsdUcer[:STATe]	ON OFF	6.159
[SENSe<1 2>:]CORRection:TSET:BReak	ON OFF	6.161
[SENSe<1 2>:]CORRection:TSET:COMMeNT	<string>	6.161
[SENSe<1 2>:]CORRection:TSET:DELeTe		6.162

Command	Parameter	Page
[SENSe<1 2>:]CORRection:TSET:RANGe<1 to 10>	<freq>,<freq>,<name>..	6.161
[SENSe<1 2>:]CORRection:TSET:SElect	<name>	6.160
[SENSe<1 2>:]CORRection:TSET:UNIT	<string>	6.161
[SENSe<1 2>:]CORRection:TSET[:STATe]	ON OFF	6.162
[SENSe<1 2>:]CORRection[:STATe]	ON OFF	6.157
[SENSe<1 2>:]DEMod	OFF AM FM	6.163
[SENSe<1 2>:]DETEctor<1 to 3>[:FUNction]	APEak NEGative POSitive SAMPlE RMS AVERage QPEak CAVerage	6.164
[SENSe<1 2>:]DETEctor<1 to 3>[:FUNction]:AUTO	ON OFF	6.164
:[SENSe<1 2>:]DETEctor<1 to 3>:FMEasurement	NEGative POSitive RMS AVERage QPEak CAVerage CRMS	6.165
[SENSe<1 2>:]DETEctor:RECeiver[:FUNction]	POSitive NEGative RMS AVERage QPEak CAVerage CRMS	6.165
:[SENSe<1 2>:]FMEasurement:AUTO	ON OFF	6.166
:[SENSe<1 2>:]FMEasurement:LISN:PEARth	GROunded FLOating	6.167
:[SENSe<1 2>:]FMEasurement:LISN:PHASe	L1 L2 L3 N	6.167
:[SENSe<1 2>:]FMEasurement:LISN[:TYPE]	TWOPhase FOURphase OFF	6.167
:[SENSe<1 2>:]FMEasurement:NBBB:LEVel	<numeric_value>	6.166
:[SENSe<1 2>:]FMEasurement:NBBB[:STATe]	ON OFF	6.166
:[SENSe<1 2>:]FMEasurement:THReshold[:STATe]	ON OFF	6.166
:[SENSe<1 2>:]FMEasurement:TIME	<numeric_value>	6.167
[SENSe<1 2>:]FREQUency:CENTer	0 GHz to f_{max}	6.168
[SENSe<1 2>:]FREQUency:CENTer:STEP	0 to f_{max}	6.168
[SENSe<1 2>:]FREQUency:CENTer:STEP:LINK	SPAN RBW OFF	6.168
[SENSe<1 2>:]FREQUency:CENTer:STEP:LINK:FACTor	1 to 100 PCT	6.169
[SENSe<1 2>:]FREQUency:MODE	CW FIXed SWEep	6.170
[SENSe<1 2>:]FREQUency:OFFSet	<numeric_value>	6.170
[SENSe<1 2>:]FREQUency:SPAN	0 GHz to f_{max}	6.169
[SENSe<1 2>:]FREQUency:SPAN:FULL		6.169
[SENSe<1 2>:]FREQUency:STARt	0 GHz to f_{max}	6.169
[SENSe<1 2>:]FREQUency:STOP	0 GHz to f_{max}	6.169
[SENSe<1 2>:]LIST:POWer[SEquence]	<analyzer freq>,<ref level>,<rf att>, OFF,<filter type>,<rbw>,<vbw>,<meas time>,<trigger level>, to	6.172
[SENSe<1 2>:]LIST:POWer:SET	<PEAK meas>,<RMS meas>,<AVG meas>, <trigger mode>,<trigger slope>,<trigger offset>, <gate length>	6.175
[SENSe<1 2>:]LIST:POWer:STATe	OFF	6.176
[SENSe<1 2>:]LIST:POWer:RESult		6.176
[SENSe<1 2>:]MPOWer:RESult[:LIST]		6.180
[SENSe<1 2>:]MPOWer:RESult:MIN		6.180
[SENSe<1 2>:]MPOWer[:SEquence]	<analyzer freq>,<rbw>,<meas time>,<trigger source>, <trigger level>,<trigger offset>,<type of meas>,<# of meas>	6.178
[SENSe<1 2>:]POWer:ACHannel:ACPairs	0 to 3	6.182
[SENSe<1 2>:]POWer:ACHannel:BANDwidth BWIDth:ACHannel	100 to 1000MHz	6.183
[SENSe<1 2>:]POWer:ACHannel:BANDwidth BWIDth:ALTErnate<1 2>	100 to 2000MHz	6.183
[SENSe<1 2>:]POWer:ACHannel:BANDwidth BWIDth[:CHANnel]	100 to 1000 MHz	6.183
[SENSe<1 2>:]POWer:ACHannel:MODE	ABSolute RELative	6.183

Command	Parameter	Page
[SENSe<1 2>:]POWer:ACHannel:PRESet	ACPower CPower MCACpower OBANdwidth OBWidth CN CN0	6.185
[SENSe<1 2>:]POWer:ACHannel:PRESet:RLEVel		6.185
[SENSe<1 2>:]POWer:ACHannel:REFerence:AUTO	ONCE	6.184
[SENSe<1 2>:]POWer:ACHannel:REFerence:TXCHannel:AUTO	MINimum MAXimum LHIGhest	6.184
[SENSe<1 2>:]POWer:ACHannel:REFerence:TXCHannel:MANual	1..4	6.184
[SENSe<1 2>:]POWer:ACHannel:SPACing:ALTErnate<1 2>	100 to 2000MHz	6.182
[SENSe<1 2>:]POWer:ACHannel:SPACing:CHANnel	100 to 2000MHz	6.181
[SENSe<1 2>:]POWer:ACHannel:SPACing[:ACHannel]	100 to 2000MHz	6.182
[SENSe<1 2>:]POWer:ACHannel:TXCHannel:COUNT	1..4	6.182
[SENSe<1 2>:]POWer:BANDwidth:BWIDTh	10 to 99.9PCT	6.185
[SENSe<1 2>:]POWer:HSPeEd	ON OFF	6.186
[SENSe<1 2>:]POWer:NCORrection	ON OFF	6.186
[SENSe<1 2>:]POWer:TRACe	1 to 3	6.186
[SENSe<1 2>:]ROSCillator[::INTernal]:TUNe	0 to 4095	6.187
[SENSe<1 2>:]ROSCillator[::INTernal]:TUNe:SAVe		6.187
[SENSe<1 2>:]ROSCillator:SOURce	INTernal EXTernal	6.187
[SENSe<1 2>:]SCAN:RANGes[::COUNT]	1 to 10	6.190
[SENSe<1 2>:]SCAN<1 to 10>:BANDwidth:RESolution	f _{min} to f _{max}	6.189
[SENSe<1 2>:]SCAN<1 to 10>:INPut:ATTenuation	dB _{min} to dB _{max}	6.189
[SENSe<1 2>:]SCAN<1 to 10>:INPut:ATTenuation:AUTO	ON OFF	6.189
[SENSe<1 2>:]SCAN<1 to 10>:INPut:GAIN:AUTO	ON OFF	6.190
[SENSe<1 2>:]SCAN<1 to 10>:INPut:GAIN:STATe	ON OFF	6.189
[SENSe<1 2>:]SCAN<1 to 10>:STARt	f _{min} to f _{max}	6.188
[SENSe<1 2>:]SCAN<1 to 10>:STEP	f _{min} to f _{max}	6.188
[SENSe<1 2>:]SCAN<1 to 10>:STOP	f _{min} to f _{max}	6.188
[SENSe<1 2>:]SCAN<1 to 10>:TIME	100 μs to 100 s	6.189
[SENSe<1 2>:]SWEep:COUNT	0 to 32767	6.192
[SENSe<1 2>:]SWEep:COUNT:CURRent		6.192
[SENSe<1 2>:]SWEep:EGATe	ON OFF	6.192
[SENSe<1 2>:]SWEep:EGATe:HOLDoff	125ns to 100s	6.193
[SENSe<1 2>:]SWEep:EGATe:LENGTh	0 to 100s	6.193
[SENSe<1 2>:]SWEep:EGATe:POLarity	POSitive NEGative	6.193
[SENSe<1 2>:]SWEep:EGATe:SOURce	EXTernal IFPower RFPower	6.193
[SENSe<1 2>:]SWEep:EGATe:TYPE	LEVel EDGE	6.193
[SENSe<1 2>:]SWEep:POINts	125 to 32001	6.194
[SENSe<1 2>:]SWEep:SPACing	LINear LOGarithmic AUTO	6.194
[SENSe<1 2>:]SWEep:TIME	100μs to 100s 15 sec 2,5ms to 16000s 1μs to 16000s	6.191
[SENSe<1 2>:]SWEep:TIME:AUTO	ON OFF	6.191
[SENSe<1 2>:]TV:CCVS	INTernal EXTernal	6.195
[SENSe<1 2>:]TV[::STATe]	ON OFF	6.195
SOURce<1 2>:AM:STATe	ON OFF	6.196
SOURce<1 2>:DM:STATe	ON OFF	6.196
SOURce<1 2>:EXTernal<1 2>:FREQUency:OFFSet	<numeric_value>	6.201
SOURce<1 2>:EXTernal<1 2>:FREQUency:SWEep[::STATe]	ON OFF	6.201
SOURce<1 2>:EXTernal<1 2>:FREQUency[::FACTor]:DENominator	<numeric_value>	6.200
SOURce<1 2>:EXTernal<1 2>:FREQUency[::FACTor]:NUMerator	<numeric_value>	6.200
SOURce<1 2>:EXTernal<1 2>:POWer[::LEVel]	<numeric_value>	6.201
SOURce<1 2>:EXTernal<1 2>:ROSCillator[::SOURce]	INTernal EXTernal	6.201

Command	Parameter	Page
SOURce<1 2>:EXTErnal<1 2>[:STATe]	ON OFF	6.199
SOURce<1 2>:FM:DEVIation	100Hz to 10MHz	6.197
SOURce<1 2>:FM:STATe	ON OFF	6.197
SOURce<1 2>:FREQuency:OFFSet	-150 MHz to 150 MHz	6.197
SOURce<1 2>:POWer[:LEVel][:IMMEDIATE]:OFFSet	-200 dB to +200 dB	6.198
SOURce<1 2>:POWer[:LEVel][:IMMEDIATE][:AMPLitude]	<numeric_value>	6.197
STATus:OPERation:CONDition?		6.203
STATus:OPERation:ENABle	0 to 65535	6.203
STATus:OPERation:NTRansition	0 to 65535	6.204
STATus:OPERation:PTRansition	0 to 65535	6.203
STATus:OPERation[:EVENT]?		6.203
STATus:PRESet		6.204
STATus:QUEStionable:ACPLimit:CONDition?		6.209
STATus:QUEStionable:ACPLimit:ENABle	0 to 65535	6.209
STATus:QUEStionable:ACPLimit:NTRansition	0 to 65535	6.210
STATus:QUEStionable:ACPLimit:PTRansition	0 to 65535	6.210
STATus:QUEStionable:ACPLimit[:EVENT]?		6.209
STATus:QUEStionable:CONDition?		6.204
STATus:QUEStionable:ENABle	0 to 65535	6.204
STATus:QUEStionable:FREQuency:CONDition?		6.210
STATus:QUEStionable:FREQuency:ENABle	0 to 65535	6.210
STATus:QUEStionable:FREQuency:NTRansition	0 to 65535	6.211
STATus:QUEStionable:FREQuency:PTRansition	0 to 65535	6.211
STATus:QUEStionable:FREQuency[:EVENT]?		6.210
STATus:QUEStionable:LIMit:CONDition?		6.206
STATus:QUEStionable:LIMit:ENABle	0 to 65535	6.206
STATus:QUEStionable:LIMit:NTRansition	0 to 65535	6.207
STATus:QUEStionable:LIMit:PTRansition	0 to 65535	6.207
STATus:QUEStionable:LIMit[:EVENT]?		6.206
STATus:QUEStionable:LMARgin:CONDition?		6.207
STATus:QUEStionable:LMARgin:ENABle	0 to 65535	6.207
STATus:QUEStionable:LMARgin:NTRansition	0 to 65535	6.208
STATus:QUEStionable:LMARgin:PTRansition	0 to 65535	6.208
STATus:QUEStionable:LMARgin[:EVENT]?		6.207
STATus:QUEStionable:NTRansition	0 to 65535	6.205
STATus:QUEStionable:POWer:CONDition?		6.205
STATus:QUEStionable:POWer:ENABle	0 to 65535	6.205
STATus:QUEStionable:POWer:NTRansition	0 to 65535	6.206
STATus:QUEStionable:POWer:PTRansition	0 to 65535	6.206
STATus:QUEStionable:POWer[:EVENT]?		6.205
STATus:QUEStionable:PTRansition	0 to 65535	6.205
STATus:QUEStionable:SYNC:CONDition?		6.208
STATus:QUEStionable:SYNC:ENABle	0 to 65535	6.208
STATus:QUEStionable:SYNC:NTRansition	0 to 65535	6.209
STATus:QUEStionable:SYNC:PTRansition	0 to 65535	6.209
STATus:QUEStionable:SYNC[:EVENT]?		6.208
STATus:QUEStionable:TRANsducer:CONDition?		6.211
STATus:QUEStionable:TRANsducer:ENABle	0 to 65535	6.211
STATus:QUEStionable:TRANsducer:NTRansition	0 to 65535	6.212
STATus:QUEStionable:TRANsducer:PTRansition	0 to 65535	6.212
STATus:QUEStionable:TRANsducer[:EVENT]?		6.211
STATus:QUEStionable[:EVENT]?		6.204
STATus:QUEue[:NEXT]?		6.212

Command	Parameter	Page
SYSTem:COMMunicate:GPIB:RDEvice:GENerator<1 2>:ADDRess	0 to 30	6.214
SYSTem:COMMunicate:GPIB:RDEvice:GENerator<1 2>:LINK	GPIB TTL	6.214
SYSTem:COMMunicate:GPIB:RDEvice:GENerator<1 2>:TYPE	<name>	6.215
SYSTem:COMMunicate:GPIB[:SELF]:ADDRess	0 to 30	6.213
SYSTem:COMMunicate:GPIB[:SELF]:RTERminator	LFEOI EOI	6.214
SYSTem:COMMunicate:PRINter:ENUMerate:FIRSt?		6.217
SYSTem:COMMunicate:PRINter:ENUMerate:NEXt?		6.217
SYSTem:COMMunicate:PRINter:SElect	<printer_name>	6.218
SYSTem:COMMunicate:SERial:CONTRol:DTR	IBFull OFF	6.216
SYSTem:COMMunicate:SERial:CONTRol:RTS	IBFull OFF	6.216
SYSTem:COMMunicate:SERial[:RECeive]:BAUD	110 300 600 1200 2400 9600 19200	6.216
SYSTem:COMMunicate:SERial[:RECeive]:BITS	7 8	6.216
SYSTem:COMMunicate:SERial[:RECeive]:PACE	XON NONE	6.217
SYSTem:COMMunicate:SERial[:RECeive]:PARity[:TYPE]	EVEN ODD NONE	6.216
SYSTem:COMMunicate:SERial[:RECeive]:SBITs	1 2	6.217
SYSTem:DATE	1980 to 2099, 1 to 12, 1 to 31	6.218
SYSTem:DISPlay:FPANel	ON OFF	6.218
SYSTem:ERRor:CLEar:ALL		6.219
SYSTem:ERRor:LIST?		6.219
SYSTem:ERRor?		6.219
SYSTem:FIRMware:UPDate	<path>	6.219
SYSTem:LANGUage	'SCPI' '8566A' '8566B' '8568A' '8568B' '8594E'	6.220
SYSTem:PASSword[:CENable]	'password'	6.220
SYSTem:PRESet		6.221
SYSTem:PRESet:COMPAtible	FSP OFF	6.221
SYSTem:SPEaker:VOLume	0 to 1	6.221
SYSTem:TIME	0 to 23, 0 to 59, 0 to 59	6.221
SYSTem:UPDate	ON OFF	6.218
SYSTem:VERSion?		6.221
TRACe:COPIY	TRACE1 TRACE2 TRACE3 TRACE4 ,TRACE1 TRACE2 TRACE3 TRACE4	6.225
TRACe[:DATA]	TRACE1 TRACE2 TRACE3 TRACE4 SINGLE PHOLd SCAN STATus FINAL1 FINAL2 FINAL3 ABITstream PWCDp, <block> <numeric_value>	6.222
TRACe<1 2>:IQ:AVERage:COUNT	0 to 32767	6.227
TRACe<1 2>:IQ:AVERage[:STATe]	ON OFF	6.226
TRACe<1 2>:IQ:DATA:MEMory?	<offset samples>, <# of samples>, <filter type>, <rbw>, <sample rate>, <trigger source>, <trigger slope>, <pretrigger samples>, <# of samples>	6.229
TRACe<1 2>:IQ:SRATe	16kHz to 32MHz	6.231
TRACe<1 2>:IQ[:STATe]	ON OFF	6.231
TRACe<1 2>:IQ:SYNChronize[:STATe]	ON OFF	6.232
TRIGger<1 2>[:SEQUence]:HOLDoff	-100 to 100 s	6.235
TRIGger<1 2>[:SEQUence]:LEVel:AF	-10 to +10MHz	6.234
TRIGger<1 2>[:SEQUence]:LEVel:AM	-100 to +30dBm	6.234
TRIGger<1 2>[:SEQUence]:LEVel:FM	-10 to +10MHz	6.234
TRIGger<1 2>[:SEQUence]:LEVel:IFPower	-30 to -10 DBM	6.235
TRIGger<1 2>[:SEQUence]:LEVel:RFPower	-50 to -10 DBM	6.235
TRIGger<1 2>[:SEQUence]:LEVel:VIDeo	0 to 100 PCT	6.235

Command	Parameter	Page
TRIGger<1 2>[:SEQuence]:SLOPe	POSitive NEGative	6.236
TRIGger<1 2>[:SEQuence]:SOURce	IMMediate EXTernal VIDeo IFPower RFPower TV AF	6.233
TRIGger<1 2>[:SEQuence]:VIDeo:FIELD:SElect	ALL ODD EVEN	6.236
TRIGger<1 2>[:SEQuence]:VIDeo:FORMat:LPFRame	525 625	6.236
TRIGger<1 2>[:SEQuence]:VIDeo:LINE:NUMBer	<numeric_value>	6.236
TRIGger<1 2>[:SEQuence]:VIDeo:SSIGnal:POLarity	NEGative POSitive	6.236
UNIT:ANGLE	DEG RAD	6.237
UNIT:POWER	DBM DBPW WATT DBUV DBMV VOLT DBUA AMPere DB DBT DBUV_M DBUA_M DBUV_M DBUA_M	6.237

IEC/IEEE-Bus Commands of HP Models 856xE, 8566A/B, 8568A/B and 8594E

Introduction

The R&S ESCI supports a subset of the IEC/IEEE-bus commands of HP models 8560E, 8561E, 8562E, 8563E, 8564E, 8565E, 8566A, 8566B, 8568A, 8568B and 8594E (spectrum analyzers).

Despite the differences in system architecture and device features, the supported commands have been implemented to ensure a sufficiently high degree of correspondence with the original.

This includes the support of syntax rules for not only newer device families (B and E models) but for the previous A family as well.

The selection of commands supported by the R&S ESCI is largely sufficient to run an existing IEC/IEEE-bus program without any adaptation.

The device model to be emulated is selected manually by means of the key sequence *SETUP - GENERAL SETUP - GPIB - GPIB LANGUAGE* via the IEC/IEEE bus using the *SYSTem:LANGUage* command.

To make it possible to also emulate device models that are not part of the selection list of the GPIB LANGUAGE softkey, the identification string received in response to the ID command can be modified (key sequence *SETUP - GENERAL SETUP - GPIB - ID STRING USER*). This allows any device model to be emulated whose command set is compatible with one of the supported device models.

Command Set of Models 8560E, 8561E, 8562E, 8563E, 8564E, 8565E, 8566B, 8568B and 8594E E

As with the original units, the R&S ESCI includes the command set of the A models in the command set of the B models. To avoid any ambiguity, the commands of the A models are listed in a separate section.

Function Category	Function	HP 856xE / HP 8566B / HP 8568B / HP 8594E Command	Supported Command Subset	Known Differences
Amplitude				
	Attenuation	AT	AT <numeric_value> DB DM AT DN AT UP AT AUTO AT?	AT DN/UP: Step sizes if option R&S FSP-B25 is fitted. AT AUTO: Dependency calculation
	Amplitude Units	AUNITS	AUNITS DBM DBMV DBUV AUNITS?	CALC:UNIT:POW
	Input Impedance	INZ ¹⁾	INZ 75 INZ 50 INZ?	INP:IMP
	Amplitude Scale Log	LG	LG <numeric_value> DB DM LG?	DISP:WIND:TRAC:Y:SCAL <number> dB;SCAL:SPAC LOG
	Amplitude Scale Lin	LN	LN	DISP:WIND:TRAC:Y:SCAL :SPAC LIN

¹⁾ HP8594E only

Function Category	Function	HP 856xE / HP 8566B / HP 8568B / HP 8594E Command	Supported Command Subset	Known Differences
	Reference Level	RL	RL <numeric_value> DB DM RL DN RL UP RL?	Step size and default value
	Reference Level Position	RLPOS ¹⁾	RLPOS <numeric_value> RLPOS DN RLPOS UP RLPOS?	On the R&S ESCI, this function affects the reference level position also if tracking generator normalization is inactive.
	Reference Level Offset	ROFFSET	ROFFSET <numeric_value> DB DM ROFFSET?	DISP:WIND:TRAC:Y:RLEV:OFFS <number> dB
Auxiliary Control				
	AF Demodulator	DEM ¹⁾	DEM ON OFF AM FM	
	Normalized Reference Level	NRL ¹⁾	NRL <numeric_value> DB DM NRL?	Requires option R&S FSP-B9 or R&S FSP-B10.
	Source Normalization	SRCNORM ¹⁾	SRCNORM ON OFF SRCNORM 1 0	Requires option R&S FSP-B9 or R&S FSP-B10.
	Source Power Offset	SRCPOFS ¹⁾	SRCPOFS <numeric_value> DB DM SRCPOFS DN SRCPOFS UP SRCPOFS?	Requires option R&S FSP-B10.
	Source Power	SRCPWR ¹⁾	SRCPWR <numeric_value> DB DM SRCPWR DN SRCPWR UP SRCPWR ON SRCPWR OFF SRCPWR?	Requires option R&S FSP-B9 or R&S FSP-B10.
Bandwidth				
	Resolution Bandwidth	RB	RB <numeric_value> HZ KHZ MHZ GHZ RB DN RB UP RB AUTO RB?	Range of values Formula for dependent parameters (video bandwidth, sweeptime)
	Video Bandwidth	VB	VB <numeric_value> HZ KHZ MHZ GHZ VB DN VB UP VB AUTO VB?	Range of values Formula for dependent parameters (sweeptime)
	Video Bandwidth Ratio	VBR ¹⁾	VBR <numeric_value> VBR DN VBR UP VBR?	Default value
Calibration				
	Start Analyzer Self Alignment	CAL ¹⁾	CAL ALL CAL ON CAL OFF	The CAL commands do not automatically set the command complete bit (bit 4) in the status byte. An additional DONE is required for that purpose.

¹⁾ HP8594Eonly

Function Category	Function	HP 8590 Command	Supported Command Subset	Known Differences
Configuration				
	Time Display	TIMEDSP ¹⁾	TIMEDSP ON OFF TIMEDSP 1 0 TIMEDSP?	
Display				
	Annotation	ANNOT	ANNOT ON OFF ANNOT 1 0 ANNOT?	Only frequency axis annotation is affected.
	Threshold	TH	TH <numeric_value> DB DM TH DN TH UP TH ON TH OFF TH AUTO TH?	Default value is different. Threshold line has no effect on trace data (TH AUTO is always active).
Frequency				
	Center Frequency	CF	CF <numeric_value> HZ KHZ MHZ GHZ CF UP CF DN CF?	Default value Range Step size
	Start Frequency	FA	FA <numeric_value> HZ KHZ MHZ GHZ FA UP FA DN FA?	Range Step size
	Stop Frequency	FB	FB <numeric_value> HZ KHZ MHZ GHZ FB UP FB DN FB?	Default value Range Step size
	Frequency Offset	FOFFSET ¹⁾	FOFFSET <numeric_value> HZ KHZ MHZ GHZ FOFFSET?	
	CF Step Size	SS	SS <numeric_value> HZ KHZ MHZ GHZ SS DN SS UP SS AUTO SS?	Step size
Information				
	Clear All Status Bits	CLS ¹⁾	CLS	
	Identify	ID	ID ID?	
	Firmware revision	REV	REV REV?	
	Service Request Bit Mask	RQS	RQS	Bits supported: 1 (units key pressed) 2 (end of sweep) 3 (device error) 4 (command complete) 5 (illegal command)

¹⁾ HP8594E only

Function Category	Function	HP 8590 Command	Supported Subset	Known differences
	Status Byte Query	STB	STB	Status bits will be mapped as stated under RQS <i>Note:</i> <i>Bits 2 and 4 will always be set together if "Command Complete" or "End of Sweep" is detected. The R&S ESCI cannot distinguish between these two conditions. Plus, these bits cannot be used for synchronization at the end of the sweep in the continuous sweep mode.</i> The status byte obtained by a serial poll will always conform to IEEE 488.2 / SCPI.
	ERR?			Deletes the error bit in the status register but always returns a '0' in response.
Marker				
	Delta Marker	MKD	MKD MKD <numeric_value> HZ KHZ MHZ GHZ MKD DN MKD UP MKD ON MKD OFF MKD?	
	Marker Frequency Query	MF	MF MF?	
	Set Marker Frequency	MKF	MKF <numeric_value> HZ KHZ MHZ GHZ MKF?	
	Marker Amplitude	MKA	MKA?	
	Select the Active Marker	MKACT	MKACT 1 MKACT?	Only marker 1 is supported as the active marker.
	N dB Down	MKBW ¹⁾	MKBW <numeric_value> MKBW ON MKBW OFF	Different default value.
	Frequency Counter Resolution	MKFCR ¹⁾	MKFCR <numeric_value> HZ KHZ MHZ GHZ MKFCR DN MKFCR UP MKFCR?	
	Marker -> Min	MKMIN	MKMIN	
	Normal Marker	MKN	MKN MKN <numeric_value> HZ KHZ MHZ GHZ MKN DN MKN UP MKN ON MKN OFF MKN?	
	Noise Measurement	MKNOISE	MKNOISE ON OFF MKNOISE 1 0 MKNOISE?	
	Marker Off	MKOFF	MKOFF MKOFF ALL	

¹⁾ HP8594E only

Function Category	Function	HP 8590 Command	Supported Command Subset	Known Differences
	Marker Search	MKPK	MKPK MKPK HI MKPK NH MKPK NR MKPK NL	
	Marker Peak Threshold	MKPT	MKPT MKPT HI MKPT NH MKPT NR MKPT NL	Different step size
	Peak Excursion	MKPX	MKPX <numeric_value> DB MKPX DN MKPX UP MKPX?	Different step size
	Ref Level = Marker Level	MKRL	MKRL	
	CF Stepsize = Marker Freq	MKSS	MKSS	
	Marker to Trace	MKTRACE	MKTRACE TRA TRB TRC	
	Signal Track	MKTRACK	MKTRACK ON OFF MKTRACK 1 0 MKTRACK?	
Preset				
	Instrument preset	IP RESET	IP RESET	The device performs a PRESET. For default setting, see section "Model-Dependent Default Settings".
Printer				
	Hardcopy	PRINT ¹⁾	PRINT	
Program Flow				
	Stop previous function	ABORT ¹⁾	ABORT	Does not automatically set the command complete bit (bit 4) in the status byte. An additional DONE is required for that purpose.
Recall or Save				
	Recall analyzer state	RCLS	RCLS <numeric_value>	
	Save analyzer state	SAVES	SAVES <numeric_value>	
Span				
	Full Span	FS	FS	Full span value
	Frequency Span value	SP	SP <numeric_value> SP DN SP UP SP?	Default value Step size Formula for dependent values (resolution bandwidth, video bandwidth, sweep time)

¹⁾ HP8594E only

Function Category	Function	HP 8590 Command	Supported Command Subset	Known Differences
Sweep				
	Continuous Sweep Mode	CONTS	CONTS	
	Single Sweep	SNGLS	SNGLS	
	Gated Sweep On/Off	GATE ¹⁾	GATE ON OFF GATE 1 0	
	Gate Mode Edge/Level	GATECTL ¹⁾	GATECTL EDGE LEVEL GATECTL?	
	Gate delay	GD ¹⁾	GD <numeric_value> US MS SC GD DN GD UP GD?	
	Gate length	GL ¹⁾	GL <numeric_value> US MS SC GL DN GL UP GL?	
	Gate polarity	GP ¹⁾	GP POS NEG GP?	
	Sweep time value	ST	ST <numeric_value> US MS SC ST DN ST UP ST AUTO ST?	SWE:TIME Valid values Range Step size
Synchronization				
	Synchronization at the end of all previous commands	DONE	DONE DONE?	
	Start and complete a Full Sweep	TS	TS	Only available in single sweep mode
Trace				
	Trace Difference w. Display Line	AMBPL	AMBPL ON OFF AMBPL 1 0 AMBPL?	
	Trace Position (Display Line)	DL	DL <numeric_value> DB DM DL DN DL UP DL ON DL OFF DL?	The display line function is supported only in terms of trace position on the screen and video trigger level. The general display line function does not exist on the R&S ESCI. ON/OFF are accepted, but ignored; the line is automatically switched on/off with AMBPL ON/OFF. Its default position is different.
	Trace Blank	BLANK	BLANK TRA TRB TRC	

¹⁾ HP894E only

Function Category	Function	HP 8590 Command	Supported Command Subset	Known Differences
	Trace Copy	MOV	MOV TRA TRB TRC,TRA TRB TRC	
	Trace Clear/Write	CLRW	CLRW TRA TRB TRC	
	Detector Selection	DET	DET POS SMP NEG DET?	DET? returns SAMP instead of SMP on the R&S ESCI. DET not automatically set the command complete bit (bit 4) in the status byte. An additional DONE is required for that purpose.
	Trace Max Hold	MXMH	MXMH TRA TRB	
	Trace Min Hold	MINH ¹⁾	MINH TRC	
	Video Averaging	VAVG	VAVG TRA TRB TRC	
	Trace View	VIEW	VIEW TRA TRB TRC	
	Trace A Amplitude Values Query	TRA	TRA?	
	Trace B Amplitude Values Query	TRB	TRB?	
	Trace Data Format	TDF	TDF P TDF?	
Trigger				
	Trigger Mode	TM	TM FREE VID EXT TM?	
	Start New Sweep	TS	TS	

¹⁾ HP8594E only

Supported Commands of 8566A and 8568A Models

The command syntax is very different for models A and B. Different names are assigned to identical instrument functions, and the command structure likewise differs considerably between models A and models B.

The command structure for models A is as follows:

```
<command> ::=
<command code>[<SPC>][<data>|<step>][<SPC>][<delimiter>][<command code>]...<delimiter>
```

```
<data> ::=          <value>[<SPC>][<units code>][<SPC>][<delimiter>][<SPC>][<data>]...
<step> ::=          UP|DN
```

where

```
<command code> = see Table "Supported Commands"
<value> =       integer or floating-point numerical value
<units code> =   DM | -DM | DB | HZ | KZ | MZ | GZ | MV | UV | SC | MS | US
<delimiter> =   <CR> | <LF> | <,> | <;> | <ETX>
<SPC> =         3210
<ETX> =         310
```

Command sections given in [] are optional.

The R&S ESCI IEC/IEEE-bus hardware differs from that used in the HP analyzers. Therefore, the following constraint exists:

<LF>| <EOI> are still used as delimiters since the IEC/IEEE-bus hardware is able to identify them. The other delimiters are identified and evaluated during syntax analysis.

Supported Commands of Models 8566A and 8568A

8566A / 8568A Command	Supported Command Subset	Known Differences
A1		
A2		
A3		
A4		
AT	AT <numeric_value> DB AT DN AT UP AT?	INP:ATT AT DN/UP: Step size
B1		
B2		
B3		
B4		
C1		
C2		
CA		
CF	CF <numeric_value> HZ KHZ MHZ GHZ CF UP CF DN CF?	Default value Range of values Step size
CR		Default ratio span / RBW

8566A / 8568A Command	Supported Command Subset	Known Differences
CS		
CT		Calculation formula of coupled sweep time
CV		Default ratio span / RBW
DL	DL <numeric_value> DB DM DL DN DL UP DL?	
E1		
E2		
E3		
E4		
FA	FA <numeric_value> HZ KHZ MHZ GHZ FA UP FA DN FA?	Default value Range of values Step size
FB	FB <numeric_value> HZ KHZ MHZ GHZ FB UP FB DN FB?	Default value Range of values Step size
FS		
I1		The command is accepted without an error message being output, but it is ignored.
I2		The command is accepted without an error message being output, but it is ignored.
ID		Query of instrument type. The instrument type entered with <i>SETUP - GENERAL SETUP - GPIB - ID STRING USER</i> will be returned.
IP	The device performs a PRESET. For default setting ,see section "Model-Dependent Default Settings". <i>In the remote mode, the screen area for measurement display will be reduced. The LOCAL softkey (lowermost softkey) will be shifted slightly towards the center of the screen.</i>	
KS	KS= <numeric_value> HZ KHZ MHZ GHZ KS= DN KS= UP KS=?	
KSA		
KSB		
KSC		
KSD		
KSE	KSE <numeric_value> <char data>@	
KSG	KSG	

8566A / 8568A Command	Supported Command Subset	Known Differences
	KSG ON KSG <numeric_value>	
KSH		
KSK		
KSL		
KSM		
KSP	KSP <numeric_value>	
KST	The device performs a PRESET. For default setting, see section "Model-Dependent Default Settings".	This command calls a function identical to that of IP.
KSV	KSV <numeric_value> HZ KHZ MHZ GHZ KSV?	
KSW		
KSX		
KSY		
KSZ	KSZ <numeric_value> DB KSZ?	
KSa		
KSb		
KSd		
KSe		
KSj		
KSk		
KSl		
KSm		
LG		
LN		
M1		
M2	M2 M2 <numeric_value> HZ KHZ MHZ GHZ M2 DN M2 UP M2?	Default value Range of values Step size
M3	M3 M3 <numeric_value> HZ KHZ MHZ GHZ M3 DN M3 UP M3?	Default value Range of values Step size
M4	M4 <numeric_value> HZ KHZ MHZ GHZ	
MA		
MC0		
MC1		
MF		
MT0		

8566A / 8568A Command	Supported Command Subset	Known Differences
MT1		
O1		
O3		
OL?		Storage of instrument settings: 80 characters are returned as information on the instrument settings. The contents of the 80 characters returned does not correspond to the original data contents of the 8566A / 8568A family.
OL	OL <80 characters>	Readout of instrument settings: The 80 characters read by means of OL? are accepted as information on the corresponding instrument settings. The contents of the 80 characters read does not correspond to the original data contents of the 8566A / 8568A family.
OT		Readout of screen contents. Start and stop frequencies are always output as frequencies.
PP		The command is accepted without an error message being output, but it is ignored.
R1		Activates the command error bit.
R2		Activates Command Error End of Sweep.
R3		Activates Command Error Device Error.
R4		Activates Command Error Units Key Pressed. The bit patterns of commands R2, R3, R4 are ORed if the commands are called consecutively.
RB	RB <numeric_value> HZ KHZ MHZ GHZ RB DN RB UP RB?	Default value Range of values Step size
RC	<1 2... 6>	Loads Save Set 1 to 6.
S1		
S2		
SP	SP <numeric_value> HZ KHZ MHZ GHZ SP DN SP UP SP?	Default value Range of values Step size
SS	SS <numeric_value> HZ KHZ MHZ GHZ SS DN	Default value

8566A / 8568A Command	Supported Command Subset	Known Differences
	SS UP SS?	Range of values Step size
ST	ST <numeric_value> US MS SC ST DN ST UP ST?	Default value Range of values Step size
SV	<1 2... 6>	Stores Save Set 1 to 6.
T0		
T1		
T3		
T4		
TA		Output of 1001 trace points of trace A in O1 or O3 format.
TB		Output of 1001 trace points of trace B in O1 or O3 format.
TH	TH <numeric_value> DB DM TH DN TH UP TH?	
TS		
VB	VB <numeric_value> HZ KHZ MHZ GHZ VB DN VB UP VB?	

Model-Dependent Default Settings

When the IEC/IEEE-bus language is switched over to an 85xx model, the IEC/IEEE-bus address will automatically be switched over to 18 provided that the default address of the R&S ESCI (20) is still set. If a different value is set, this value will be maintained. Upon return to SCPI, this address will remain unchanged.

The following table shows the default settings obtained after switchover of the IEC/IEEE-bus language and for the commands IP, KST and RESET:

Model	# of Trace Points	Start Freq.	Stop Freq.	Ref Level	Input Coupling
8566A/B	1001	2 GHz	22 GHz	0 dBm	DC (ESCI) AC (ESPI)
8568A/B	1001	0 Hz	1.5 GHz	0 dBm	AC
8560E	601	0 Hz	2.9 GHz	0 dBm	AC
8561E	601	0 Hz	6.5 GHz	0 dBm	AC
8562E	601	0 Hz	13.2 GHz	0 dBm	AC
8563E	601	0 Hz	26.5 GHz	0 dBm	AC
8564E	601	0 Hz	40 GHz	0 dBm	AC
8565E	601	0 Hz	50 GHz	0 dBm	AC
8594E	401	0 Hz	3 GHz	0 dBm	AC

Note regarding the set stop frequency:

The stop frequency given in the table may be limited to the corresponding frequency range of the R&S ESCI.

Note regarding the number of test points (trace points):

The # of trace points is switched over only upon transition to the REMOTE state.

Data Output Formats

In the case of the SCPI and IEEE488.2 standards, the output formats for numerical data are flexible to a large extent. The output format for the HP units, by contrast, is accurately defined with respect to the number of digits. The memory areas for reading instrument data have therefore been adapted accordingly in the remote-control programs for instruments of this series.

Therefore, in response to a query, the R&S ESCI returns data of the same structure as that used by the original instruments; this applies in particular to the number of characters returned.

Two formats are currently supported when trace data is output: Display Units (command O1) and physical values (command O3 or TDF P). As to the "Display Units" format, the level data of the R&S ESCI is converted to match the value range and the resolution of the 8566/8568 series. Upon switchover to the *REMOTE* state, the R&S ESCI is reconfigured such that the number of test points (trace points) corresponds to that of the 85xx families (1001 for 8566A/B and 8568A/B, 601 for 8560E to 8565E, 401 for 8594E).

Bei eingeschaltetem Display wird dabei die Größe des Diagrammbereichs gegenüber der Normaldarstellung reduziert; beim Übergang auf *LOCAL* wird zur normalen Diagrammgröße zurückgekehrt.

IEC/IEEE-Bus Status Reporting

The assignment of status bits by commands R1, R2, R3, R4, RQS is supported. The STB command and the serial poll respond with an 8-bit value having the following assignment:

The return value of a serial poll is to use the STB command in order to identify the reason for the service request. The bits returned by the STB command are mapped in the same way as for the RQS command.

Bit enabled by RQS
1 (Units key pressed)
2 (End of Sweep)
3 (Device Error)
4 (Command Complete)
5 (Illegal Command)
6 (Service Request)

Bits 0 and 7 are not used and always have the value 0.

It should be noted that the R&S ESCI will report any key pressed on the front panel (if bit 1 was enabled) rather than only the unit keys.

Additionally there is a difference in the handling of bit 6. This bit reflects the status of the SRQ line of the GPIB bus on the HP 8590 analyzers. With the R&S ESCI this is not possible. Therefore this bit will be set as soon as any of the bits 1 to 5 is set, but it will not be cleared on a serial poll.

Contents - Chapter 7 "Remote Control - Programming Examples"

7 Remote Control - Programming Examples	7.1
Basic Steps of IEC/IEEE-Bus Programming	7.1
Including IEC-Bus Library for VisualBasic	7.1
Initialization and Default Status	7.2
Creating Global Variables	7.2
Initiate Controller	7.2
Initiate Instrument	7.3
Switching the Display On/Off	7.3
Configuring Power Save Function (Display Permanently Switched Off)	7.4
Transmission of Simple Instrument Setting Commands	7.4
Return to Manual Control	7.4
Reading Out Instrument Settings	7.5
Positioning Markers and Displaying Values	7.5
Command Synchronization	7.6
Service Request	7.7
Initiate Service Request	7.7
Waiting for the Arrival of a Service Request	7.8
Waiting Without Blocking the Keyboard and Mouse	7.9
Service Request Routine	7.10
Reading Out the Output Buffer	7.10
Reading Out Error Messages	7.11
Evaluation of SCPI Status Registers	7.11
Evaluation of Event Status Register	7.12
More Complex Programming Examples	7.13
Default Setting of the FSP	7.13
Setting the IEC/IEEE Bus Status Register	7.13
Default Setting for Measurements	7.14
Using Marker and Delta Marker	7.15
Marker Search Functions, Limitation of Search Range	7.15
Measuring Spurious Emissions	7.17
Frequency Counting	7.18
Operation with Fixed Reference Point (Reference Fixed)	7.19
Phase and Phase Noise Measurement	7.20
Shape Factor Measurement (using n dB down)	7.21
Measuring the Third Order Intercept Point	7.22
Measuring the AM Modulation Depth	7.23
Limit Lines and Limit Test	7.24
Measuring the Channel and Adjacent Channel Power	7.26
Occupied Bandwidth Measurement	7.28
Time Domain Power Measurement	7.29
Fast Power Measurement on Power Ramps	7.30
Power Measurement with Multi-Summary Marker	7.30
Multi-Burst Power Measurement	7.32
Fast Level Measurement Using Frequency Lists	7.34
Level Correction of Transducers (Definition of Transducer Factors)	7.36
Reading Trace Data	7.37

Measuring the Magnitude and Phase of a Signal (I/Q Data Acquisition)	7.39
Averaging I/Q Data	7.42
Storing and Loading Device Settings	7.43
Storing Instrument Settings.....	7.43
Loading Device Settings	7.44
Setting the Data Set for Startup Recall	7.44
Reading and Writing Files	7.45
Reading a File from the Instrument.....	7.45
Creating a File on the Instrument.....	7.46
Configuring and Starting a Printout	7.47

7 Remote Control - Programming Examples

The following programming examples have a hierarchical structure, i.e. subsequent examples are based on previous ones. It is thus possible to compile very easily an operational program from the modules of the given examples.

Basic Steps of IEC/IEEE-Bus Programming

The examples explain the programming of the instrument and can serve as a basis to solve more complex programming tasks.

VISUAL BASIC has been used as programming language. However, the programs can be translated into other languages.

Including IEC-Bus Library for VisualBasic

Programming hints:

- **Output of texts using the "Print" function**

The following programming examples are based on the assumption that all subroutines are part of a form (file extension: .FRM). In this case the syntax

```
Print "Text"
```

is allowed.

If however the subroutines are stored as a so-called module (file extension: .BAS), the print instruction should be preceded by the name of a form which has the required print method. If, for example, there is a form with the name "Main", the associated print instruction is as follows:

```
Main.Print "Text".
```

- **Access to functions of GPIB.DLL**

To create Visual Basic control applications, the file GPIB.BAS (as from VB 6.0 VBIB-32.BAS) is added to a project so that the functions of the RSIB.DLL can be called. In addition, the file NIGLOBAL.BAS is added to the project. This file contains constants and definitions for the processing of errors, timeout values, etc.

- **Declaration of DLL functions as procedures**

Since the functions all return an integer value, the functions in the file GPIB.BAS are all declared as follows:

```
Declare Function xxx Lib "gplib.dll" ( ... ) As Integer
```

The function value with the status variables `ibsta` should be allocated a variable when it is called up. Since this value is also returned via a reference parameter of the functions, the functions can be declared as procedures as follows:

```
Declare Sub xxx Lib "rsib.dll" ( ... )
```

- **Generating a response buffer**

Since the DLL returns zero-terminated strings in case of responses, a string of sufficient length should be generated prior to calling the functions `ibrd()` and `ilrd()`, since Visual Basic prefixes a length value to the strings which is not updated by the DLL.

The following two possibilities are available to generate a length value for a string:

```
- Dim Rd as String * 100
- Dim Rd as String
  Rd = Space$(100)
```

Initialization and Default Status

Variables used by all subroutines should be stored at the beginning of every program.

Then the IEC/IEEE bus as well as the settings of the instrument are brought into a defined default status at the beginning of every program. Subroutines "InitController" and "InitDevice" are used to this effect.

Creating Global Variables

Global variables are placed in so-called "modules" (file extension: .BAS) in Visual Basic. Therefore, at least one module (e.g. "GLOBALS.BAS) should be created which contains the variables used by all subroutines, such as the device addresses used by the IEC/IEEE-bus driver.

The file should contain the following instructions for the programming examples below:

```
Global receiver As Integer
Global boardId As Integer
```

Initiate Controller

```
REM ----- Initiate controller -----
Public SUB InitController()

ieaddress% = 20                                'IEC/IEEE-bus address of the
                                              'instrument

CALL IBFIND("GPIB0", boardId%)                'Open port to the controller
CALL IBFIND("DEV1", receiver%)                'Open port to the instrument
CALL IBPAD(receiver%, ieaddress%)             'Inform controller on instrument
                                              'address

CALL IBTMO(receiver%, 11)                     'Response time to 1 sec

END SUB
REM *****
```

Initiate Instrument

The IEC-bus status registers and instrument settings of the instrument are brought to the default status.

```

REM ----- Initiate instrument -----
Public SUB InitDevice()

CALL IBWRT(receiver%, "*CLS")           'Reset status registers
CALL IBWRT(receiver%, "*RST")         'Reset instrument

END SUB
REM*****

```

Switching the Display On/Off

In the default status, all remote control commands are executed with the display switched off to achieve maximum measurement speed. During the generation of remote control programs, however, the display is often needed to check the settings programmed as well as the test results.

The functions shown below are examples of how the display can be switched on or off by remote control::

```

REM ----- Switch display on -----
Public SUB DisplayOn()
CALL IBWRT(receiver%, "SYST:DISP:UPD ON")   'Switch display on
END SUB
REM*****

REM ----- Switch display off -----
Public SUB DisplayOff()
CALL IBWRT(receiver%, "SYST:DISP:UPD OFF")  'Switch display off
END SUB
REM*****

```

Configuring Power Save Function (Display Permanently Switched Off)

The results on the screen are often not required during IEC/IEEE-bus operation. Although the command "SYSTEM:DISPLAY:UPDATE OFF" switches off the display of results, which brings considerable advantages in terms of speed in the remote control mode, the display itself and in particular the backlighting remain switched on.

To switch the display off use the power save function, the response time having to be set in minutes prior to activation.

Note: *The display is switched on as soon as a key is pressed on the instrument front panel.*

```
REM ----- Configure power save function -----
Public SUB PowerSave()

CALL IBWRT(receiver%, "SYSTEM:PSAVE:HOLDoff 1") 'Set holdoff to 1 minute
CALL IBWRT(receiver%, "SYSTEM:PSAVE ON")        'Power save function on
END SUB
REM*****
```

Transmission of Simple Instrument Setting Commands

Center frequency, span, and reference level of the instrument are set in this example.

```
REM ----- Instrument setting commands -----
PUBLIC SUB SimpleSettings()

CALL IBWRT(receiver%, "FREQUENCY:CENTER 128MHZ") 'Center frequency 128 MHz
CALL IBWRT(receiver%, "FREQUENCY:SPAN 10MHZ")    'Span 10 MHz
CALL IBWRT(receiver%, "DISPLAY:TRACE:Y:RLEVEL -10dBm")
                                                    'Reference level -10dBm
END SUB
REM*****
```

Return to Manual Control

```
REM ----- Switch instrument over to manual control -----
CALL IBLOC(receiver%) 'Set instrument to Local state
REM*****
```

Reading Out Instrument Settings

The settings made in the above example are read out using the abbreviated commands.

```

REM ----- Reading out instrument settings -----
PUBLIC SUB ReadSettings()

CFfrequency$ = SPACE$(20)           'Provide text variables (20 characters)
CALL IBWRT(receiver%, "FREQ:CENT?") 'Request center frequency
CALL IBRD(receiver%, CFfrequency$)  'Read value

CFspan$ = SPACE$(20)                'Provide text variables (20 characters)
CALL IBWRT(receiver%, "FREQ:SPAN?") 'Query span
CALL IBRD(receiver%, CFspan$)       'Read value

RLevel$ = SPACE$(20)                'Provide text variables (20 characters)
CALL IBWRT(receiver%, "DISP:TRAC:Y:RLEV?")
                                     'Query reference level
CALL IBRD(receiver%, RLevel$)       'Read value

REM ----- Display values on the screen -----
PRINT "Center frequency: "; CFfrequency$,
PRINT "Span:           "; CFspan$,
PRINT "Reference level: "; RLevel$,
REM *****

```

Positioning Markers and Displaying Values

```

REM ----- Examples of marker functions -----
PUBLIC SUB ReadMarker()

CALL IBWRT(receiver%, "CALC:MARKER ON;MARKER:MAX")
                                     'Activate marker1 and start peak search
MKmark$ = SPACE$(30)                'Provide text variables (30 characters)
CALL IBWRT(receiver%, "CALC:MARK:X?;Y?") 'Query frequency and level
CALL IBRD(receiver%, MKmark$)        'Read value

REM ----- Display values on the screen -----
PRINT "Center frequency / level "; MKmark$,
REM *****

```

Command Synchronization

The possibilities for synchronization implemented in the following example are described in Chapter 5, Section "Command Order and Command Synchronization".

```

REM ----- Examples of command synchronization -----
PUBLIC SUB SweepSync()

REM The command INITiate[:IMMediate] starts a single sweep if the command
REM INIT:CONT OFF was previously sent. It has to be ensured that the next
REM command is only executed when the entire sweep is complete.

CALL IBWRT(receiver%, "INIT:CONT OFF")

REM ----- First possibility: Use of *WAI -----
CALL IBWRT(receiver%, "ABOR;INIT:IMM; *WAI")

REM ----- Second possibility: Use of *OPC? -----
OpcOk$ = SPACE$(2)           'Space for *OPC? - Provide response
CALL IBWRT(receiver%, "ABOR;INIT:IMM; *OPC?")

REM ----- The controller can operate other instruments -----
CALL IBRD(receiver%, OpcOk$)           'Wait for "1" from *OPC?

REM ----- Third possibility: Use of *OPC -----
REM In order to be able to use the service request function in conjunction
REM with a National Instruments GPIB driver, the setting "Disable
REM Auto Serial Poll" must be changed to "yes" by means of IBCONF!
CALL IBWRT(receiver%, "*SRE 32")      'Permit service request for ESR
CALL IBWRT(receiver%, "*ESE 1")      'Set event enable bit for
                                     'operation complete bit
CALL IBWRT(receiver%, "ABOR;INIT:IMM; *OPC") 'Start sweep and
                                     'synchronize to OPC
CALL WaitSRQ(boardID%,result%)      'Wait for service request
REM Continue main program.

END SUB
REM *****

```

Service Request

The service request routine requires an extended initialization of the instrument in which the relevant bits of the transition and enable registers are set.

In order to use the service request function in conjunction with a National Instruments GPIB driver, the setting "Disable Auto Serial Poll" must be changed to "yes" by means of IBCONF.

Initiate Service Request

REM ---- Example of initialization of the SRQ in the case of errors -----

PUBLIC SUB SetupSRQ()

```
CALL IBWRT(receiver%, "*CLS")           'Reset status reporting system
CALL IBWRT(receiver%, "*SRE 168")       'Permit service request for
                                         'STAT:OPER,STAT:QUES and ESR
                                         'register
CALL IBWRT(receiver%, "*ESE 60")        'Set event enable bit for
                                         'command, execution, device-
                                         'dependent and query error
CALL IBWRT(receiver%, "STAT:OPER:ENAB 32767") 'Set OPERation enable bit for
                                         'all events
CALL IBWRT(receiver%, "STAT:OPER:PTR 32767") 'Set appropriate OPERation
                                         'Ptransition bits
CALL IBWRT(receiver%, "STAT:QUES:ENAB 32767") 'Set questionable enable bits
                                         'for all events
CALL IBWRT(receiver%, "STAT:QUES:PTR 32767") 'Set appropriate questionable
                                         'Ptransition bits
```

END SUB

REM *****

Waiting for the Arrival of a Service Request

There are basically two methods of waiting for the arrival of a service request:

1. Blocking (user inputs not possible):

This method is appropriate if the waiting time until the event to be signalled by an SRQ is short (shorter than the selected timeout), if no response to user inputs is required during the waiting time, and if – as the main criterion – the event is absolutely certain to occur.

Reason:

From the time the WaitSRQ() function is called until the occurrence of the expected event, it does not allow the program to respond to mouse clicks or key entries during the waiting time. Moreover, it causes program abort if the SRQ event does not occur within the predefined timeout period. The method is, therefore, in many cases not suitable for waiting for measurement results, especially with triggered measurements.

The following function calls are required:

```
CALL WaitSRQ(boardID%,result%)      'Wait for service request
                                     'User inputs are not possible
                                     'during the waiting time!

IF (result% = 1) THEN CALL Srq        'If SRQ is recognized =>
                                     'subroutine for evaluation
```

2. Non-blocking (user inputs possible):

This method is recommended if the waiting time until the event to be signalled by an SRQ is long (longer than the selected timeout), and user inputs should be possible during the waiting time, or if the event is not certain to occur. This method is, therefore, the preferable choice for waiting for the end of measurements, i.e. the output of results, especially in the case of triggered measurements.

The method necessitates a waiting loop that checks the status of the SRQ line at regular intervals and returns control to the operating system during the time the expected event has not yet occurred. In this way, the system can respond to user inputs (mouse clicks, key entries) during the waiting time.

It is advisable to employ the Hold() auxiliary function, which returns control to the operating system for a selectable waiting time (see section "Waiting Without Blocking the Keyboard or Mouse"), so enabling user inputs during the waiting time.

```
result% = 0

For i = 1 To 10                       'Abort after max. 10 loop
                                     'iterations

  CALL TestSRQ(boardID%,result%)      'Check service request line

  If (result% <> 0) Then
    CALL Srq                           'If SRQ is recognized =>
                                       'subroutine for evaluation
  Else
    Call Hold(20)                       'Call hold function with
                                       '20 ms waiting time.
                                       'User inputs are possible.
  Endif

Next i

If result% = 0 Then
  PRINT "Timeout Error; Program aborted" ' Output error message
  STOP                                  'Stop software
Endif
```

Waiting Without Blocking the Keyboard and Mouse

A frequent problem with remote control programs using Visual Basic is to insert waiting times without blocking the keyboard and the mouse.

If the program is to respond to user inputs also during a waiting time, control over the program events during this time must be returned to the operating system. In Visual Basic, this is done by calling the *DoEvents* function. This function causes keyboard- or mouse-triggered events to be executed by the associated elements. For example, it allows the operation of buttons and input fields while the user waits for an instrument setting to be completed.

The following programming example describes the *Hold()* function, which returns control to the operating system for the period of the waiting time selectable in milliseconds.

```

Rem *****
Rem The waiting function below expects the transfer of the desired
Rem waiting time in milliseconds. The keyboard and the mouse remain
Rem operative during the waiting period, thus allowing desired elements
Rem to be controlled
Rem *****
Public Sub Hold(delayTime As Single)
    Start = Timer          'Save timer count on calling the function
    Do While Timer < Start + delayTime / 1000    'Check timer count
        DoEvents          'Return control to operating system
                        'to enable control of desired elements as long as
                        'timer has not elapsed
    Loop
End Sub
Rem *****

```

The waiting procedure is activated simply by calling *Hold(<Waiting time in milliseconds>)*.

Service Request Routine

A service request is processed in the service request routine.

Note: the variables userN% and userM% must be pre-assigned usefully!

```

REM ----- Service request routine -----
Public SUB Srq()

ON ERROR GOTO noDevice           'No user existing
CALL IBRSP(receiver%, STB%)     'Serial poll, read status byte
IF STB% > 0 THEN                 'This instrument has bits set
                                'in the STB

    SRQFOUND% = 1
    IF (STB% AND 16) > 0 THEN CALL Outputqueue
    IF (STB% AND 4) > 0 THEN CALL ErrorQueueHandler
    IF (STB% AND 8) > 0 THEN CALL Questionablestatus
    IF (STB% AND 128) > 0 THEN CALL Operationstatus
    IF (STB% AND 32) > 0 THEN CALL Esrread
END IF

noDevice:
END SUB                         'End of SRQ routine

```

```

REM *****
Reading out the status event registers, the output buffer and the error/event queue is effected in
subroutines.

```

Reading Out the Output Buffer

```

REM ----- Subroutine for the individual STB bits -----
Public SUB Outputqueue()         'Reading the output buffer

result$ = SPACE$(100)           'Make space for response
CALL IBRD(receiver%, result$)
PRINT "Contents of Output Queue : "; result$
END SUB

REM *****

```

Reading Out Error Messages

```

REM ----- Subroutine for reading the error queue -----
Public SUB ErrorQueueHandler()
ERROR$ = SPACE$(100)           'Make space for error variable
CALL IBWRT(receiver%, "SYSTEM:ERROR?")
CALL IBRD(receiver%, ERROR$)
PRINT "Error Description : "; ERROR$
END SUB
REM *****

```

Evaluation of SCPI Status Registers

```

REM ----- Subroutine for evaluating Questionable Status Register -----
Public SUB Questionablestatus()
Ques$ = SPACE$(20)             'Preallocate blanks to text variable
CALL IBWRT(receiver%, "STATUS:QUESTIONABLE:EVENT?")
CALL IBRD(receiver%, Ques$)
PRINT "Questionable Status: "; Ques$
END SUB
REM *****

```

```

REM ----- Subroutine for evaluating Operation Status Register -----
Public SUB Operationstatus()
Oper$ = SPACE$(20)             'Preallocate blanks to text variable
CALL IBWRT(receiver%, "STATUS:OPERATION:EVENT?")
CALL IBRD(receiver%, Oper$)
PRINT "Operation Status: "; Oper$
END SUB
REM *****

```

Evaluation of Event Status Register

```
REM ----- Subroutine for evaluating the Event Status Register -----
Public SUB Esrread()
Esr$ = SPACE$(20)           'Preallocate blanks to text variable
CALL IBWRT(receiver%, "*ESR?")           'Read ESR
CALL IBRD(receiver%, Esr$)
IF (VAL(Esr$) AND 1) > 0 THEN PRINT "Operation complete"
IF (VAL(Esr$) AND 2) > 0 THEN PRINT "Request Control"
IF (VAL(Esr$) AND 4) > 0 THEN PRINT "Query Error"
IF (VAL(Esr$) AND 8) > 0 THEN PRINT "Device dependent error"
IF (VAL(Esr$) AND 16) > 0 THEN
    PRINT "Execution Error; Program aborted" ' Output error message
    STOP                                     'Stop software
    END IF
IF (VAL(Esr$) AND 32) > 0 THEN
    PRINT "Command Error; Program aborted" ' Output error message
    STOP                                     'Stop software
    END IF
IF (VAL(Esr$) AND 64) > 0 THEN PRINT "User request"
IF (VAL(Esr$) AND 128) > 0 THEN PRINT "Power on"
END SUB
REM *****
```

More Complex Programming Examples

Default Setting of the R&S ESCI

The following settings are an example of how to modify the default setting of the R&S ESCI. It should be noted that only some settings are necessary depending on the example of application. In particular, the settings for resolution bandwidth, video bandwidth and sweep time are often not needed since these parameters are automatically calculated in the default setting on modifying the frequency range (span). The insertion loss is also automatically calculated depending on the reference level. The level detectors are coupled to the selected trace mode in the default setting. The settings which are automatically calculated in the default setting are marked by (*) in the following programming example.

Setting the IEC/IEEE Bus Status Register

```

REM *****
Public Sub SetupStatusReg()

'----- IEEE 488.2 status register -----
CALL IBWRT(receiver%,"*CLS")           'Reset Status Registers
CALL IBWRT(receiver%,"*SRE 168")       'Enable service request
                                        'for STAT:OPER-,STAT:QUES- and
                                        'ESR registers
CALL IBWRT(receiver%,"*ESE 61")        'Set Event Enable bit for:
                                        'Operation Complete
                                        'Command-, Execution-,Device
                                        'Dependent- and Query Error

'----- SCPI status register -----
CALL IBWRT(receiver%,"STAT:OPER:ENAB 0") 'Disable OPERation Status Reg
CALL IBWRT(receiver%,"STAT:QUES:ENAB 0") 'Disable Questionable Status
                                        'Register

End Sub
REM *****

```

Default Setting for Measurements

```

REM *****
Public Sub SetupInstrument()

'----- R&S ESCI default setting -----
-----
CALL SetupStatusReg           'Set status registers
CALL IBWRT(receiver%,"*RST") 'Reset instrument
CALL IBWRT(receiver%,"SYST:DISP:UPD ON") 'ON: display on
                                      'OFF: off(improved
                                      '      performance)

CALL IBWRT(receiver%,"DISP:FORM SINGLE") 'Full screen
CALL IBWRT(receiver%,"DISP:WIND1:SEL")  'Active screen A
CALL IBWRT(receiver%,"INIT:CONT OFF")    'Single sweep

'----- Set frequency -----
CALL IBWRT(receiver%,"FREQUENCY:CENTER 100MHz") 'Center frequency
CALL IBWRT(receiver%,"FREQ:SPAN 1 MHz")        'Span

'----- Set level -----
CALL IBWRT(receiver%,"DISP:WIND:TRAC:Y:RLEV -20dBm") 'Reference level
CALL IBWRT(receiver%,"INP:ATT 10dB")                'Input attenuation (*)

'----- Scale y axis -----
CALL IBWRT(receiver%,"DISP:WIND:TRAC:Y:SPAC LOG")    'Log level axis
CALL IBWRT(receiver%,"DISP:WIND:TRAC:Y:SCAL 100dB") 'Level range
CALL IBWRT(receiver%,"DISP:WIND:TRAC:Y:SCAL:MODE ABS") 'Absolute scaling
CALL IBWRT(receiver%,"CALC:UNIT:POW DBM")           'Unit of y axis

'----- Trace and detector settings -----
CALL IBWRT(receiver%,"DISP:WIND:TRAC1:MODE AVER")    'Trace1 average
CALL IBWRT(receiver%,"AVER:TYPE VID")               'Average mode video;
                                      '"LIN" for linear

CALL IBWRT(receiver%,"SWE:COUN 10")                 'Sweep count
CALL IBWRT(receiver%,"DISP:WIND:TRAC2:STAT OFF")    'Trace2 blank
CALL IBWRT(receiver%,"DISP:WIND:TRAC3:STAT OFF")    'Trace3 blank
CALL IBWRT(receiver%,"CALC:MATH:STAT OFF")          'Trace mathematics off

CALL IBWRT(receiver%,"DETECTOR1 RMS")               'Detector Trace1  (*)
CALL IBWRT(receiver%,"DET2:AUTO ON")                'Detector Trace2  (*)
CALL IBWRT(receiver%,"DET3:AUTO ON")                'Detector Trace3  (*)

'----- Band width and sweep time -----
CALL IBWRT(receiver%,"BAND:RES 100KHz")             'Resolution BW (*)
CALL IBWRT(receiver%,"BAND:VID 1MHz")               'Video bandwidth  (*)
CALL IBWRT(receiver%,"SWE:TIM 100ms")               'Sweep time        (*)

END SUB
REM *****

```

Using Marker and Delta Marker

Marker Search Functions, Limitation of Search Range

The example below is based on an AM-modulated signal at 100 MHz with the following characteristics:

- Carrier signal level: -30 dBm
- AF frequency: 100 kHz
- Modulation depth: 50 %

Marker 1 and delta marker 2 are set one after the other to the highest maxima of the measurement curve and then the frequency and level are read out. The default setting of the R&S ESCI can be used for the following measurements (SetupInstrument).

```

REM *****
Public Sub MarkerSearch()

result$ = Space$(100)
CALL SetupInstrument           'Default setting
'----- Peak search without search limit -----
CALL IBWRT(receiver%,"INIT:CONT OFF")           'Switch to single sweep
CALL IBWRT(receiver%,"CALC:MARK:PEXC 6DB")      'Define peak excursion
CALL IBWRT(receiver%,"CALC:MARK:STAT ON")       'Switch on Marker 1
CALL IBWRT(receiver%,"CALC:MARK:TRAC 1")        'Assign Marker 1 to Trace 1
CALL IBWRT(receiver%,"INIT;*WAI")              'Perform sweep with sync
CALL IBWRT(receiver%,"CALC:MARK:MAX;X?;Y?")     'Marker to peak; read out
CALL IBRD(receiver%, result$)                  'frequency and level
Print "Marker 1: ";result$

CALL IBWRT(receiver%,"CALC:DELT2:STAT ON;MAX;MAX:LEFT")
                                                    'Switch on delta marker 2
                                                    'Peak and then Next Peak Left

CALL IBWRT(receiver%,"CALC:DELT:MODE ABS")      'Delta marker2 frequency output
                                                    'absolute

CALL IBWRT(receiver%,"CALC:DELT2:X?;Y?")       'Delta marker 2 - read out
                                                    'frequency and level

CALL IBRD(receiver%, result$)

Print "Delta 2: ";result$

'----- Peak search with search limit in x direction -----
CALL IBWRT(receiver%,"CALC:MARK:X:SLIM:STAT ON;LEFT 0Hz;RIGHT 100.05MHz")
                                                    'Search limit on and set below
                                                    'LF on the right side

CALL IBWRT(receiver%,"CALC:DELT3:STAT ON;MAX;MAX:RIGHT")
                                                    'Delta marker 3 on
                                                    'Peak and then Next Peak Right
CALL IBWRT(receiver%,"CALC:DELT3:X?;Y?")       'Delta marker 3; Read out
                                                    'frequency and level, both must
                                                    'have the value 0

CALL IBRD(receiver%, result$)

Print "Delta 3: ";result$

```

```
'----- Peak search with search limit in y direction -----
CALL IBWRT(analyzer%,"CALC:THR:STAT ON")
CALL IBWRT(receiver%,"CALC:THR -35DBM")           'Threshold on and set above LF
CALL IBWRT(receiver%,"CALC:DELT3:STAT ON;MAX;MAX:NEXT")
                                           'Delta marker 3 on
                                           'Peak and then Next Peak
                                           ' => is not found

CALL IBWRT(receiver%,"CALC:DELT3:X:REL?::CALC:DELT3:Y?")
CALL IBRD(receiver%, result$)                 'Delta marker 3; read out
                                           'frequency and level, both must
                                           'have the value 0

Print "Delta 3: ";result$

'---- Set center frequency and reference level by means of markers -----
CALL IBWRT(receiver%,"CALC:MARK2:FUNC:CENT") 'Delta marker 2 -> Marker and
                                           'center frequency = Marker 2

CALL IBWRT(receiver%,"CALC:MARK2:FUNC:REF") 'Ref level = Marker 2
Call ibwrt(receiver%,"INIT;*WAI")           'Perform sweep with sync
END SUB
REM *****
```

Measuring Spurious Emissions

In transmission measurements, it is often necessary to search a large frequency range for unwanted spurious emissions.

This can be done by means of the R&S ESCI's LIST PEAKS function, which finds up to 50 peaks in a preselected frequency range and outputs them as a list. The search range can be defined both in terms of frequency and level, and the number of peaks to be found is selectable as well.

In the following example, the 10 highest peaks are to be found in a preselected frequency range. Only signals >-60 dBm in a range ± 400 kHz about the center frequency are of interest, so the search range is limited accordingly. The signals found are output in the order of ascending frequency.

```

REM *****
Public Sub SpuriousSearch()

powerlist$ = Space$(1000)
frequlist$ = Space$(1000)
count$ = Space$(30)

'----- R&S ESCI default setting -----
CALL SetupInstrument           'Default setting
CALL IBWRT(receiver%,"INIT:CONT OFF")  'Default setting

'----- Definition of search range -----
CALL IBWRT(receiver%,"CALC:MARK:X:SLIM:STAT ON")
CALL IBWRT(analyzer%,"CALC:MARK:X:SLIM:LEFT 99.6MHz;RIGHT 100.4MHz")
                                     'Activate search limit and
                                     'set to  $\pm 400$  kHz about
                                     'center frequency

CALL IBWRT(analyzer%,"CALC:THR:STAT ON")
CALL IBWRT(receiver%,"CALC:THR -60DBM")  'Activate threshold and
                                     'set to -60 dBm

'----- Activate search for spurious -----
CALL IBWRT(receiver%,"CALC:MARK:FUNC:FPE:SORT X")  'Sort according to
                                     'frequency
CALL IBWRT(receiver%,"INIT;*WAI")  'Perform sweep with sync
CALL IBWRT(receiver%,"CALC:MARK:FUNC:FPE 10")  'Search for
                                     '10 highest peaks
CALL IBWRT(receiver%,"CALC:MARK:FUNC:FPE:COUN?")  'Call number of
                                     'peaks, check it,
CALL IBRD(receiver%, count$)  'and read it in
CALL IBWRT(receiver%,"CALC:MARK:FUNC:FPE:X?")  'Query and read
CALL IBRD(receiver%, frequlist$)  'frequency list
CALL IBWRT(receiver%,"CALC:MARK:FUNC:FPE:Y?")  'Query and read
CALL IBRD(receiver%, powerlist$)  'level list
Print "# of spurious: ";count$  'Output number of results
Print "Frequencies: ";frequlist$  'Output frequency list
Print "Power: ";powerlist$  'Output level list

END SUB
REM *****

```

Frequency Counting

The following example is based on a signal with a level of -30 dBm at 100 MHz. The default setting of the R&S ESCI can also be used for this measurement (SetupInstrument). The objective of frequency counting is to determine the exact frequency of the signal at 100 MHz.

```

REM *****
Public Sub MarkerCount()

result$ = Space$(100)
CALL SetupInstrument           'Default setting
'----- Measure signal frequency with frequency counter -----
CALL IBWRT(receiver%,"INIT:CONT OFF")           'Single sweep on
CALL IBWRT(receiver%,"CALC:MARK:PEXC 6DB")      'Peak excursion
CALL IBWRT(receiver%,"CALC:MARK:STAT ON")       'Marker 1 on
CALL IBWRT(receiver%,"CALC:MARK:TRAC 1")        'Assign marker 1 to trace 1
CALL IBWRT(receiver%,"CALC:MARK:X 100MHZ")      'Set marker 1 to 100 MHz
CALL IBWRT(receiver%,"CALC:MARK:COUNT:RES 1HZ") 'Frequency counter 1 Hz
CALL IBWRT(receiver%,"CALC:MARK:COUNT ON")     'frequency counter on
CALL IBWRT(receiver%,"INIT;*WAI")              'Perform sweep with sync
CALL IBWRT(receiver%,"CALC:MARK:COUNT:FREQ?")  'Query measured frequency
CALL IBRD(receiver%, result$)                  'and read it out

Print "Marker Count Freq: ";result$

END SUB
REM *****

```

Operation with Fixed Reference Point (Reference Fixed)

The following example is based on a signal with a level of -20 dBm at 100 MHz. The harmonics of the signal lie at 200 MHz, 300 MHz, etc. In the presence of high-quality signal sources these harmonics may be outside the dynamic range of the R&S ESCI. In order to measure harmonic suppression, however, the level must be set to higher sensitivity for measuring the harmonics; the carrier has to be suppressed by a notch filter to avoid overloading the R&S ESCI RF input.

In the following example, two measurements are therefore performed with different level settings, first with a high reference level at the carrier frequency and then with a low reference level at the frequency of the 3rd harmonic.

The default setting of the R&S ESCI for measurements (SetupInstrument) is used as starting point and adaptations are then made for the measurement.

```

REM *****
Public Sub RefFixed()

result$ = Space$(100)
CALL SetupInstrument           'Default setting

'----- Measure the reference point -----
CALL IBWRT(receiver%,"INIT:CONT OFF")           'Single sweep
CALL IBWRT(receiver%,"CALC:MARK:PEXC 6DB")      'Peak Excursion
CALL IBWRT(receiver%,"CALC:MARK:STAT ON")       'Marker1 on
CALL IBWRT(receiver%,"CALC:MARK:TRAC 1")        'Assign Marker 1 to Trace 1
CALL IBWRT(receiver%,"INIT;*WAI")              'Perform sweep with sync
CALL IBWRT(receiver%,"CALC:MARK:MAX")           'Set Marker1 to 100 MHz
CALL IBWRT(receiver%,"CALC:DELT:FUNC:FIX ON")   'Reference fixed

'-----Setting frequency, level and bandwidth for harmonic measurement -----
CALL IBWRT(receiver%,"FREQ:CENT 400MHz;Span 1MHz") 'Set freq. of 3rd harmonic
CALL IBWRT(receiver%,"BAND:RES 1kHz")           'and appropriate RBW
CALL IBWRT(receiver%,"SWEEP:TIME:AUTO ON")      'Couple sweep time
CALL IBWRT(receiver%,"INP:ATT:AUTO ON")         'Optimize level
CALL IBWRT(receiver%,"DISP:WIND:TRAC:Y:RLEV -50dBm")
CALL IBWRT(receiver%,"INIT;*WAI")              'Perform sweep with sync
CALL IBWRT(receiver%,"CALC:DELT:MODE REL")      'Delta marker frequency
                                           'relative
CALL IBWRT(receiver%,"CALC:DELT:MAX;X?;Y?")    'Read out delta marker
Call ibrd(receiver%, result$)                  'Read out frequency and level

Print "Deltamarker 1: "; result$

END SUB

REM *****

```

Phase and Phase Noise Measurement

During phase noise measurement the noise power referred to 1 Hz is brought into proportion to the power of an adjacent carrier signal. The spacing often used between the measured frequency and the carrier frequency is 10 kHz.

For the noise measurement the measured absolute level is referred to a bandwidth of 1 Hz.

The following example is again based on a signal with a level of -30 dBm at 100 MHz. Two markers are used to determine the noise and the phase noise at an offset of 10 kHz from the carrier signal.

```

REM *****
Public Sub Noise()

result$ = Space$(100)

'----- R&S ESCI default setting -----
----

CALL SetupStatusReg           'Configure status register
CALL IBWRT(receiver%,"*RST")  'Reset instrument
CALL IBWRT(receiver%,"INIT:CONT OFF") 'Single sweep

'----- Set frequency -----
CALL IBWRT(receiver%,"FREQUENCY:CENTER 100MHz") 'Center frequency
CALL IBWRT(receiver%,"FREQ:SPAN 100 kHz")       'Span

'----- Set level -----
CALL IBWRT(receiver%,"DISP:WIND:TRAC:Y:RLEV -20dBm") 'Reference level
CALL IBWRT(receiver%,"INIT;*WAI")                   'Perform sweep with sync

'----- Set reference point -----
CALL IBWRT(receiver%,"CALC:MARK:PEXC 6DB")          'Peak excursion
CALL IBWRT(receiver%,"CALC:MARK:STAT ON")           'Marker 1 on
CALL IBWRT(receiver%,"CALC:MARK:TRAC 1")           'Assign marker1 to trace1
CALL IBWRT(receiver%,"CALC:MARK:MAX")               'Set marker1 to 100 MHz
CALL IBWRT(receiver%,"CALC:DELT:FUNC:PNO ON")       'Define phase noise
                                                    'reference point

'----- Measure phase noise -----
CALL IBWRT(receiver%,"CALC:DELT:X 10kHz")           'Set delta marker
CALL IBWRT(receiver%,"CALC:DELT:FUNC:PNO:RES?")     'Read out result of
Call ibrd(receiver%, result$)                       'phase noise meas.
Print "Phase Noise [dBc/Hz]: "; result$

'----- Measure noise -----
CALL IBWRT(receiver%,"CALC:MARK:X 99.96MHz")        'Set Marker 1
CALL IBWRT(receiver%,"CALC:MARK:FUNC:NOIS:RES?")    'Read out result
Call ibrd(receiver%, result$)
Print "Noise [dBm/Hz]: "; result$

END SUB

REM *****

```

Shape Factor Measurement (using n dB down)

The n-dB-down function of the R&S ESCI is used twice to determine the shape factor of a filter (ratio of bandwidths at 60 dB and 3 dB below the filter maximum).

The following example is again based on a signal with a level of -30 dBm at 100 MHz. The shape factor is determined for the 30 kHz resolution bandwidth. The default setting of the R&S ESCI is used for measurements (SetupInstrument).

```

REM *****
Public Sub ShapeFactor()

result$ = Space$(100)

'----- R&S ESCI default setting -----
-
CALL SetupInstrument                'Default setting
CALL IBWRT(receiver%,"INIT:CONT OFF")  'Single sweep

'----- Set frequency -----
CALL IBWRT(receiver%,"FREQ:SPAN 1MHz")  'Span
CALL IBWRT(receiver%,"BAND:RES 30kHz")  'Resolution bandwidth
CALL IBWRT(receiver%,"INIT;*WAI")      'Perform sweep with sync

'----- Measure 60 dB value -----
CALL IBWRT(receiver%,"CALC:MARK:PEXC 6DB")  'Peak excursion
CALL IBWRT(receiver%,"CALC:MARK:STAT ON")  'Marker1 on
CALL IBWRT(receiver%,"CALC:MARK:TRAC 1")  'Assign marker1 to trace1
CALL IBWRT(receiver%,"CALC:MARK:MAX")      'Set marker1 to 100 MHz

CALL IBWRT(receiver%,"CALC:MARK:FUNC:NDBD 60dB") 'Read out bandwidth measured
CALL IBWRT(receiver%,"CALC:MARK:FUNC:NDBD:RES?") 'at 60 dB
CALL IBRD(receiver%,result$)

result60 = Val(result$)

'----- Measure 3 dB Down value -----
CALL IBWRT(receiver%,"CALC:MARK:FUNC:NDBD 3dB") 'Read out bandwidth measured
CALL IBWRT(receiver%,"CALC:MARK:FUNC:NDBD:RES?") 'at 60 dB
CALL IBRD(receiver%,result$)

result3 = Val(result$)

'----- Read out shape factor-----
Print "Shapfaktor 60dB/3dB: ";result60/result3

END SUB

REM *****

```

Measuring the Third Order Intercept Point

The third order intercept point (TOI) is the (virtual) level of two adjacent useful signals at which the intermodulation products of third order have the same level as the useful signals.

The intermodulation product at f_{s2} is obtained by mixing the first harmonic of the useful signal P_{N2} with signal P_{N1} , the intermodulation product at f_{s1} by mixing the first harmonic of the useful signal P_{N1} with signal P_{N2} .

$$f_{s1} = 2 \times f_{n1} - f_{n2}(1)$$

$$f_{s2} = 2 \times f_{n2} - f_{n1}(2)$$

The following example is based on two adjacent signals with a level of -30 dBm at 100 MHz and 110 MHz. The intermodulation products lie at 90 MHz and 120 MHz according to the above formula. The frequency is set so that the examined mixture products are displayed in the diagram. Otherwise, the default setting of the R&S ESCI is used for measurements (SetupInstrument).

```

REM *****
Public Sub TOI()

result$ = Space$(100)

'----- R&S ESCI default setting -----
----

CALL SetupStatusReg           'Set status registers
CALL IBWRT(receiver%,"*RST")  'Reset instrument
CALL IBWRT(receiver%,"INIT:CONT OFF") 'Single sweep
CALL IBWRT(receiver%,"SYST:DISP:UPD ON") 'ON: display on
                                         'OFF: off

'----- Set frequency -----
CALL IBWRT(receiver%,"FREQ:START 85MHz;STOP 125 MHz") 'Span

'----- Set level -----
CALL IBWRT(receiver%,"DISP:WIND:TRAC:Y:RLEV -20dBm") 'Reference level
CALL IBWRT(receiver%,"INIT;*WAI") 'Perform sweep with sync

'----- TOI measurement -----
CALL IBWRT(receiver%,"CALC:MARK:PEXC 6DB") 'Peak excursion
CALL IBWRT(receiver%,"CALC:MARK:FUNC:TOI ON") 'Switch on TOI measurement
CALL IBWRT(receiver%,"CALC:MARK:FUNC:TOI:RES?") 'and read out results
CALL IBRD(receiver%,result$)

'----- Read out result -----

Print "TOI [dBm]: ";result$

END SUB

REM *****

```

Measuring the AM Modulation Depth

The example below is based on an AM-modulated signal at 100 MHz with the following characteristics:

- Carrier signal level: -30 dBm
- AF frequency: 100 kHz
- Modulation depth: 50 %

The default setting of the receiver for measurements can be used for the measurements described below (SetupInstrument).

```

REM *****
Public Sub AMMod()

result$ = Space$(100)
CALL SetupInstrument           'Default setting

'----- Peak search -----
CALL IBWRT(receiver%,"INIT:CONT OFF")      'Single sweep
CALL IBWRT(receiver%,"INIT;*WAI")         'Perform sweep with sync

CALL IBWRT(receiver%,"CALC:MARK:PEXC 6DB") 'Peak excursion
CALL IBWRT(receiver%,"CALC:MARK:STAT ON")  'Marker 1 on
CALL IBWRT(receiver%,"CALC:MARK:TRAC 1")   'Assign marker1 to tracen

'----- Measure modulation depth-----
CALL IBWRT(receiver%,"CALC:MARK:MAX;FUNC:MDEP ON") 'Marker to Peak;
CALL IBWRT(receiver%,"CALC:MARK:FUNC:MDEP:RES?")  'Measure mod. depth
CALL IBRD(receiver%, result$)                    'Read out result

'----- Read out result -----
Print "AM Mod Depth [%]: ";result$

END SUB
REM *****

```

Limit Lines and Limit Test

The example below shows the definition and use of a new limit line 5 for trace 1 on screen A and trace 2 on screen B with the following characteristics:

- Upper limit line
- Absolute x axis in the frequency range
- 5 reference values: 120 MHz / -70 dB, 126 MHz/-40 dB, 127 MHz/-40 dB, 128 MHz/-10 dB, 129 MHz/-40 dB, 130 MHz/-40 dB, 136 MHz / -70 dB
- Relative y axis with unit dB
- Absolute threshold at -75 dBm
- No margin

The signal of the integrated calibration source (128 MHz, -30 dBm) is used to check the limit test.

```

REM *****
Public Sub LimitLine()

result$ = Space$(100)

'----- R&S ESCI default setting -----
----

CALL SetupInstrument                'Default setting
CALL IBWRT(receiver%,"FREQUENCY:CENTER 128MHZ;Span 10MHZ")'Span
Call ibwrt(receiver%,"Diag:Serv:Inp Cal;CSO -30dBm")  'Cal signal on

'----- Definition of limit lines -----

CALL IBWRT(receiver%,"CALC:LIM5:NAME 'TEST1'")        'Define name
CALL IBWRT(receiver%,"CALC:LIM5:COMM 'Upper limit'")  'Define comment

CALL IBWRT(receiver%,"CALC1:LIM5:TRAC 1")            'Assign trace in screen A
CALL IBWRT(receiver%,"CALC2:LIM5:TRAC 2")            'Assign trace in screen B

CALL IBWRT(receiver%,"CALC:LIM5:CONT:DOM FREQ")      'Define x axis range
CALL IBWRT(receiver%,"CALC:LIM5:CONT:MODE ABS")      'Define x axis scaling

CALL IBWRT(receiver%,"CALC:LIM5:UNIT DB")            'Define y axis unit
CALL IBWRT(receiver%,"CALC:LIM5:UPP:MODE REL")       'Define y axis scaling

'----- Definition of data points and threshold -----

xlimit$ = "CALC:LIM5:CONT 120MHZ,126MHZ,127MHZ,128MHZ,129MHZ,130MHZ,136MHZ"
CALL IBWRT(receiver%, xlimit$)                       'Set values for x axis

CALL IBWRT(receiver%,"CALC:LIM5:UPP -70,-40,-40,-20,-40,-40,-70")
                                                    'Set values for y axis

CALL IBWRT(receiver%,"CALC:LIM5:UPP:THR -75DBM")     'Set y threshold (only
                                                    'possible for relative
                                                    'y axis)

'-----

'A margin or an x /y offset can be defined here.

'----- Activate and evaluate the limit line in screen A -----

CALL IBWRT(receiver%,"CALC1:LIM5:UPP:STAT ON")      'Activate line 5 in screen A
CALL IBWRT(receiver%,"CALC1:LIM5:STAT ON")          'Activate limit check in
                                                    'screen A

CALL IBWRT(receiver%,"INIT;*WAI")                   'Perform sweep with sync

```



```

CALL IBWRT(receiver%,"CALC1:LIM5:FAIL?")      'Query result of limit
                                              'check
CALL IBRD(receiver%, result$)                'Result: 1 (= FAIL)
'----- Read out result -----
Print "Limit Result Line 5: ";result$

'----- Evaluate limit line in screen A by means of status register -----
CALL IBWRT(receiver%,"*CLS")                  'Reset status register
'----- Measure -----
CALL IBWRT(receiver%,"INIT;*OPC")            'Perform sweep with sync
CALL WaitSRQ(boardID%,status%)              'Wait for service request
'----- Read out result -----
IF (status% = 1) THEN
    CALL IBWRT(receiver%,"STAT:QUES:LIM1:COND?") 'Read out STAT:QUES:LIMit
    CALL IBRD(receiver%, result$)              'register
    IF ((Val(result$) And 16) <> 0) THEN
        Print "Limit5 failed"
    ELSE
        Print "Limit5 passed"
    END IF
END IF
END SUB
REM *****

```

Measuring the Channel and Adjacent Channel Power

In the following example, the channel and adjacent channel power is first measured on a signal with a level of 0 dBm at 800 MHz to IS95. Then the channel and adjacent channel power is measured on a GSM signal at 935.2 MHz with fast ACP measurement (FAST ACP).

In addition, the limit test is activated.

```

REM *****
Public Sub ACP()

result$ = Space$(100)

'----- R&S ESCI default setting -----
----

CALL SetupStatusReg           'Set status register
CALL IBWRT(receiver%,"*RST")  'Reset instrument
CALL IBWRT(receiver%,"INIT:CONT OFF") 'Single sweep
CALL IBWRT(receiver%,"SYST:DISP:UPD ON") 'ON: display on
                                   'OFF: off

'----- Set frequency -----
CALL IBWRT(receiver%,"FREQ:CENT 800MHz") 'Set frequency

'----- Set level -----
CALL IBWRT(receiver%,"DISP:WIND:TRAC:Y:RLEV 10dBm") 'Reference level

'----- Example 1: Configure CP/ACP for CDMA -----
CALL IBWRT(receiver%,"CALC2:MARK:FUNC:POW:SEL ACP") 'ACP measurement on
CALL IBWRT(receiver%,"CALC:MARK:FUNC:POW:PRES F8CDMA") 'Select CDMA800 FWD
CALL IBWRT(receiver%,"SENS:POW:ACH:ACP 2") 'Select 2 adjacent channels
CALL IBWRT(receiver%,"SENS:POW:ACH:PRES ACP") 'Optimize settings
CALL IBWRT(receiver%,"SENS:POW:ACH:PRES:RLEV") 'Optimize reference level
CALL IBWRT(receiver%,"SENS:POW:ACH:MODE ABS") 'Absolute measurement
CALL IBWRT(receiver%,"SENS:POW:HSP ON") 'Fast ACP measurement

'----- Perform measurement and query results -----
CALL IBWRT(receiver%,"INIT;*WAI") 'Perform sweep with sync
CALL IBWRT(receiver%,"CALC2:MARK:FUNC:POW:RES? ACP") 'Query result
CALL IBRD(receiver%, result$)

'----- Read out result -----
Print "Result (CP, ACP low, ACP up, Alt low, Alt up): "
Print result$

```

```

'----- Example 2: Configure CP/ACP manually for GSM -----
result$ = Space$(100)
CALL IBWRT(receiver%,"FREQ:CENT 935.2MHz")      'Set frequency
CALL IBWRT(receiver%,"CALC:MARK:FUNC:POW:SEL ACP") 'ACP measurement on
CALL IBWRT(receiver%,"SENS:POW:ACH:ACP 1")      '1 adjacent channel
CALL IBWRT(receiver%,"SENS:POW:ACH:BAND 200KHZ") 'Channel bandw. 200 kHz
CALL IBWRT(receiver%,"SENS:POW:ACH:BAND:ACH 200KHZ") 'Adjacent channel band-
                                                    'width 200 kHz
CALL IBWRT(receiver%,"SENS:POW:ACH:SPAC 200KHZ") 'Channel spacing 200 kHz
CALL IBWRT(receiver%,"SENS:POW:ACH:PRES ACP")   'Optimize settings
CALL IBWRT(receiver%,"SENS:POW:ACH:PRES:RLEV")  'Optimize reference level
CALL IBWRT(receiver%,"SENS:POW:ACH:MODE ABS")   'Absolute measurement

'----- Start measurement and query result -----
CALL IBWRT(receiver%,"INIT;*WAI")              'Perform sweep with sync
CALL IBWRT(receiver%,"CALC:MARK:FUNC:POW:RES? ACP") 'Query result
CALL IBRD(receiver%, result$)

'----- Read out result -----
Print "Result (CP, ACP low, ACP up): "
Print result$

'----- Active limit check -----
result$ = Space$(100)
CALL IBWRT(receiver%,"CALC:LIM:ACP:ACH 30DB, 30DB") 'Set relative limit
CALL IBWRT(receiver%,"CALC:LIM:ACP:ACH:ABS -35DBM,-35DBM")
                                                    'Set absolute limit
CALL IBWRT(receiver%,"CALC:LIM:ACP:ACH:STAT ON")   'Rel. limit check on
CALL IBWRT(receiver%,"CALC:LIM:ACP:ACH:ABS:STAT ON") 'Abs. limit check on
CALL IBWRT(receiver%,"CALC:LIM:ACP ON")            'Limit check on

'----- Start measurement and query result -----
CALL IBWRT(receiver%,"INIT;*WAI")              'Perform sweep with
sync
CALL IBWRT(receiver%,"CALC:LIM:ACP:ACH:RES?")     'Query result of
CALL IBRD(receiver%, result$)                   'limit check

'----- Read out result -----
Print "Result Limit Check: ";result$

END SUB

REM *****

```

Occupied Bandwidth Measurement

In the following example, the bandwidth is to be found in which 95% of the power of a GSM signal is contained. Signal frequency is 935,2 MHz; channel bandwidth is 200 kHz.

```

REM *****
Public Sub OBW()

result$ = Space$(100)

'----- R&S ESCI default setting -----
-----
CALL SetupStatusReg           'Set status register
CALL IBWRT(receiver%,"*RST")  'Reset instrument
CALL IBWRT(receiver%,"INIT:CONT OFF") 'Single sweep
CALL IBWRT(receiver%,"SYST:DISP:UPD ON") 'ON: display on
                                      'OFF: off

'----- Configure R&S ESCI for OBW for GSM -----
CALL IBWRT(receiver%,"FREQ:CENT 935.2MHz")           'Set frequency
CALL IBWRT(receiver%,"CALC:MARK:FUNC:POW:SEL OBW")  'OBW measurement on
CALL IBWRT(receiver%,"SENS:POW:ACH:BAND 200KHZ")    'Channel bandw. 200 kHz
CALL IBWRT(receiver%,"SENS:POW:BWID 95PCT")         'Percentage of power
CALL IBWRT(receiver%,"SENS:POW:ACH:PRES OBW")       'Set frequency and
CALL IBWRT(receiver%,"SENS:POW:ACH:PRES:RLEV")     'optimize reference level
CALL IBWRT(receiver%,"SENS:POW:NCOR OFF")           'Noise correction
                                      'OFF: switch off
                                      'ON:  switch on

'----- Perform measurement and query results -----
CALL IBWRT(receiver%,"INIT;*WAI")                   'Perform sweep with sync
CALL IBWRT(receiver%,"CALC:MARK:FUNC:POW:RES? OBW") 'Query result
CALL IBRD(receiver%, result$)

Print result$

END SUB

REM *****

```

Time Domain Power Measurement

In the following example, the mean carrier power of a signal with 300 kHz bandwidth at 100 MHz is to be determined. In addition, the peak power, the rms value and the standard deviation are measured. To do this, the time-domain-power measurement functions are used.

```

REM *****
Public Sub TimeDomainPower()

result$ = Space$(100)

'----- R&S ESCI default setting -----
----

CALL SetupStatusReg           'Set status register
CALL IBWRT(receiver%,"*RST")  'Reset instrument
CALL IBWRT(receiver%,"INIT:CONT OFF") 'Single sweep
CALL IBWRT(receiver%,"SYST:DISP:UPD ON") 'ON: display on
                                      'OFF: off

'----- Configure R&S ESCI for time domain power measurement -----

CALL IBWRT(receiver%,"FREQ:CENT 100MHz;SPAN 0Hz") 'Set frequency
CALL IBWRT(receiver%,"BAND:RES 300kHz")           'Resolution bandwidth
CALL IBWRT(receiver%,"SWE:TIME 200US")           'Sweep time

CALL IBWRT(receiver%,"CALC:MARK:FUNC:SUMM:PPE ON") 'Peak measurement on
CALL IBWRT(receiver%,"CALC:MARK:FUNC:SUMM:MEAN ON") 'Mean measurement on
CALL IBWRT(receiver%,"CALC:MARK:FUNC:SUMM:RMS ON") 'RMS measurement on
CALL IBWRT(receiver%,"CALC:MARK:FUNC:SUMM:SDEV ON") 'Standard deviation on

'----- Perform measurement and query results -----

CALL IBWRT(receiver%,"INIT;*WAI")                 'Perform sweep with sync

query$ =          " CALC:MARK:FUNC:SUMM:PPE:RES?;" 'Query results:
query$ = query$ + ":CALC:MARK:FUNC:SUMM:MEAN:RES?;" 'Peak measurement
query$ = query$ + ":CALC:MARK:FUNC:SUMM:RMS:RES?;"  'Mean measurement
query$ = query$ + ":CALC:MARK:FUNC:SUMM:SDEV:RES?;" 'RMS measurement
Call IBWRT(receiver%, query$) 'Standard deviation

CALL IBRD(receiver%, result$)

Print result$

END SUB

REM *****

```

Fast Power Measurement on Power Ramps

A frequent task in mobile radio tests is measurement of a DUT at various power control levels at the highest possible speed. The R&S ESCI offers two test functions for this task, which can be used depending on the signal characteristics.

In the following, the two methods are presented by means of two examples.

Power Measurement with Multi-Summary Marker

The multi-summary marker function is suitable for measuring the power of a sequence of pulses with the following characteristics:

- The pulses occur at identical time intervals, which is typical of GSM transmission in slots, for example.
- The level of the first signal is reliably above threshold.
- The subsequent pulses may have any levels.

The function uses the first pulse as a trigger signal. The power of the subsequent pulses is determined exclusively via the timing pattern selected for the pulse sequence. The function is, therefore, suitable for adjustments where the DUT output power varies considerably and is not reliably above the trigger threshold.

The measurement accuracy is determined by the ratio of pulse duration to total measurement time; this should not be below 1:50.

The function always uses TRACE 1 of the selected screen.

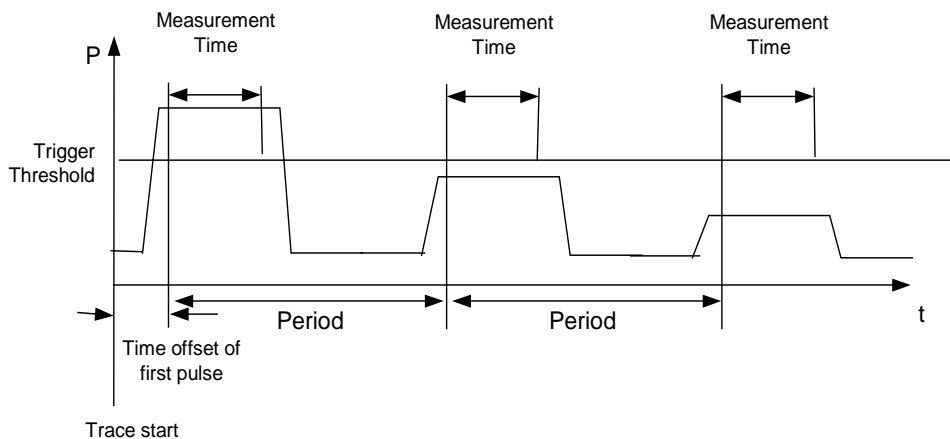

Fig. 7-1 Block diagram illustrating signal processing in analyzer

In the example below, a sequence of 8 pulses is measured with an offset of 50 μs of the first pulse, 450 μs measurement time/pulse and 576.9 μs pulse period.

```

REM *****
Public Sub MultiSumMarker()

result$ = Space$(200)

'----- R&S ESCI default setting-----
CALL SetupStatusReg           'Configure status register
CALL IBWRT(receiver%,"*RST")  'Reset instrument
CALL IBWRT(receiver%,"INIT:CONT OFF") 'Single sweep mode
CALL IBWRT(receiver%,"SYST:DISP:UPD ON") 'ON: switch display on
                                         'OFF: switch display off

'----- Configure R&S ESCI for power measurement in time domain -----
-----
CALL IBWRT(receiver%,"FREQ:CENT 935.2MHz;SPAN 0Hz") 'Frequency setting
CALL IBWRT(receiver%,"DISP:WIND:TRAC:Y:RLEV 10dBm") 'Set reference level
                                                         'to 10 dB

CALL IBWRT(receiver%,"INP:ATT 30 dB") 'Set input attenuation
                                         'to 30 dB

CALL IBWRT(analyzer%,"BAND:RES 1MHz;VID 3MHz") 'Bandwidth setting
CALL IBWRT(analyzer%,"DET RMS") 'Select RMS detector
CALL IBWRT(analyzer%,"TRIG:SOUR VID") 'Trigger source: video
CALL IBWRT(analyzer%,"TRIG:LEV:VID 50 PCT") 'Trigger threshold: 50%
CALL IBWRT(analyzer%,"SWE:TIME 50ms") 'Sweep time ≥ 1 frame

'----- Perform measurement and query results -----
CALL IBWRT(receiver%,"INIT;*WAI") 'Perform sweep with sync
                                         'Query results:

cmd$ = "CALC:MARK:FUNC:MSUM? "
cmd$ = cmd$ + "50US," 'Offset of first pulse
cmd$ = cmd$ + "450US," 'Measurement time
cmd$ = cmd$ + "576.9US," 'Pulse period
cmd$ = cmd$ + "8" 'Number of bursts
CALL IBWRT(analyzer%,cmd$)
CALL IBRD(receiver%, result$) 'Read results
Print result$
END SUB
REM *****

```

Multi-Burst Power Measurement

The multi-burst power measurement function is suitable for measuring the power of a sequence of pulses with the following characteristics:

- The pulses occur at variable time intervals.
- The levels of all pulses of the sequence are reliably above the trigger threshold, or an external trigger signal is used.

The function requires one trigger event per pulse. This means that if the video trigger or the IF power trigger is used, the levels of all pulses must be above the trigger threshold.

The function is, therefore, particularly suitable for re-measuring DUTs already adjusted and whose output power is within the specified range. The measurement is optimized for minimum overhead relative to the actual measurement time.

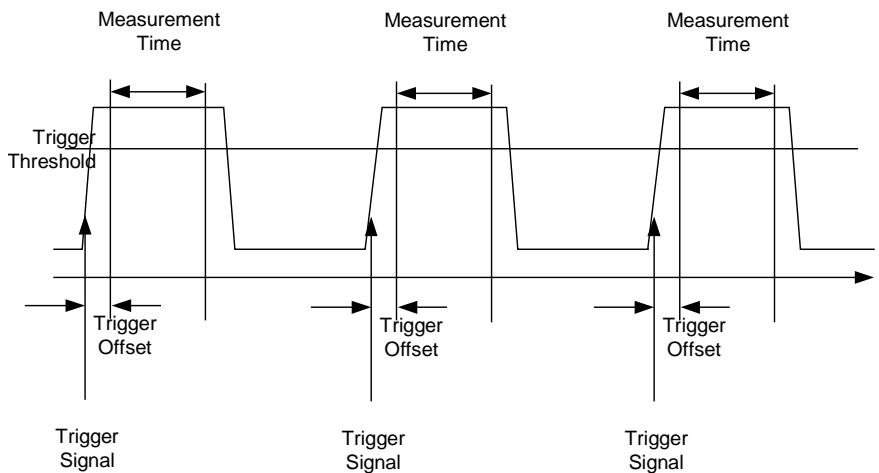

Fig. 7-2 Block diagram illustrating signal processing in analyzer

Either the root-mean-square power or the peak power is measured, depending on whether the RMS detector or the PEAK detector is selected. The function always uses TRACE 1 of the selected screen.

The following parameters are to be set for this measurement:

- Analyzer frequency
- Resolution bandwidth
- Measurement time per single pulse
- Trigger source
- Trigger threshold
- Trigger offset
- Type of power measurement (PEAK, MEAN)
- Number of pulses to be measured

During the measurement, each pulse is mapped into a pixel of the screen, i.e. any change of the trace can be detected only at the left-hand edge of the screen. Maximum measurement speed is as usual achieved with the display switched off.

In the example below, a GSM pulse sequence of 8 pulses is measured with 5 μs trigger offset, 434 μs measurement time/pulse, video trigger with 50% trigger threshold, and peak detection:

```

REM *****
Public Sub MultiBurstPower()

result$ = Space$(200)
'----- R&S ESCI default setting -----
-----
CALL SetupStatusReg           'Configure status register
CALL IBWRT(receiver%,"*RST")  'Reset instrument
CALL IBWRT(receiver%,"INIT:CONT OFF") 'Single sweep mode
CALL IBWRT(receiver%,"SYST:DISP:UPD OFF") 'OFF: display off
'----- Perform measurement and query results -----
cmd$ = "MPOW? "
cmd$ = cmd$ + "935.2 MHZ,"      'Center frequency
cmd$ = cmd$ + "1MHZ,"          'Resolution bandwidth
cmd$ = cmd$ + "434US,"         'Measurement time
cmd$ = cmd$ + "VID,"           'Trigger source
cmd$ = cmd$ + "50PCT,"         'Trigger threshold
cmd$ = cmd$ + "1US,"           'Trigger offset, must be > 125 ns
cmd$ = cmd$ + "PEAK,"          'Peak detector
cmd$ = cmd$ + "8"              'Number of bursts
CALL IBWRT(analyzer%, cmd$)
CALL IBRD(receiver%, result$) 'Read results
Print result$
END SUB
REM *****

```

Fast Level Measurement Using Frequency Lists

A typical task for the R&S ESCI is power measurement at a number of frequency points, e.g. at multiples of the fundamental (harmonics measurement), or at frequencies defined by a mobile radio standard (e.g. spectrum due to transients at ± 200 kHz, ± 400 kHz, etc about the carrier frequency of a GSM signal). In many cases, different level and/or bandwidth settings are required for the different frequency points to match the channel spacing and meet the requirements of dynamic range.

Especially for this application, the R&S ESCI offers a number of remote-control functions (commands available in SENSE:LIST subsystem) that allow level measurement based on a frequency list with different instrument settings assigned to different frequencies. Not only the frequency list can be programmed, but also the measurement types (PEAK, RMS, AVG) to be performed simultaneously can be selected.

The example below describes a harmonics measurement on a dual-band amplifier. The harmonics level in general decreases as the frequency increases. To boost measurement sensitivity, therefore, the reference level is lowered by 10 dB from the third harmonic.

The following settings are used:

Reference level: 10.00 dBm up to 2nd harmonic, 0 dBm from 3rd harmonic
 RF attenuation: 20 dB
 Electronic attenuation: 0 dB
 RBW: 1 MHz
 VBW: 3 MHz
 Filter type: NORMal
 Measurement time: 300 μ s
 Trigger delay: 100 μ s
 Trigger: video, 45 %

Frequency	Type
935.2 MHz	GSM 900 fundamental
1805.2 MHz	GSM 1800 fundamental
1870.4 MHz	GSM 900 2nd harmonic
2805.6 MHz	GSM 900 3rd harmonic
3610.4 MHz	GSM 1800 2nd harmonic
3740.8 MHz	GSM 900 4th harmonic
5815.6 MHz	GSM 1800 3rd Harmonic

The frequencies are selected in ascending order to minimize system-inherent waiting times resulting from frequency changes.

At each frequency point the peak power and the rms power are measured. The peak power and the rms power values are stored alternately in the results memory.

```

REM *****
Public Sub FrequencyList()

result$ = Space$(500)

'----- R&S ESCI default setting -----
---

CALL SetupStatusReg           'Configure status register
CALL IBWRT(receiver%,"*RST")  'Reset instrument
CALL IBWRT(receiver%,"INIT:CONT OFF") 'Single sweep mode
CALL IBWRT(receiver%,"SYST:DISP:UPD OFF") 'Display off

'-----Configure R&S ESCI for power measurement based on frequency list -
-----

Call IBWRT(analyzer%,"TRIG:LEV:VID 45PCT") 'Video trigger threshold
Call IBWRT(analyzer%,"LIST:POWER:SET ON,ON,OFF,VID,POS,100us,0")

'----- Perform measurement and query results -----

cmd$ = "LIST:POWER? "
cmd$ = cmd$ + "935.2MHZ,10dBm,20dB,OFF,NORM,1MHz,3MHz,300us,0,"
cmd$ = cmd$ + "1805.2MHZ,10dBm,20dB,OFF,NORM,1MHz,3MHz,300us,0,"
cmd$ = cmd$ + "1870.4MHZ,10dBm,20dB,OFF,NORM,1MHz,3MHz,300us,0,"
cmd$ = cmd$ + "2805.6MHZ,0dBm,20dB,OFF,NORM,1MHz,3MHz,300us,0,"
cmd$ = cmd$ + "3610.4MHz,10dBm,20dB,OFF,NORM,1MHz,3MHz,300us,0,"
cmd$ = cmd$ + "3740.8MHz,0dBm,20dB,OFF,NORM,1MHz,3MHz,300us,0,"
cmd$ = cmd$ + "5815.6MHz,0dBm,20dB,OFF,NORM,1MHz,3MHz,300us,0"
Call IBWRT(analyzer%, cmd$)
Call IBRD(analyzer%, result$)
Print result$

END SUB
REM *****

```

Level Correction of Transducers (Definition of Transducer Factors)

In more complex test systems, the frequency response of the test setup must be taken into account in all power measurements to avoid any measurement errors being introduced from sources other than the DUT.

The R&S ESCI offers the possibility of defining a frequency-dependent attenuation correction factor (transducer factor).

In the example below, a factor with the following characteristics is defined:

Name: Transtest
 Unit: dB
 Scaling: lin
 Comment: simulated cable correction

Frequency	Level
10 MHz	0 dB
100 MHz	3 dB
1 GHz	7 dB
3 GHz	10 dB

The factor is defined and can be activated as required.

```

REM *****
Public Sub TransducerFactor()

'----- Define transducer factor -----
CALL IBWRT(receiver%,"CORR:TRAN:SEL 'TRANSTEST'")
                                     'Define "Transtest"
                                     'transducer factor

CALL IBWRT(receiver%,"CORR:TRAN:UNIT 'DB'") 'Unit 'dB'
CALL IBWRT(receiver%,"CORR:TRAN:SCAL LIN")  'Linear frequency axis
CALL IBWRT(receiver%,"CORR:TRAN:COMM 'Simulated cable correction'")

cmd$ = "CORR:TRAN:DATA "                'Enter frequency and level
cmd$ = cmd$ + "10MHz, 0,"                'values. Level values without
cmd$ = cmd$ + "100MHz, 3,"               'unit!
cmd$ = cmd$ + "1GHz, 7,"
cmd$ = cmd$ + "3GHz, 10"

CALL IBWRT(receiver%,cmd$)                'Enter frequency and level values

'----- Activate transducer -----
CALL IBWRT(receiver%,"CORR:TRAN:STAT ON") 'Activate transducer factor

END SUB
REM *****

```

Reading Trace Data

In the following example, the trace data recorded together at the default setting is read out and displayed on the screen in the form of a list. Reading is performed consecutively in the binary format and in the ASCII format, at span > 0 and also at span = 0.

In the binary format the message header is evaluated with the length information and used to calculate the x axis values.

In the ASCII format only the list of level values is output.

The binary data is read out in 3 steps:

1. Reading the number of digits of the length information
2. Reading the length information
3. Reading trace data

This procedure is necessary with programming languages that support only structures with similar data types (arrays) (such as Visual Basic) since the data types of header and data differ in binary data.

Note: *The trace data arrays are dimensioned in such a way that they can accommodate the trace data of the FSU (625 points).*

```

REM *****
Public Sub ReadTrace()

'----- Define variables -----
Dim traceData(1250) As Single      'Buffer for floating point
                                   'binary data
Dim digits As Byte                'Number of digits of
                                   'length information
Dim traceBytes As Integer         'Length of trace data in bytes
Dim traceValues As Integer       'Number of values in buffer
asciiResult$ = Space$(25000)     'Buffer for ASCII trace data
result$ = Space$(100)            'Buffer for simple results
startFreq$ = Space$(100)        'Buffer for start frequency
span$ = Space$(100)             'Buffer for span

'----- R&S ESCI default setting -----
---
CALL SetupInstrument              'Default setting
CALL IBWRT(receiver%,"INIT:CONT OFF") 'Single sweep
CALL IBWRT(receiver%,"INIT;*WAI")  'Perform sweep with sync

'----- Define span for read out -----
Call ibwrt(receiver%,"FREQ:START?") 'Read out start frequency
Call ibrd(receiver%,startFreq$)
startFreq = Val(startFreq$)

Call ibwrt(receiver%,"FREQ:SPAN?") 'Read out span
Call ibrd(receiver%,span$)
span = Val(span$)

```

```

'----- Read out in binary format -----
Call ibwrt(receiver%, "FORMAT REAL,32")      'Select binary format
Call ibwrt(receiver%, "TRAC1? TRACE1")      'Read out trace 1
Call ilrd(receiver%, result$, 2)            'Read out and store
digits = Val(Mid$(result$, 2, 1))          'number of digits of
                                           'length information
result$ = Space$(100)                       'Initialize buffer again
Call ilrd(receiver%, result$, digits)        'Read out
traceBytes = Val(Left$(result$, digits))    'and store length information
Call ibrd32(receiver%, traceData(0), traceBytes) 'Read trace data into buffer
Call ilrd(receiver%, result$, 1)            'Read the terminator <NL>
'----- Read out binary data as pairs of frequency/level values -----
traceValues = traceBytes/4                  'Single precision = 4 bytes
stepsize = span/traceValues                 'Calculate frequency step width
For i = 0 To traceValues - 1
    Print "Value["; i; "] = "; startFreq+stepsize*i; ", "; traceData(i)
Next i
'----- Time domain default setting -----
Call ibwrt(receiver%, "FREQ:SPAN 0Hz")      Switchover to time domain
CALL IBWRT(receiver%, "INIT;*WAI")          'Perform sweep with sync
'----- Read out in ASCII format -----
Call ibwrt(receiver%, "FORMAT ASCII")       'Select ASCII format
CALL ibwrt(receiver%, "TRAC1? TRACE1")     'Read out Trace 1
CALL ibrd(receiver%, asciiResult$)
Print "Contents of Trace1: ",asciiResult$   'Output
END SUB
REM *****

```

Measuring the Magnitude and Phase of a Signal (I/Q Data Acquisition)

Due to the R&S ESCI's internal architecture, it is capable of measuring and outputting the magnitude and phase of a signal in addition to its power values. This opens up a variety of possibilities for more in-depth analysis (FFT, demodulation, etc).

The I/Q data is stored in memory areas each containing 512 k words. Hardware triggering controls the memory.

The I/Q data is stored in memory areas that each contain 16 M words. The data can then be read out from these areas in blocks that are 512 k words each. Hardware triggering controls the memory.

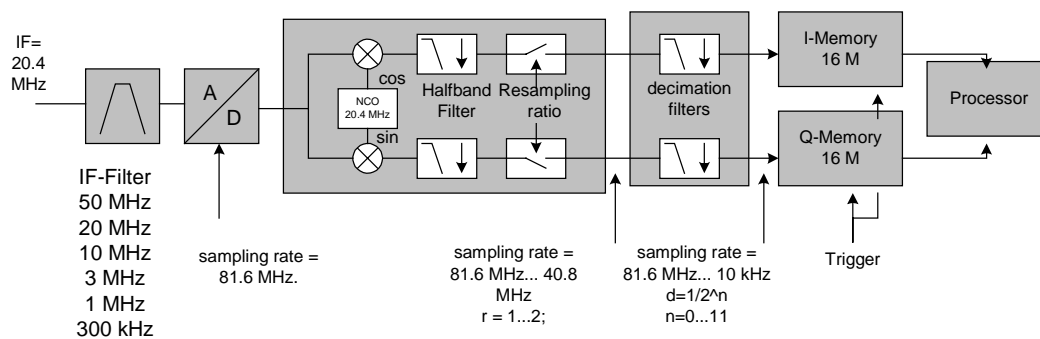

Fig. 7-3 Block diagram illustrating signal processing in the analyzer

The following maximum bandwidths are possible in this measurement depending on the selected sampling rate:

Sampling rate	Max. bandwidth	Remarks
32 MHz	9.6 MHz	
16 MHz	7.72 MHz	
8 MHz	4.8 MHz	Signals outside the specified bandwidth may be deconvoluted to the useful band due to the characteristics of the anti-aliasing filter.
4 MHz	2.8 MHz	
2 MHz	1.6 MHz	
1 MHz	800 kHz	
500 kHz	400 kHz	
250 kHz	200 kHz	
125 kHz	100 kHz	
62.5 kHz	50 kHz	
31.25 kHz	25 kHz	
15.625 kHz	12.5 kHz	

Due to the sampling concept of the FSU (21.4 MHz IF, 32 MHz sampling rate), the image frequency is band-limited only by the analog 10 MHz filter. For an input signal at the limit of the 10 MHz band (+ 5 MHz above center frequency), an image-frequency signal 800 kHz above the input signal would be obtained.

The image frequency in MHz is calculated as follows:

$$f_{\text{image}} = 2 \cdot (f_{\text{center}} + 5.4 \text{ MHz}) - f_{\text{signal}}$$

where

f_{image} = image frequency in MHz

f_{center} = center frequency in MHz

f_{signal} = frequency in MHz of signal measured

For correct measurements, the RF input signal must be band-limited. Signals spaced more than 5.4 MHz from the center frequency are reflected into the passband of the 10 MHz filter.

Analog prefilters (bandwidth ≥ 300 kHz) are available to provide additional band-limiting of the signal measured.

The following example shows the steps necessary to collect data at a predefined sampling rate and read it from the I/Q memory.

Data is output in the form of voltage values referred to the analyzer input. Data can be read in binary or ASCII format.

In binary format, the length information carried in the message header is evaluated and used for calculating the x axis values.

In ASCII format, only a list of voltage values is output.

Binary data is read in three steps:

1. The number of digits carrying the length information is read.
2. The length information itself is read.
3. The trace data is read.

This procedure is necessary with programming languages like Visual Basic which support only structures of identical data types (arrays), whereas the binary data format uses different data types in the header and the data section.

Note: *The arrays for measured data are dimensioned in such a way that they can accommodate 2 * 128 k * 4 byte.*

REM *****

Public Sub ReadIQData()

'----- Create variables -----

Dim IData(131072) As Single 'Buffer for floating-point
'I data (= 128*1024 bytes)

Dim QData(131072) As Single 'Buffer for floating-point
'Q data (= 128*1024 bytes)

'Note:
'Visual Basic cannot read in
'data volumes larger than
'128k words!

Dim digits As Byte 'No. of digits as length
Dim IQBytes As Long 'Length of trace data in bytes
Dim IQValues As Long 'No. of meas. values in buffer

asciiResult\$ = Space\$(6553600) 'Buffer for ASCII I/Q data
'(= 25*2*1024 bytes)

result\$ = Space\$(100) 'Buffer for simple results

'----- Default setting -----

```

CALL SetupInstrument                'Default setting
CALL IBWRT(receiver%,"TRAC:IQ:STAT ON")  'Activate I/Q data
                                         'acquisition mode; must be
                                         'done before TRAC:IQ:SET !

'Select number of test points (= 128 * 1024 - 512) at RBW 10 MHz,
'sample rate 32 MHz, trigger free run, pos. trigger edge and 0 s trigger
'delay.
CALL IBWRT(receiver%,"TRAC:IQ:SET NORM,10MHz,32MHz,IMM,POS,0,130560")

'----- Read-out in binary format-----
Call ibwrt(receiver%, "FORMAT REAL,32")      'Set binary format
Call ibwrt(receiver%, "TRAC:IQ:DATA?")      'Measure + read out I/Q data
Call ilrd(receiver%, result$, 2)            'Read and store length for
digits = Val(Mid$(result$, 2, 1))          'number of digits
result$ = Space$(100)                       'Re-initialize buffer
Call ilrd(receiver%, result$, digits)       'Read and store length
IQBytes = Val(Left$(result$, digits))       '
IQBytes = IQBytes / 2                       'Divide no. per buffer in
half
Call ibrd32(receiver%, IData(0), IQBytes)   'Read I data in buffer
Call ibrd32(receiver%, QData(0), IQBytes)   'Read Q data in buffer
Call ilrd(receiver%, result$, 1)          'Read in end character <NL>

'----- Output of binary data as frequency/level pair -----
IQValues = IQBytes/4                        'Single Precision = 4 Bytes
For i = 0 To IQValues - 1
  Print "I-Value["; i; "] = "; IData(i)
  Print "Q-Value["; i; "] = "; QData(i)
Next i

'----- Auslesen im ASCII-Format -----
Call ibwrt(receiver%,"FORMAT ASCII")        'Set ASCII format
Call ibwrt(receiver%, "TRAC:IQ:DATA?")      'Re-measure and read out
'I/Q data
CALL ibrd(receiver%, asciiResult$)
CALL IBWRT(receiver%,"TRAC:IQ:STAT OFF")    'Stop I/Q data aquisition
'mode if no further
'measurements are to be
'done

END SUB
REM *****

```

Averaging I/Q Data

The R&S ESCI has averaging capability also for I/Q measurements, i.e. I/Q data can be averaged over several test runs. This is subject to the following conditions:

1. An external trigger signal must be available for data measurement, and the trigger signal must be phase-locked to the signal measured.
2. The same reference-frequency signal must be used for the DUT and the R&S ESCI.
3. The sampling rate must be 32 MHz, since only with this sampling frequency will the measurement be performed phase-synchronous with the trigger signal.

If all of the above conditions are fulfilled, no phase shift will occur between consecutive test runs. Phase shift may invalidate the measured average so that in extreme cases a value of 0 is obtained.

The default setting of the instrument for data measurement without averaging has to be changed as follows:

```
'----- R&S ESCI default setting -----
--
CALL SetupInstrument           'Default setting
CALL IBWRT(receiver%,"TRAC:IQ:STAT ON")  'Activate I/Q data acquisition
                                         'mode; this must be
                                         'done before TRAC:IQ:SET!

'Select max. number of test points (= 128 * 1024 - 512) at 10 MHz RBW,
'S32 MHz sampling rate, external trigger, pos. trigger edge and 0 s trigger
'delay.
CALL IBWRT(receiver%,"TRAC:IQ:SET NORM,10MHz,32MHz,EXT,POS,0,130560")
CALL IBWRT(receiver%,"TRAC:IQ:AVER ON")   'Switch on I/Q averaging
CALL IBWRT(receiver%,"TRAC:IQ:AVER:COUN 10") 'Set 10 test runs

'----- Read data in binary format -----
...

```

Storing and Loading Device Settings

Storing Instrument Settings

In the following example, the settings/measurement data to be stored are determined; only the hardware settings are stored. The selection commands for the other settings are indicated with the status OFF for the sake of completeness.

```

REM *****
Public Sub StoreSettings()

' This subroutine selects the settings to be stored and creates
' the data set "TEST1" in directory D:\USER\DATA. It uses
' the default setting and resets the instrument after storage
' of the setting.

'----- R&S ESCI default setting -----
-----
Call SetupInstrument
CALL IBWRT(receiver%,"INIT:CONT OFF")           'Single sweep
CALL IBWRT(receiver%,"INIT;*WAI")             'Perform sweep with sync

'----- Select items to be stored -----
CALL IBWRT(receiver%,"MMEM:SEL:HWS ON")        'Save hardware settings
CALL IBWRT(receiver%,"MMEM:SEL:TRAC OFF")      'No storing of traces
CALL IBWRT(receiver%,"MMEM:SEL:LIN:ALL OFF")  'Save only active limit lines

'----- Define comment -----
CALL IBWRT(receiver%,"MMEM:COMM 'Test Setup'")

'----- Store selected items -----
CALL IBWRT(receiver%,"MMEM:STOR:STAT 1,'D:\USER\DATA\TEST1'")

'----- Reset instrument -----
CALL IBWRT(receiver%,"*RST")

END SUB
REM *****

```

Loading Device Settings

In the following example, data set TEST1 stored under D:\USER\DATA is reloaded into the instrument:

```

REM *****
Public Sub LoadSettings()

  'This subroutine loads data set "TEST1" in directory D:\USER\DATA.
  '----- Default setting of status register -----
  Call SetupStatusReg           'Configure status register
  '----- Load data set -----
  CALL IBWRT(receiver%,"MMEM:LOAD:STAT 1,'D:\USER\DATA\TEST1'")
  '----Start measurement using the data set loaded -----
  CALL IBWRT(receiver%,"DISP:TRAC1:MODE WRITE") 'Set trace to Clr/Write
  CALL IBWRT(receiver%,"INIT;*WAI")           'Start the sweep
END SUB
REM *****

```

Setting the Data Set for Startup Recall

In the following example, the R&S ESCI is first reset. Then the data set TEST1 stored under D:\USER\DATA is selected for the STARTUP RECALL function, i.e. the data set is set for every *RST, PRESET and every device startup. For illustration, the command *RST is executed again.

```

REM *****
Public Sub StartupRecallSettings()
  '----- Reset R&S ESCI -----
  -----
  CALL IBWRT(receiver%,"*RST")
  '----- Default setting of status register -----
  Call SetupStatusReg           'Configure status register
  '----- Select startup recall data set-----
  CALL IBWRT(receiver%,"MMEM:LOAD:AUTO 1,'D:\USER\DATA\TEST1'")
  '----- Activate startup recall data set -----
  CALL IBWRT(receiver%,"*RST")
END SUB
REM *****

```

Reading and Writing Files

Reading a File from the Instrument

In the following example, file TEST1.SET stored under D:\USER\DATA is read from the instrument and stored in the controller.

```

REM *****
Public Sub ReadFile()
'----- Generate variables -----
Dim digits As Byte           'Number of digits of
                             'length information
Dim fileBytes As Long       'Length of file with trace data
                             'in bytes
result$ = Space$(100)       'Buffer for simple results
'----- Default setting of status register -----
Call SetupStatusReg         'Configure status register
'----- Read out file -----
Call ibwrt(receiver%, "MMEM:DATA? 'D:\USER\DATA\TEST1.SET'")
                             'Select file
Call ilrd(receiver%, result$, 2) 'Read and store number of
digits = Val(Mid$(result$, 2, 1)) 'digits of length information
Call ilrd(receiver%, result$, digits) 'Read and store length
fileBytes = Val(Left$(result$, digits)) 'information
FileBuffer$ = Space$(fileBytes) 'Buffer for file
Call ilrd(receiver%, FileBuffer, fileBytes) 'Read file into buffer
Call ilrd(receiver%, result$, 1) 'Read terminator <NL>
'----- Store file to controller -----
Open "TEST1.SET" For Output As #1
Print #1, FileBuffer;           ' ; to avoid linefeed at
                             ' end of file

Close #1
END SUB
REM *****

```

Creating a File on the Instrument

In the following example, the TEST1.SET file available on the controller is stored in the instrument under D:\USER\DATA\DUPLICAT.SET.

```

REM *****
Public Sub WriteFile()
  '----- Generate variables -----
  FileBuffer$ = Space$(100000)           'Buffer for file
  Dim digits As Long                    'Number of digits of
                                        'length information
  Dim fileBytes As Long                 'Length of file in bytes
  fileSize$ = Space$(100)              'Length of file as a string
  result$ = Space$(100)                'Buffer for simple results

  '----- Default setting of status register -----
  Call SetupStatusReg                   'Configure status register

  '----- Prepare the definite length block data -----
  fileBytes = FileLen("H:\work\vb\test1.set") 'Determine length of file
  fileSize$ = Str$(fileBytes)
  digits = Len(fileSize$) - 1           'Determine number of digits of
  fileSize$ = Right$(fileSize$, digits) 'length information
  FileBuffer$ = "#" + Right$(Str$(digits), 1) + fileSize$
                                        'Store length information in
                                        'file buffer

  '----- Read file from controller -----
  Open "H:\work\vb\TEST1.SET" For Binary As #1
  FileBuffer$ = FileBuffer$ + Left$(Input(fileBytes, #1), fileBytes)
  Close #1

  '----- Write file -----
  -
  Call ibwrt(receiver%, "SYST:COMM:GPIB:RTER EOI") 'Set receive
                                                    'terminator on the
                                                    'instrument

  Call ibwrt(receiver%, "MMEM:DATA 'D:\USER\DATA\DUPLICAT.SET', " +
                        FileBuffer$)              'Select file

END SUB
REM *****

```

Configuring and Starting a Printout

The following example shows the configuration of the output format and output device for printing out the measurement screen.

Proceed in the following order:

1. Set the measurement required for the printout
2. Query available output devices
3. Select an output device
4. Select the output interface
5. Configure the output format
6. Start printout with synchronization to the end

It is assumed that the setting required is a signal with a power of -20 dBm at 100 MHz and that the printer required is the No. 6 of the printers available. The data is first output on the selected printer, then to a file.

```

REM *****
Public Sub HCopy()

DIM Devices(100) as string           'Buffer for printer name
FOR i = 0 TO 49
    Devices$(i) = Space$(50)         'Preallocate buffer for
                                     'printer name
NEXT i

'----- R&S ESCI default setting -----
-----
CALL SetupStatusReg                 'Configure status register
CALL IBWRT(receiver%,"*RST")        'Reset instrument
CALL IBWRT(receiver%,"INIT:CONT OFF") 'Single sweep
CALL IBWRT(receiver%,"SYST:DISP:UPD ON") 'Display on

'----- Configure measurement -----
CALL IBWRT(receiver%,"FREQ:CENT 100MHz;SPAN 10MHz") 'Set frequency
CALL IBWRT(receiver%,"DISP:WIND:TRAC:Y:RLEV -10dBm") 'Reference level
CALL IBWRT(receiver%,"INIT;*WAI") 'Perform measurement

'----- Query regarding available output devices -----
CALL IBWRT(receiver%,"SYST:COMM:PRIN:ENUM:FIRSt?") 'Read out first output
CALL IBRD(receiver%,Devices$(0)) 'device and indicate
PRINT "Drucker 0: "+Devices$(0) 'name

For i = 1 to 99
    CALL IBWRT(receiver%,"SYST:COMM:PRIN:ENUM:NEXT?") 'Read out the next
    CALL IBRD(receiver%,Devices$(i)) 'printer name
    IF Left$(Devices$(i),2) = "" THEN GOTO SelectDevice 'Abort at end of
                                                         'list
    PRINT "Drucker"+Str$(i)+" : " Devices$(i) 'Indicate printer name
NEXT i

```

SelectDevice:

```
'----- Select device, printer language and output interface -----
CALL IBWRT(receiver%,"SYST:COMM:PRIN:SEL "+ Devices(6))'Select printer #6
8 CALL IBWRT(receiver%,"HCOP:DEST 'SYST:COMM:PRIN'") 'Configuration:
                                     '"Output to
                                     'printer interface"

CALL IBWRT(receiver%,"HCOP:DEV:LANG GDI")          'Output language 'GDI'
'----- Select orientation (portrait/landscape) and colour/BW -----
CALL IBWRT(receiver%,"HCOP:PAGE:ORI PORTRait")      'Portrait
CALL IBWRT(receiver%,"HCOP:DEV:COL OFF")           'Black and white
'----- Configure and start print out -----
CALL IBWRT (receiver%,"HCOP:ITEM:ALL")              'Select complete screen
'CALL IBWRT (receiver%,"HCOP:ITEM:WIND1:TRAC:STAT ON") 'alternative: only
'CALL IBWRT (receiver%,"HCOP:ITEM:WIND2:TRAC:STAT ON") 'traces in
                                                         'screen A/B

CALL IBWRT (receiver%,"*CLS")                       'Reset status registers
CALL IBWRT (receiver%,"HCOP:IMMediate;*OPC")        'Start print out

CALL WaitSRQ(boardID%,result%)                     'Wait for service request
IF (result% = 1) THEN CALL Srq                     'If SRQ is recognized =>
                                                         'Subroutine for evaluation

'----- Print out into file in WMF format (BMP format) -----
CALL IBWRT(receiver%,"HCOP:DEST 'MMEM'")            'Configuration:
                                                         '"Print to file"

CALL IBWRT(receiver%,"HCOP:DEV:LANG WMF")           'File format WMF
'CALL IBWRT(receiver%,"HCOP:DEV:LANG BMP")          'File format BMP

CALL IBWRT(receiver%,"MMEM:NAME 'D:\USER\DATA\PRINT1.WMF'") 'Determine
                                                         'file name

CALL IBWRT (receiver%,"*CLS")                       'Reset status registers
CALL IBWRT (receiver%,"HCOP:IMMediate;*OPC")        'Start print out

CALL WaitSRQ(boardID%,result%)                     'Wait for service request
IF (result% = 1) THEN CALL Srq                     'If SRQ is recognized =>
                                                         'Subroutines for evaluation

END SUB

REM *****
```

Contents - Chapter 8 "Maintenance and Instrument Interfaces"

8 Maintenance and Instrument Interfaces.....	8.1
Maintenance.....	8.1
Mechanical and Electrical Maintenance	8.1
Storing and Packing	8.1
List of Power Cables Available	8.1
Instrument Interfaces	8.2
AF Output	8.2
Probe Connector (PROBE POWER)	8.2
External Keyboard (KEYBOARD).....	8.2
IEC Bus Interface	8.3
Interface Characteristics	8.3
Bus Lines	8.3
Interface Functions	8.4
IEC Bus Messages	8.4
Interface Messages.....	8.5
Instrument Messages.....	8.5
Printer Interface (LPT).....	8.6
RS-232-C Interface (COM)	8.7
Interface Characteristics	8.7
Signal Lines.....	8.7
Transmission Parameters.....	8.8
Control Characters.....	8.9
Handshake.....	8.9
User Interface (USER)	8.10
Monitor Connector (MONITOR)	8.11
Noise Source Control (NOISE SOURCE)	8.11
External Trigger Input (EXT TRIG/GATE).....	8.11
Mouse Connector (MOUSE)	8.11
USB Connector (USB 	8.12
Reference Output/Input (REF IN and REF OUT).....	8.12
IF Output 20.4 MHz (20.4 MHz OUT).....	8.12
Input for External Modulation of Tracking Generator	8.12
IEC 2 Interface (Option FSP-B10).....	8.13
AUX CONTROL Interface (Option FSP-B10).....	8.13
LAN Interface	8.13

8 Maintenance and Instrument Interfaces

The R&S ESCI following chapter contains information on the maintenance of the R&S ESCI and on the instrument interfaces.

Please follow the instructions in the service manual when exchanging modules or ordering spares. The order no. for spare parts can be found in the service manual.

The address of our support center and a list of all Rohde & Schwarz service centers can be found at the beginning of this manual.

The service manual includes further information particularly on troubleshooting, repair, exchange of modules (including battery exchange, adjustment of the OCXO oscillator) and calibration.

Maintenance

Mechanical and Electrical Maintenance

The R&S ESCI does not require any special maintenance. Remove any contamination on the instrument by means of a soft cloth. Make sure that the air vents are not obstructed.

Storing and Packing

The R&S ESCI can be stored at a temperature of -5°C to $+60^{\circ}\text{C}$. When stored for an extended period of time the instrument should be protected against dust.

The original packing should be used, particularly the protective covers at the front and rear, when the instrument is to be transported or dispatched. If the original packing is no longer available, use a sturdy cardboard box of suitable size and carefully wrap the instrument to protect it against mechanical damage.

List of Power Cables Available

Table 8-1 List of power cables available

Stock No.	Earthed-contact connector	Preferably used in
DS 006.7013	BS1363: 1967' complying with IEC 83: 1975 standard B2	Great Britain
DS 006.7020	Type 12 complying with SEV-regulation 1011.1059, standard sheet S 24 507	Switzerland
DS 006.7036	Type 498/13 complying with US-regulation UL 498, or with IEC 83	USA/Canada
DS 006.7107	Type SAA3 10 A, 250 V, complying with AS C112-1964 Ap.	Australia
DS 0025.2365 DS 0099.1456	DIN 49 441, 10 A, 250 V, angular DIN 49 441, 10 A, 250 V, straight	Europe (except Switzerland)

Instrument Interfaces

AF Output



A miniature telephone jack can be used at the AF OUTPUT connector to connect an external loudspeaker, a headphone set or, e.g., a LF voltmeter. The internal resistance is 10 ohms and the output voltage can be controlled with the volume controller on the left side to the connector. When a jack is plugged in, the internal loudspeaker is automatically turned off.

Probe Connector (PROBE POWER)

To allow the connection of probes, the R&S ESCI provides the PROBE POWER power connectors. The 3-pole connector delivers the power supply voltages +15 V and -12,6 V and ground.

The connector is also suited for powering the high-impedance probes from Hewlett Packard.

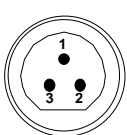

Pin	Signal
1	GND
2	-12.6 V; max 150 mA
3	+15 V; max 150 mA

Fig. 8-1 Pin assignments of PROBE POWER connector

To allow the connection of R&S accessories, the R&S ESCI also offers the 5-pole PROBE POWER connector which delivers the power supply voltages ±10 V and ground. An adapter to connect a 12-pin Tuchel connector is provided with the instrument.



Pin	Signal
1	GND
2	-10 V, max. 200 mA
3	-
4	+10 V, max. 200 mA
5	-

Fig. 8-2 Pin assignments of PROBE POWER connector

External Keyboard (KEYBOARD)

A 6-pin PS/2 connector is provided on the front panel to allow connecting an external keyboard. The PSP-Z1 keyboard (Order No. 1091.4000.02, German) or the PSP-Z2 (Order No. 1091.4100.02, English) is recommended (Order No. 1009.5001.31). Also they include a trackball for mouse control. However, any other multifunction keyboard may also be used.

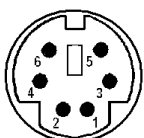

Pin	Signal	Pin	Signal
1	KEYBOARDDATA	4	5V, KEYBOARD
2	MOUSEDATA	5	KEYBOARDCLK
3	GND	6	MOUSECLK

Fig 8-2 Pin assignments of the KEYBOARD connector.

IEC Bus Interface

The standard instrument is equipped with an IEC/IEEE Bus connector. An IEEE 488 interface connector is located on the rear panel of the R&S ESCI. An external controller for remote control of the instrument can be connected via the IEEE 488 interface connector using a shielded cable.

Interface Characteristics

- 8-bit parallel data transfer
- bi-directional data transfer
- three-line handshake
- high data transfer rate of max. 350 kbyte/s
- up to 15 instruments can be connected
- maximal length of the interconnecting cables 15 m (single connection, 2m)
- wired-OR connection if several instruments are connected in parallel.

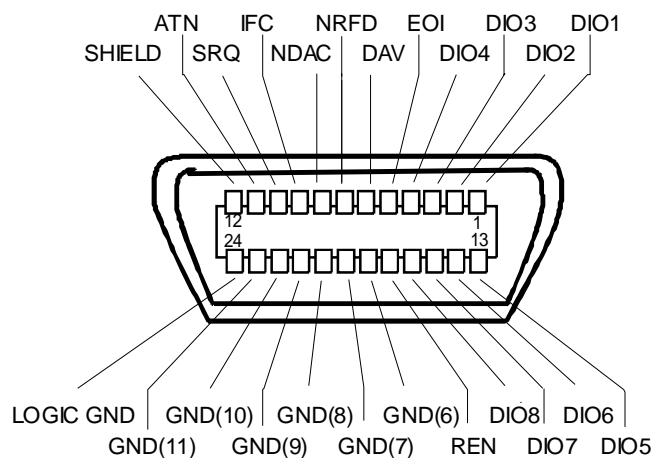

Fig. 8-3 Pin assignment of IEC-Bus interface

Bus Lines

1. Data bus with 8 lines DIO 1 to DIO 8.

The transmission is bit-parallel and byte-serial in the ASCII/ISO code. DIO1 is the least significant, DIO8 the most significant bit.

2. Control bus with 5 lines.

IFC (Interface Clear),

active low resets the interfaces of the devices connected to the default setting.

ATN (Attention),

active low signals the transmission of interface messages

inactive high signals the transmission of device messages.

SRQ (Service Request),

active low enables a device connected to send a service request to the controller.

REN (Remote Enable),

active low permits the switch over to remote control.

EOI (End or Identify),

has two functions in connection with ATN:

active low marks the end of data transmission when ATN=high

active low triggers a parallel poll when ATN=low.

3. Handshake bus with three lines.

DAV (Data Valid),

active low signals a valid data byte on the data bus.

NRFD (Not Ready For Data),

active low signals that one of the devices connected is not ready for data transfer .

NDAC (Not Data Accepted),

active low as long as the device connected is accepting the data present on the data bus.

Interface Functions

Instruments which can be remote controlled via the IEC bus can be equipped with different interface functions. Table 8-2 lists the interface functions appropriate for the instrument.

Table 8-2 Interface functions

Control character	Interface function
SH1	Handshake source function (source handshake), full capability
AH1	Handshake sink function (acceptor handshake), full capability
L4	Listener function, full capability, unaddress if MTA.
T6	Talker function, full capability, ability to respond to serial poll, unaddress if MLA
SR1	Service request function (Service Request), full capability
PP1	Parallel poll function, full capability
RL1	Remote/Local switch over function, full capability
DC1	Reset function (Device Clear), full capability
DT1	Trigger function (Device Trigger), full capability
C0	No controller function

IEC Bus Messages

The messages transferred via the data lines of the IEC bus can be divided into two groups:

- **interface messages** and
- **instrument messages.**

Interface Messages

Interface messages are transferred on the data lines of the IEC Bus when the "ATN" control line is active (LOW). They are used for communication between controller and instruments and can only be sent by the controller which currently has control of the IEC Bus.

Universal Commands

The universal commands are encoded 10 - 1F hex. They affect all instruments connected to the bus without addressing.

Table 8-3 Universal Commands

Command	QuickBASIC command	Effect on the instrument
DCL (Device Clear)	IBCMD (controller%, CHR\$(20))	Aborts the processing of the commands just received and sets the command processing software to a defined initial state. Does not change the instrument settings.
IFC (Interface Clear)	IBSIC (controller%)	Resets the interfaces to the default setting.
LLO (Local Lockout)	IBCMD (controller%, CHR\$(17))	The LOC/IEC ADDR key is disabled.
SPE (Serial Poll Enable)	IBCMD (controller%, CHR\$(24))	Ready for serial poll.
SPD (Serial Poll Disable)	IBCMD (controller%, CHR\$(25))	End of serial poll.
PPU (Parallel Poll Unconfigure)	IBCMD (controller%, CHR\$(21))	End of the parallel-poll state.

Addressed Commands

The addressed commands are encoded 00 - 0F hex. They are only effective for instruments addressed as listeners.

Table 8-4 Addressed Commands

Command	QuickBASIC command	Effect on the instrument
SDC (Selected Device Clear)	IBCLR (device%)	Aborts the processing of the commands just received and sets the command processing software to a defined initial state. Does not change the instrument setting.
GTL (Go to Local)	IBLOC (device%)	Transition to the "Local" state (manual control).
PPC (Parallel Poll Configure)	IBPPC (device%, data%)	Configure instrument for parallel poll. Additionally, the QuickBASIC command executes PPE/PPD.

Instrument Messages

Instrument messages are transferred on the data lines of the IEC bus when the "ATN" control line is not active. ASCII code is used.

Structure and syntax of the instrument messages are described in Chapter 5. The commands are listed and explained in detail in Chapter 6.

Printer Interface (LPT)

The 25-pin LPT connector on the rear panel of the Fig. 8-4 is provided for the connection of a printer. The LPT interface is compatible with the CENTRONICS printer interface.

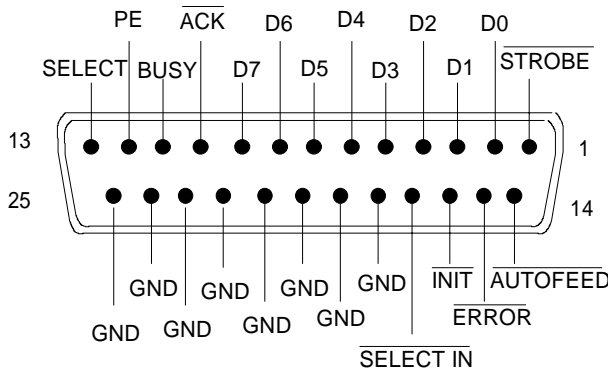

Pin	Signal	Input (I) Output (O)	Description
1	STROBE	O	Pulse for transmitting a data byte, min. 1µs pulse width (active LOW)
2	D0	O	Data Line 0
3	D1	O	Data Line 1
4	D2	O	Data Line 2
5	D3	O	Data Line 3
6	D4	O	Data Line 4
7	D5	O	Data Line 5
8	D6	O	Data Line 6
9	D7	O	Data Line 7
10	ACK	I	Indicates that the printer is ready to receive the next byte. (active LOW)
11	BUSY	I	Signal is active when the printer cannot accept data. (active HIGH)
12	PE	I	Signal is active when the paper tray is empty. (active HIGH)
13	SELECT	I	Signal is active when the printer is selected. (active HIGH)
14	AUTOFEED	O	When signal is active, the printer automatically performs a linefeed after each line. (active LOW)
15	ERROR	I	This signal is high when the printer has no paper, is not selected or has an error status. (active LOW)
16	INIT	O	Initialize the printer. (active LOW)
17	SELECT IN	O	If signal is active, the codes DC1/DC3 are ignored by the printer. (active LOW).
18 - 25	GND		Ground connection.

Fig. 8-4 Pin assignments for the LPT connector.

RS-232-C Interface (COM)

The standard R&S ESCI is equipped with a serial interfaces (RS-232-C; COM connector at the rear of the instrument). The interface can be set up and activated manually in the *SETUP-GENERAL SETUP* menu in the *COM PORT* table (Selection *OWNER = INSTRUMENT*).

Interface Characteristics

- Serial data transmission in asynchronous mode
- Bi-directional data transfer via two separate lines
- Transmission rate selectable from 110 to 19200 baud
- Logic '0' signal from +3 V to +15 V
- Logic '1' signal from -15 V to -3 V
- An external instrument (controller) can be connected.

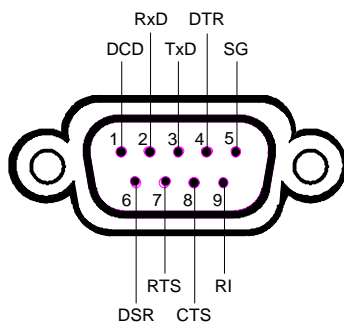

Fig. 8-5 Pin assignment of the RS-232-C interface

Signal Lines

DCD (Data Carrier Detect),

Not used in R&S ESCI.

Input; active LOW.

Using this signal, the local terminal recognizes that the modem of the remote station receives valid signals with sufficient level. DCD is used to disable the receiver in the local terminal and prevent reading of false data if the modem cannot interpret the signals of the remote station.

RxD (Receive Data)

Input, LOW = logic '1', HIGH = logic '0'.

Data line, local terminal receives data from remote station.

TxD (Transmit Data)

Output, LOW = logic '1', HIGH = logic '0'.

Data line, local terminal transmits data to remote station.

DTR (Data Terminal Ready),

Output, active LOW,

Indicates that the local terminal is ready to receive data.

GND

Interface ground, connected to instrument ground

DSR (Data Set Ready),
Input, active LOW,
Indicates that the remote station is ready to receive data.

RTS (Request To Send),
Output, active LOW.
Indicates that the local terminal wants to transmit data.

CTS (Clear To Send),
Input, active LOW.
Used to tell the local terminal that the remote station is ready to receive data.

RI (Ring Indicator),
Not used in R&S ESCI.
Input, active LOW.
Used by a modem to indicate that a remote station wants to establish a connection.

Transmission Parameters

To ensure error-free data transmission, the parameters of the instrument and the controller must have the same settings. The parameters are defined in the *SETUP-GENERAL SETUP* menu.

Transmission rate (baud rate) the following transmission rates can be set in the instrument:
110, 300, 600, 1200, 2400, 4800, 9600, 19200.

Data bits Data transmission is in 7- or 8-bit ASCII code. The first bit transmitted is the LSB (least significant bit).

Start bit Each data byte starts with a start bit. The falling edge of the start bit indicates the beginning of the data byte.

Parity bit In order to detect errors, a parity bit may be transmitted. No parity, even parity or odd parity may be selected. In addition, the parity bit can be set to logic '0' or to logic '1'.

Stop bits The transmission of a data byte is terminated by 1, 1,5 or 2 stop bits.

Example:

Transmission of character 'A' (41 hex) in 7-bit ASCII code,
with even parity and 2 stop bits:

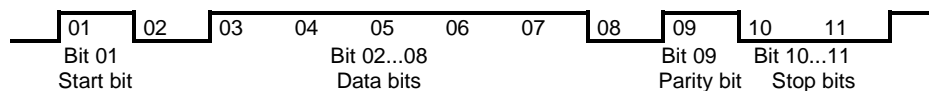

Control Characters

For interface control, several strings are defined and control characters are reserved which are based upon IEC Bus control.

Table 8-5 Control strings or control characters of the RS-232 interface

Control string or character	Function
'@REM'	Switch over to remote
'@LOC'	Switch over to local
'@SRQ'	Service Request SRQ (SRQ is sent by the instrument)
'@GET'	Group Execute Trigger (GET)
'@DCL'	Reset instrument (Device Clear DCL)
<Ctrl Q> 11 Hex	Enables character output / XON
<Ctrl S> 13 Hex	Inhibits character output / XOFF
0D Hex, 0A Hex	Terminator <CR>, <LF>

Handshake

Software handshake

In the software handshake mode of operation, the data transfer is controlled using the two control characters XON / XOFF.

The instrument uses the control character XON to indicate that it is ready to receive data. If the receive buffer is full, it sends the XOFF character via the interface to the controller. The controller then interrupts the data output until it receives another XON from the instrument. The controller indicates to the instrument that it is ready to receive data in the same way.

Cable required for software handshake

The connection of the instrument with a controller for software handshake is made by crossing the data lines. The following wiring diagram applies to a controller with a 9-pin or 25-pin configuration.

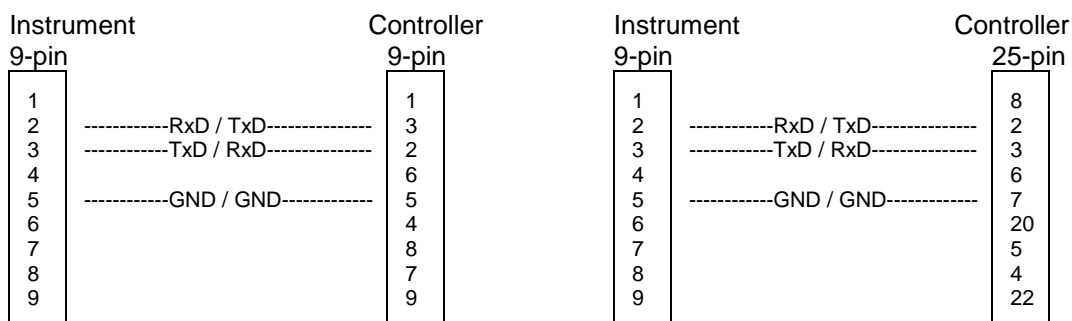

Fig. 8-6 Wiring of the data lines for software handshake

Hardware handshake

For hardware handshake, the instrument indicates that it is ready to receive data via the lines DTR and RTS. A logic '0' on both lines means 'ready' and a logic '1' means 'not ready'. The RTS line is always active (logic '0') as long as the serial interface is switched on. The DTR line thus controls the readiness of the instrument to receive data.

The readiness of the remote station to receive data is reported to the instrument via the CTS and DSR line. A logic '0' on both lines activates the data output and a logic '1' on both lines stops the data output of the instrument. The data output takes place via the TxD line.

Cable for hardware handshake

The connection of the instrument to a controller is made with a so-called zero modem cable. Here, the data, control and acknowledge lines must be crossed. The following wiring diagram applies to a controller with a 9-pin or 25-pin configuration.

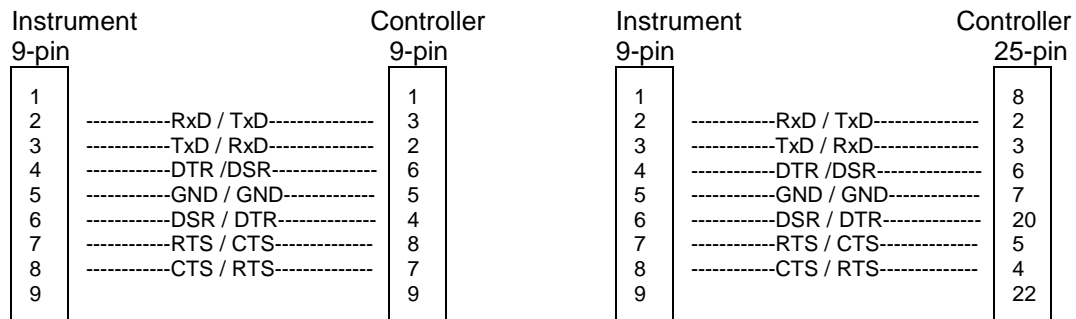

Fig. 8-7 Wiring of the data, control and acknowledge lines for hardware handshake

User Interface (USER)

The user interface, located on the rear panel of the , is a 25 pin Cannon connector which provides access to the user ports (Port A). The port is 8 bits wide (A0 - A7) and can be configured either as output or as input. The voltage levels are TTL levels (Low < 0,4 V, High > 2 V).

In addition, an internal +5 V power supply voltage is provided. The maximum load current is 100 mA. The pin assignments for the USER connector can be seen in the following diagram:

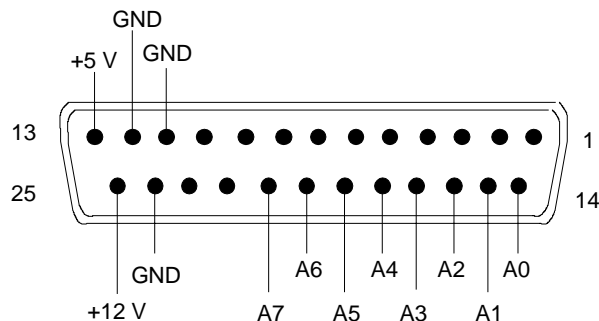

Fig. 8-9 Pin assignments for the USER connector.

The configuration of the user ports takes place in the *SETUP* menu (SETUP key) in the *GENERAL SETUP* sub-menu.

Monitor Connector (MONITOR)

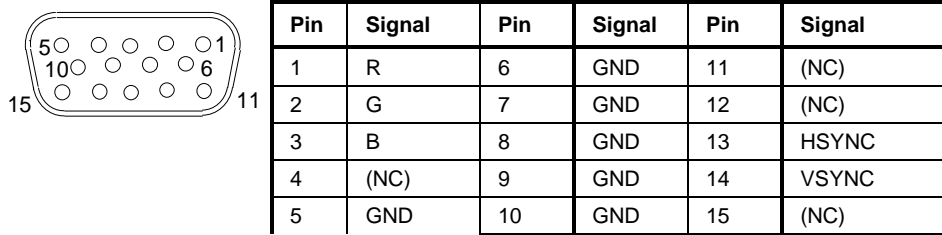

Fig. 8-8 Pin assignments of the MONITOR connector.

Noise Source Control (NOISE SOURCE)

Using the NOISE SOURCE connector, an external noise source can be switched on/off, in order, e.g., to measure the noise figure of units under test (UUTs). Usual noise sources require a +28 V signal to be turned on. At 0 V, they are turned off. These supply voltages are delivered by the connector. Maximum current is 100 mA..

External Trigger Input (EXT TRIG/GATE)

The EXT TRIG/GATE connector is used for controlling the measurement via an external signal. The trigger voltages are TTL level (Low < 0.7 V, High > 1.4 V), typ. input impedance is 10 kOhm.

Mouse Connector (MOUSE)

A PS/2 connector is provided at the rear panel to connect a PS/2 mouse:

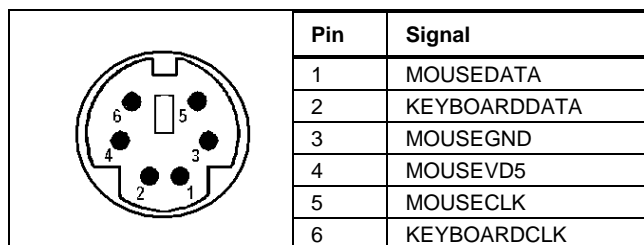

Fig 8-9 Pin assignments for the MOUSE connector.

USB Connector (USB)

A USB connector is provided at the rear panel of the R&S FSP. This USB connector is used to connect two USB devices (USB 1.1):

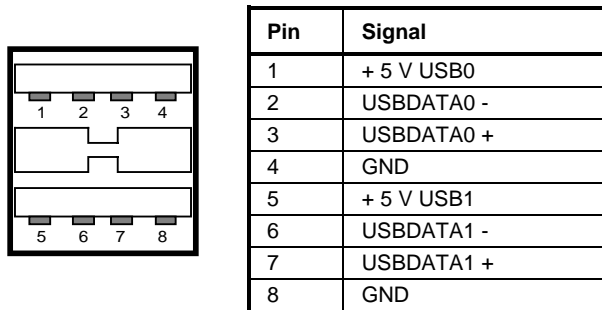

Fig. 8-10 USB connector assignment

Note: *Passive USB connection cables should not be longer than 1 m.*

Reference Output/Input (REF IN and REF OUT)

For operation with an external reference, the internal reference oscillator is then synchronized to the 10-MHz reference applied to the connector. The necessary level is > 0 dBm.

The internal 10 MHz reference signal is also available at the REF OUT connector and thus provides the capability of, e.g., synchronization of external instruments to the R&S ESCI. The output level is 0 dBm.

Selection between internal and external reference is possible in the *SETUP* menu.

IF Output 20.4 MHz (20.4 MHz OUT)

The 20.4 MHz IF signal of the R&S ESCI is available at the 20.4 MHz OUT BNC connector. The bandwidth corresponds to the selected bandwidth for a resolution bandwidth between 100 kHz and 10 MHz. For a resolution bandwidth below 100 kHz, the bandwidth of the output is 2.6 times the resolution bandwidth with a minimum of 2.6 kHz.

The signal level at the IF output is 0 dBm for resolution bandwidth \geq 100 kHz, and -10 dBm for resolution bandwidth < 100 kHz (mixer level \geq 60 dBm) .

Input for External Modulation of Tracking Generator (TG I /AM IN; TG Q / FM IN) (Option FSP-B9)

Connectors TG I /AM IN and TG Q /FM IN are provided for external modulation of the tracking generator. The input voltage range is $\pm 0,5$ V. input impedance is 50 Ohm.

CCVS Input and Output (CCVS IN/OUT, Option FSP-B6)

The BNC connector CCVS IN/OUT can be switched at CCVS input or CCVS output. If TV triggering is switched on, the demodulated TV signal is available for operating a CCVS monitor, provided triggering is set to the internal demodulation signal (CCVS INT). In case of TV triggering to an externally fed CCVS signal (CCVS EXT), the connector serves as an input.

IEC 2 Interface (Option FSP-B10)

The IEC 2 interface is available as an option for the IEC bus of the signal generator.

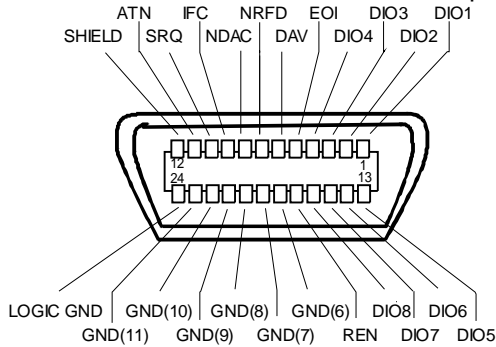

Fig. 8-11 Pin assignment of IEC 2 interface

AUX CONTROL Interface (Option FSP-B10)

The optional AUX CONTROL interface is associated with the option FSP-B10 (External Generator Control). It allows fast frequency switching with the external generator control option when a Rohde & Schwarz signal generator is used.

The cable supplied is used to connect the interface to the corresponding interface of the signal generator (see also section " External Generator Control Option - FSP-B10). The voltage levels are of the TTL type (low < 0.4 V, high > 2 V).

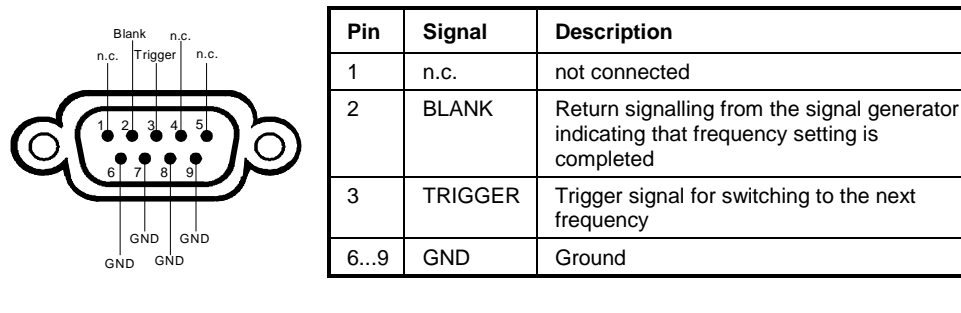

Fig. 8-12 Pin assignment of AUX CONTROL connector

LAN Interface

The option FSP-B16 - LAN interface allows the instrument to be connected to local networks. The pin assignment of the RJ45 connector supports double-paired category 5 UTP/STP cables in star configuration. (UTP means unshielded twisted pair, and STP stands for shielded twisted pair).

Contents - Chapter 9 "Error Messages"

9 Error Messages

SCPI-Specific Error Messages	9.2
Device-Specific Messages.....	9.8

9 Error Messages

Error messages are entered in the error/event queue of the status reporting system in the remote control mode and can be queried with the command `SYSTem:ERRor?`. The answer format of R&S ESCI to the command is as follows:

```
<error code>, "<error text with queue query>;  
<remote control command concerned>"
```

The indication of the remote control command with prefixed semicolon is optional.

Example:

The command "`TEST:COMMAND`" generates the following answer to the query `SYSTem:ERRor?` :

```
-113,"Undefined header;TEST:COMMAND"
```

The subsequent list contains the description of error texts displayed on the instrument.

Distinction is made between error messages defined by SCPI, which are marked by negative error codes, and the device-specific error messages for which positive error codes are used.

The right-hand column in the following tables contains the error text in bold which is entered in the error/event queue and can be read out by means of query `SYSTem:ERRor?`. A short explanation of the error cause is given below. The left-hand column contains the associated error code.

SCPI-Specific Error Messages

No Error

Error code	Error text in the case of queue poll Error explanation
0	No error This message is output if the error queue does not contain any entries.

Command Error - Faulty command; sets bit 5 in the ESR register.

Error code	Error text in the case of queue poll Error explanation
-100	Command Error The command is faulty or invalid.
-101	Invalid Character The command contains an invalid sign. Example: A header contains an ampersand, " SENSe& ".
-102	Syntax error The command is invalid. Example: The command contains block data the instrument does not accept.
-103	Invalid separator The command contains an imallowed sign instead of a separator. Example: A semicolon is missing after the command.
-104	Data type error The command contains an invalid value indication. Example: ON is indicated instead of a numeric value for frequency setting.
-105	GET not allowed A Group Execute Trigger (GET) is within a command line.
-108	Parameter not allowed The command contains too many parameters. Example: Command SENSe:FREQuency:CENTer permits only one frequency indication.

Continuation: Command Error

Error code	Error text in the case of queue poll Error explanation
-109	Missing parameter The command contains too few parameters. Example: The command <code>SENSe:FREQuency:CENTer</code> requires a frequency indication.
-110	Command header error The header of the command is faulty.
-111	Header separator error The header contains an imallowed separator. Example: the header is not followed by a "White Space", " <code>*ESE255</code> "
-112	Program mnemonic too long The header contains more than 12 characters.
-113	Undefined header The header is not defined for the instrument. Example: <code>*XYZ</code> is undefined for every instrument.
-114	Header suffix out of range The header contains an imallowed numeric suffix. Example: <code>SENSe3</code> does not exist in the instrument.
-120	Numeric data error The command contains a faulty numeric parameter.
-121	Invalid character in number A number contains an invalid character. Example: An "A" in a decimal number or a "9" in an octal number.
-123	Exponent too large The absolute value of the exponent is greater than 32000.
-124	Too many digits The number includes too many digits.
-128	Numeric data not allowed The command includes a number which is not allowed at this position. Example: The command <code>INPut:COUPLing</code> requires indication of a text parameter.
-130	Suffix error The command contains a faulty suffix.
-131	Invalid suffix The suffix is invalid for this instrument. Example: nHz is not defined.
-134	Suffix too long The suffix contains more than 12 characters.
-138	Suffix not allowed A suffix is not allowed for this command or at this position of the command. Example: The command <code>*RCL</code> does not permit a suffix to be indicated.
-140	Character data error The command contains a faulty text parameter
-141	Invalid character data The text parameter either contains an invalid character or it is invalid for this command. Example: Write error with parameter indication; <code>INPut:COUPLing XC</code> .

Continuation: Command Error

Error code	Error text in the case of queue poll Error explanation
-144	Character data too long The text parameter contains more than 12 characters.
-148	Character data not allowed The text parameter is not allowed for this command or at this position of the command. Example: The command *RCL requires a number to be indicated.
-150	String data error The command contains a faulty string.
-151	Invalid string data The command contains a faulty string. Example: An END message has been received prior to the terminating apostrophe.
-158	String data not allowed The command contains a valid string at a position which is not allowed. Example: A text parameter is set in quotation marks, INPut:COUPLing "DC"
-160	Block data error The command contains faulty block data.
-161	Invalid block data The command contains faulty block data. Example: An END message was received prior to reception of the expected number of data.
-168	Block data not allowed The command contains valid block data at an imallowed position. Example: The command *RCL requires a number to be indicated.
-170	Expression error The command contains an invalid mathematical expression.
-171	Invalid expression The command contains an invalid mathematical expression. Example: The expression contains mismatching parentheses.
-178	Expression data not allowed The command contains a mathematical expression at an imallowed position.

Execution Error - Error on execution of a command; sets bit 4 in the ESR register

Error code	Error text in the case of queue poll Error explanation
-200	Execution error Error on execution of the command.
-201	Invalid while in local The command is not executable while the device is in local due to a hard local control. Example: The device receives a command which would change the rotary knob state, but the device is in local so the command can not be executed.
-202	Settings lost due to rtl A setting associated with hard local control was lost when the device changed to LOCS from REMS or to LWLS from RWLS.
-210	Trigger error Error on triggering the device.
-211	Trigger ignored The trigger (GET, *TRG or trigger signal) was ignored because of device timing considerations. Example: The device was not ready to respond.
-212	Arm ignored An arming signal was ignored by the device.
-213	Init ignored Measurement initialisation was ignored as another measurement was already in progress.
-214	Trigger deadlock The trigger source for the initiation of measurement is set to GET and subsequent measurement is received. The measurement cannot be started until a GET is received, but the GET would cause an interrupted-error)
-215	Arm deadlock The trigger source for the initiation of measurement is set to GET and subsequent measurement is received. The measurement cannot be started until a GET is received, but the GET would cause an interrupted-error.
-220	Parameter error The command contains a faulty or invalid parameter.
-221	Settings conflict There is a conflict between setting of parameter value and instrument state.
-222	Data out of range The parameter value lies out of the allowed range of the instrument.
-223	Too much data The command contains too many data. Example: The instrument does not have sufficient storage space.
-224	Illegal parameter value The parameter value is invalid. Example: The text parameter is invalid , TRIGger : SWEEp : SOURce TASTE

Continuation: Execution Error

Error code	Error text in the case of queue poll Error explanation
-230	Data corrupt or stale The data are incomplete or invalid. Example: The instrument has aborted a measurement.
-231	Data questionable The measurement accuracy is suspect.
-240	Hardware error The command cannot be executed due to problems with the instrument hardware.
-241	Hardware missing Hardware is missing. Example: An option is not fitted.
-250	Mass storage error A mass storage error occurred.
-251	Missing mass storage The mass storage is missing. Example: An option is not installed.
-252	Missing media The media is missing. Example: There is no floppy in the floppy disk drive.
-253	Corrupt media The media is corrupt. Example: The floppy is bad or has the wrong format.
-254	Media full The media is full. Example: There is no room on the floppy.
-255	Directory full The media directory is full.
-256	File name not found The file name cannot be found on the media.
-257	File name error The file name is wrong. Example: An attempt is made to copy to a duplicate file name.
-258	Media protected The media is protected. Example: The write-protect tab on the floppy is present.
-260	Expression error The expression contains an error.

Device Specific Error; sets bit 3 in the ESR register

Error code	Error test in the case of queue poll Error explanation
-300	Device-specific error R&S ESCI-specific error not defined in greater detail.
-310	System error This error message suggests an error within the instrument. Please inform the R&S Service.
-313	Calibration memory lost Loss of the non-volatile data stored using the *CAL? command. This error occurs when the correction data recording has failed.
-330	Self-test failed The selftest could not be executed.
-350	Queue overflow This error code is entered in the queue instead of the actual error code if the queue is full. It indicates that an error has occurred but not been accepted. The queue can accept 5 entries.

Query Error - Error in data request; sets bit 2 in the ESR register

Error code	Error text in the case of queue poll Error explanation
-400	Query error General error occurring when data are requested by a query.
-410	Query INTERRUPTED The query has been interrupted. Example: After a query, the instrument receives new data before the response has been sent completely.
-420	Query UNTERMINATED The query is incomplete. Example: The instrument is addressed as a talker and receives incomplete data.
-430	Query DEADLOCKED The query cannot be processed. Example: The input and output buffers are full, the instrument cannot continue operation.
-440	Query UNTERMINATED after indefinite response A query is in the same command line after a query which requests an indefinite response.

Device-Specific Messages

Error code	Error text in the case of queue poll Error explanation
1036	MS: The correction table based amplifier gain exceeds the amplifier range for CALAMP1 and CALAMP2 on IF board This message is output when the setting range of the calibration amplifier is not sufficient for the required correction. The error occurs only with modules which are not correctly adjusted or defective.
1052	Frontend LO is Unlocked This message is output when the phase regulation of the local oscillator fails in the RF frontend.
1060	Trigger-Block Gate Delay Error- gate length < Gate Delay This message is output when the gate signal length is not sufficient for the pull-in delay with a predefined gate delay.
1064	Tracking LO is Unlocked This message is output when the phase regulation of the local oscillator fails on the tracking generator module.

Error code	Error text in the case of queue poll Error explanation
2022	OPTIONS.INI invalid This message is output when an error has been recognized in the file OPTIONS.INI which contains the clearing codes for retrofitable firmware applications. If this file is not correctly recognized, all firmware applications are blocked for this instrument.
2028	Hardcopy not possible during measurement sequence This message is output when a printout is started during scan sequences that cannot be interrupted. Such sequences are for example: <ul style="list-style-type: none"> • Recording the system error correction data (calibration) • Instrument selftest In such cases a synchronization to the end of the scan sequence should be performed prior to starting the printout.
2033	Printer Not Available This message is output when the selected printer is not included in the list of available output devices. A possible cause is that the required printer driver is missing or incorrectly installed.
2034	CPU Temperature is too high This message is output when the temperature of the processor exceeds 70 °C.

10 Index

Note: All softkeys are listed alphabetically under keyword "Softkey" with their names. The page numbers 4.xxx refer to the detailed description of the softkeys in chapter 4. Generally, the number of the page in chapter 6 containing the equivalent remote control command is given in addition. A list of softkeys and equivalent remote control commands or command sequences is given in chapter 6, section "Table of Softkeys with IEC/IEEE-Bus Command Assignment". Chapter 6 also contains an alphabetical list of all remote control commands.

*		
* (enhancement label)	3.7
* (enhancement lable)	4.106
0		
0 to 9 (key)	3.13
1		
1 - 2 (trace info)	4.116
1 - 3 (trace info)	4.116
10 dB setting	4.10
2		
20.4 MHz Out	8.12
3		
3 dB bandwidths	4.12
6		
6 dB bandwidths	4.12
7		
75 Ω (enhancement lable)	3.7
A		
Abort recording of correction data	4.118
AC supply connection	1.14
ACP measurement	4.151
Addressed command	8.5
Adjacent-channel power		
number of channels	4.158
Administrator function	1.17
AF demodulation	4.135
AF OUTPUT	8.2
AM demodulation	4.22, 4.136
AM modulation	4.285
AM modulation depth	4.178
Amplitude	4.76
Amplitude probability distribution function	4.172
Amplitude statistics	4.170
Analyzer mode	4.69
Annotation	4.200
AP (trace info)	3.6
APD function	4.172
Ascii #	5.14
ASCII file export		
final measurement data	4.27
scan data	4.66
Attenuation	4.9, 4.78
Autoppeak detector	4.113
AUX CONTROL interface	8.13
AUX CONTROL connector	8.13
AV (trace info)	3.6
Average detector	4.17, 4.18, 4.112, 4.115
Averaging	4.105, 4.149
continuous sweep	4.105
lin/log	4.107
single sweep	4.105
sweep count	4.105
AVG (trace info)	3.6
Axis adjustment	4.50
B		
BACK (key)	3.13
Band filter, digital	4.14, 4.86
Bandwidth		
occupied	4.167
resolution	4.82
video	4.82
Baud rate	4.223
Block data	5.14
Boolean parameter	5.13
Brightness	4.202
Brightness, Screen	4.261
C		
Cables EZ-xx	4.41
Calibration		
functioning	4.282, 4.297
reflection measurement	4.296
reflexion measurement	4.281
transmission measurement	4.275, 4.290

- Calibration results 4.118
 - CANCEL (key)..... 3.13
 - CCDF function..... 4.172
 - CCIR 473-4 4.101
 - CCVS signal..... 4.102
 - Center frequency..... 4.70
 - step size..... 4.70
 - Channel
 - power..... 4.161
 - bandwidth 4.159, 4.167, 4.177
 - number..... 4.158
 - spacing 4.160
 - Channel filters 4.15, 4.88
 - Channel power measurement..... 4.153
 - Characters, special 6.2
 - CISPR AVERAGE..... 6.165
 - CISPR average detector 4.17
 - Clear/Write mode 4.63, 4.104
 - CLWR (trace info) 3.6
 - Colon..... 5.14
 - Color 4.202, 4.260
 - Color printout..... 4.260
 - COM interface..... 4.223, 8.7
 - Comma 4.27, 5.14
 - Command
 - #..... 5.14
 - addressed 8.5
 - colon 5.14
 - comma 5.14
 - description 6.1
 - hp compatibility..... 6.251
 - line 5.11
 - long form..... 5.10
 - overlapping execution 5.17
 - programming examples 7.1
 - query..... 5.12
 - question mark 5.12, 5.14
 - quotation mark 5.14
 - recognition 5.16
 - sequence 5.17
 - short form..... 5.10
 - structure..... 5.8
 - suffix 5.10
 - syntax elements..... 5.14
 - universal 8.5
 - white space..... 5.14
 - Common commands 6.4
 - CONDition register part 5.19
 - Configuration..... 4.203
 - save 4.238
 - Connection cables..... 4.41
 - Continue single sweep 4.91
 - Continuous sweep..... 4.90
 - Control
 - output level 4.274
 - Control characters..... 8.9
 - Copy
 - file..... 4.252
 - limit line..... 4.186
 - trace..... 4.68, 4.110
 - Correction
 - inherent noise 4.155
 - Correction data..... 4.117
 - Correction of entry..... 3.19
 - Correction values
 - normalization..... 4.272, 4.287
 - Counter resolution..... 4.123
 - Coupling
 - bandwidths..... 4.80
 - default settings..... 4.84, 4.86
 - frequency of diagrams..... 4.199
 - IF bandwidth to frequency range..... 4.14, 4.19
 - reference level of diagrams..... 4.199
 - resolution bandwidth..... 4.83
 - sweep time 4.84
 - video bandwidth..... 4.83
 - Create directory 4.251
 - Cumulative distribution function 4.172
- ## D
- Data reduction 4.23
 - Date..... 4.200
 - input 4.226
 - DCL 5.16
 - Decimal point..... 3.13
 - Decimal separator..... 4.27
 - Default
 - coupling ratios 4.84
 - display settings..... 4.201
 - scalings of x- and y-axis 4.174
 - scan table..... 4.44
 - Delay, gate signal 4.98
 - Delete
 - file..... 4.252
 - limit line 4.186
 - line of peak list..... 4.26
 - line of transducer table 4.215
 - scan range..... 4.50
 - transducer factor/set..... 4.211
 - Demodulation..... 4.22, 4.135
 - Detector
 - autopeak..... 4.111
 - average 4.17, 4.18, 4.112
 - CISPR 4.17
 - max peak..... 4.17, 4.18, 4.111
 - min peak..... 4.17, 4.18, 4.111
 - quasipeak 4.112
 - quasi-peak..... 4.17, 4.18, 4.62, 4.64
 - RMS 4.17, 4.19, 4.112
 - sample..... 4.111
 - Device reset (overall) 4.4
 - discontinuous interferences 4.44
 - Diskette, format..... 4.254
 - Display
 - brightness..... 4.202
 - color 4.202
 - date 4.200
 - deactivation during single sweep 4.92
 - power-save mode 1.16, 4.201
 - saturation..... 4.202
 - time 4.200
 - tint 4.202
 - title..... 4.200
 - Display line 4.193
 - Display mode
 - full screen 3.9, 4.196
 - split screen 3.9, 4.197
 - Display range
 - frequency..... 4.70
 - level..... 4.9, 4.76
 - span 4.74
 - Distribution function 4.172
 - Double dagger 5.14
- ## E
- Editing
 - limit line 4.187
 - parameter 3.18

- table 3.25
 - Electrostatic discharge 1.12
 - ENABle register part 5.19
 - Enabling the front panel keys 4.3
 - Enhancement labels 3.7
 - ENTER (key) 3.13
 - Entry
 - abort 3.13
 - activate 3.16, 3.27
 - correct 3.19
 - terminate 3.13
 - ENV 4200 4.39
 - Error messages 4.233, 9.1
 - Error variable - *iberr* 4.340
 - Error-queue query 5.32
 - ESC (key) 3.13
 - ESE (event status enable register) 5.22
 - ESH2-Z5 4.39
 - ESH3-Z5 4.39
 - ESR (event status register) 5.22
 - EVENT register part 5.19
 - Event status enable register (ESE) 5.22
 - Event status register (ESR) 5.22
 - EXT (enhancement label) 3.7
 - EXT TRIGGER/GATE input 4.54, 4.94, 8.11
 - External generator 4.287
 - External noise source 4.205
 - EZ-14 4.41
 - EZ-21 4.41
 - EZ-5 4.41
 - EZ-6 4.41
- F**
- Fast power measurement 4.156
 - FFT filter 4.14, 4.86
 - Field, first or second 4.101
 - File
 - copy 4.252
 - delete 4.252
 - rename 4.252
 - sort 4.253
 - Filter
 - band filter 4.14, 4.86
 - FFT 4.14, 4.86
 - Final measurement
 - automatic routine 4.30
 - continuation 4.32
 - halt 4.32
 - interactive routine 4.31, 4.36
 - interruption 4.32
 - measurement time 4.30, 4.36
 - start 4.31
 - FINAL PHASES 4.40
 - Firmware update 4.237
 - Firmware version 4.232
 - Fixed filter 4.86
 - FM demodulation 4.22, 4.136
 - FM modulation 4.285
 - Free-run sweep 4.53, 4.93
 - Frequency
 - axis labelling 3.4
 - center 4.70
 - counter 4.123
 - coupling of diagrams 4.199
 - display window 4.74
 - Line 4.194
 - offset 4.73
 - Offset (ext. generator) 4.298
 - offset (tracking generator) 4.283
 - receiver 4.7
 - scan 4.47
 - span 4.74
 - start 4.72
 - stop 4.72
 - switching off display 4.200
 - Frequency-converting measurements 4.283, 4.298
 - FRQ (enhancement label) 3.7
 - Full screen 3.9, 4.196
 - Full span 4.74
- G**
- GAT (enhancement label) 3.7
 - Gate
 - delay 4.98
 - external/internal 4.96
 - length 4.98
 - GET (Group Execute Trigger) 5.16
 - Getting Started with the Instrument 1.12
 - GHz-dBm (key) 3.13
- H**
- Hardcopy
 - screen 4.256
 - Hardware adjustment 4.237
 - Hardware settings, indication 3.4
 - Header 5.9
 - Help line editor 3.22
 - Hold scan 4.52
 - Horizontal sync signal 4.101
 - Hotkey
 - MIXED 4.2
 - NETWORK 4.272
 - RECEIVER 4.2, 4.6, 6.112
 - SCREEN A/B 4.2, 6.94
 - SPECTRUM 4.1, 4.69, 6.112
 - Hue, Screen 4.261
 - Hz/dB. (key) 3.13
- I**
- I/Q modulation 4.286
 - IEC Bus
 - Interface 8.13
 - IEC/IEEE bus
 - address 4.220
 - command description 6.1
 - interface 8.3
 - interface functions 8.4
 - programming examples 7.1
 - IF bandwidth 4.12
 - coupling to frequency range 4.14, 4.19
 - IFOVL 3.5
 - Impedance of input 4.79
 - Indication
 - hardware settings 3.4
 - instrument settings 3.7
 - marker information 3.4
 - Inherent noise, Correction 4.155
 - Initial configuration 4.4
 - Input
 - EXT TRIGGER/GATE 4.54, 4.94, 8.11
 - REF IN 8.12
 - Input impedance 4.79

- Instrument functions 4.1
Interface functions IEC/IEEE bus 8.4
Interfaces 8.2
Intermodulation product 4.179
Interrupt 5.31
Interrupt scan 4.52
IST flag 5.22
- K**
- Key
0 to 9 3.13
AMPT 4.9, 4.76
BACK 3.13
BW 4.12, 4.81
CAL 4.117
CANCEL 3.13
DISP 4.195
ENTER 3.13
ESC 3.13, 6.20
FILE 4.238
FREQ 4.69
GHz/dBm 3.13
Hz/dB 3.13
kHz/dB 3.13
LINES 4.183, 4.193
MEAS 4.145
MHz/dBm 3.13
MKR 4.55, 4.119
MKR FCTN 4.61, 4.127
MKR to 4.56, 4.137
PRESET 4.4, 6.6, 6.221
SETUP 4.203
SPAN 4.74
spinwheel 3.14
SWEEP 4.46, 4.90
TRACE 4.62, 4.103
TRIG 4.53, 4.93
- Keyboard
connect 1.18
connector 8.2
kHz/dB (key) 3.13
- L**
- LAN Interface 4.305
Level 4.76
axis unit 4.11
display range 4.76
line 4.194
offset (phase noise) 4.131
offset (tracking generator) 4.274
range 4.76
reference 4.76
Level display 4.9
Limit
ACP measurement 4.163
evaluation range 4.148
probability range 4.174
Limit check 4.185
ACP measurement 4.163
Limit Check 4.185
Limit line
copy 4.186
delete 4.186
domain 4.188
edit 4.187
limit check 4.185
offset 4.186
save 4.192
scaling 4.189
select 4.184
shift 4.192
unit 4.190
value 4.191
- Line
Frequency (Frequency Line 1, 2) 4.194
level (Display Line 1,2) 4.194
limit 4.184
reference (tracking generator) 4.278, 4.293
threshold 4.59, 4.140
Time (Time Line 1, 2) 4.194
Line Impedance Stabilization Networks 4.39
Line system 4.102
Lines 4.194
LISN 4.39
LO exclude 4.144
Login/out (XP controller) 1.17
Logo 4.200
Lower case 6.2
LPT interface 8.6
- M**
- Maintenance 8.1
Manual operation
return to 5.4, 5.6
switch to 4.3
Margin 4.30, 4.35
Marker 4.119
center frequency to 4.138
CF stepsize to 4.58, 4.141
indication 3.4
N dB Down 4.132
normal 4.119
peak 4.57, 4.128, 4.138
reference level to 4.138
search limit 4.59, 4.139
signal track 4.73
to trace 4.55, 4.61, 4.122, 4.136
zoom 4.126
Max hold 4.63, 4.104
Max peak detector 4.17, 4.18, 4.114
MAXH (trace info) 3.6
Maximum peak value 4.149
Maximum search 4.57, 4.138
Maximum value 4.147
Mean power (GSM burst) 4.148
Mean value 4.148
Measurement
examples 2.1
frequency-converting 4.283, 4.298
reflection 4.296
reflexion 4.281
time 4.20
transmission 4.275, 4.290
Measurement converters 4.208
Measurement example
ACP with user-specific channel configuration 4.165
adjacent-channel power for a specific standard 4.164
CCDF of a IS95 BTS signal 4.175
occupied bandwidth of a PDC signal 4.169
signal/noise power density (C/No) of an IS95 CDMA
signal 4.166
Measurement of Carrier/Noise Ratio C/N and C/No 4.176
Measurement, save 4.238
Menu
call 3.12

change keys..... 3.12
 Messages..... 4.233
 acknowledgement..... 3.8
 MHz/dBm (key)..... 3.13
 MI (trace info)..... 3.6
 Min hold..... 4.66, 4.107
 Min peak detector..... 4.17, 4.18, 4.114
 MINH (trace info)..... 3.6
 Minimum search..... 4.58, 4.141
 Mobile radio standard..... 4.154
 Mode
 analyzer..... 4.69
 receiver..... 4.6
 Modulation, external (tracking generator)..... 4.284
 Modulation depth..... 4.178
 Monitor
 connection..... 1.20
 connector..... 8.11
 Mouse
 connection..... 8.12
 connector..... 8.2
N
 Network..... 4.272
 Noise
 source, external..... 4.205
 Noise measurement..... 4.128
 NOISE SOURCE..... 8.11
 Noise, Correction..... 4.155
 Normalization..... 4.277, 4.292
 NTRansition register part..... 5.19
 Numerical values (command)..... 5.13
O
 Occupied bandwidth..... 4.167
 Offset
 frequency..... 4.73
 frequency (ext. generator)..... 4.298
 gate signal..... 4.98
 level (tracking generator)..... 4.274
 limit line..... 4.186
 phase noise..... 4.131
 reference level..... 4.79
 trigger..... 4.94
 Operating mode
 analyzer..... 4.69
 receiver..... 4.6
 Receiver..... 4.6
 Operating time..... 4.232
 Option
 ESPI-B2 - PRESELECTOR..... 4.10
 FSP-B10 – External Generator..... 4.287
 FSP-B6 – TV and RF Trigger..... 4.100
 FSP-B9 – Tracking Generator..... 4.272
 Order number..... 4.231
 Output
 AF OUTPUT..... 8.2
 IF 20.4 MHz Out..... 8.12
 noise source control..... 8.11
 REF OUT..... 8.12
 Output level
 control..... 4.274
 OVEN..... 3.5
 Overwrite mode..... 4.63, 4.104
 OVL..... 3.5, 4.282, 4.297

P

Packing..... 8.1
 Parallel poll..... 5.32
 Parallel poll enable register (PPE)..... 5.22
 Parameter
 block data..... 5.14
 boolean..... 5.13
 editing..... 3.18
 numerical values..... 5.13
 selection..... 3.15
 string..... 5.14
 text..... 5.14
 Parameter coupling..... 4.197
 Password
 service functions..... 4.235
 Windows XP..... 1.17
 Path..... 4.251
 Peak
 detector..... 4.17, 4.64
 Peak excursion..... 4.60
 Peak list..... 4.25
 PEAK LIST ON / OFF..... 4.65
 Peak search..... 4.57, 4.128, 4.138
 PHASE N..... 4.40
 Phase noise measurement..... 4.130
 Phase setting..... 4.40
 PK (trace info)..... 3.6
 Polarity
 external trigger/gate..... 4.97
 trigger edge..... 4.54, 4.94
 video..... 4.102
 Power bandwidth percentage..... 4.167
 Power cables..... 8.1
 Power measurement..... 4.145
 CP/ACP..... 4.151
 Fast..... 4.156
 occupied bandwidth..... 4.167
 signal amplitude statistics..... 4.170
 Time domain..... 4.146
 trace..... 4.163
 Power, mean..... 4.148
 Power-save mode
 display..... 1.16
 hard disk..... 1.16
 PPE (parallel poll enable register)..... 5.22
 Preamplification..... 4.10, 4.206, 4.207
 Preparing the Instrument for Operation..... 1.12
 PRESCAN PHASES..... 4.40
 Preselection..... 4.206
 Preset instrument..... 4.4
 Pretrigger..... 4.94
 PRINT SCREEN (Gate Signal)..... 4.98
 Printer
 configuration..... 4.255
 connection..... 1.21, 4.257, 8.6
 interface..... 8.6
 start..... 4.256
 PRN (enhancement lable)..... 3.7
 Probe Power connector..... 8.2
 Protective earth conductor..... 4.40
 Protective earth setting..... 4.40
 PTRansition register part..... 5.19
 Putting into operation
 AC supply connection..... 1.14

Q

QP (trace info).....	3.6
Quasi-peak detector.....	4.17, 4.18, 4.62, 4.64, 4.112
Query.....	5.12, 5.32
Question mark.....	5.12, 5.14
Quotation mark.....	5.14

R

Rackmounting.....	1.13
Receiver.....	4.6
frequency.....	4.7
frequency stepsize.....	4.8
level.....	4.9
Recording the correction data.....	4.117
Reference	
dataset (tracking generator).....	4.282
external.....	4.205
fixed.....	4.124
frequency.....	4.124
level to marker level.....	4.138
line (tracking generator).....	4.278, 4.293
position for normalization.....	4.293
Reference data set	
ext.generator.....	4.297
Reference level.....	4.76
channel power.....	4.156
coupling of diagrams.....	4.199
offset.....	4.79
position.....	4.79
to marker level.....	4.138
Reference point	
frequency.....	4.124
frequency (phase noise).....	4.132
level.....	4.124
offset.....	4.124
level (phase noise).....	4.131
offset.....	4.131
time.....	4.125
x axis.....	4.125
Reference value	
channel power.....	4.155
time domain power.....	4.149
Reflection measurement.....	4.281, 4.296
Remote control	
basics.....	5.1
IEC/IEEE bus.....	5.4
RS-232-C.....	5.5
switch over.....	5.3
Remote Control	
RSIB.....	4.337
Rename	
directory.....	4.252
file.....	4.252
Reset	
device.....	4.4
status reporting system.....	5.33
Resolution bandwidth.....	4.13, 4.82
Resolution counter.....	4.123
RF attenuation.....	4.9, 4.78
RFI reception.....	4.6
RM (trace info).....	3.6
RMS detector.....	4.17, 4.19, 4.112, 4.114
RMS value.....	4.147
RS-232-C	
configuration.....	4.223
interface.....	8.7
transmission parameters.....	8.8

S

SA (trace info).....	3.6
Sample detector.....	4.114
Sample number.....	4.173
Saturation.....	4.202
Saturation, Screen.....	4.262
Save	
configuration.....	4.238
limit line.....	4.192
measurement.....	4.238
Scalar reflection measurement.....	4.281, 4.296
Scaling.....	4.77
level axis.....	4.79
limit line.....	4.189
x- and y-axis (signal statistic).....	4.173
Scan.....	4.43
default setup.....	4.44
entry.....	4.46
hold.....	4.52
run.....	4.52
stop.....	4.52
SCPI	
conformity information.....	6.1
introduction.....	5.8
version.....	5.1
Screen.....	3.1
brightness.....	4.261
Colors.....	4.262
full screen.....	4.196
hue.....	4.261
Saturation.....	4.262
split screen.....	3.9, 4.197
subdivision.....	3.2
Screen, Colors.....	4.262
Search	
bandwidth.....	4.73
minimum.....	4.58, 4.141
peak.....	4.57, 4.128, 4.138
peak excursion.....	4.60
PEAK EXCURSION.....	4.134, 4.142
range.....	4.59, 4.139
Search method for peak list.....	4.30
Selftest.....	4.236
Sensitivity	
APD measurement.....	4.174
CCDF measurement.....	4.174
Serial interface.....	8.7
configuration.....	4.223
Serial number.....	4.231
Serial poll.....	5.31
Service functions.....	4.234
Service Pack.....	1.17
Service request (SRQ).....	5.21, 5.31
Service request enable register (SRE).....	5.21
Setting Up the Instrument.....	1.12
Settings, indication.....	3.7
Setup.....	4.203
general.....	4.220
SGL (enhancement label).....	3.7
Shutdown (NT controller).....	1.17
Sign (key).....	3.13
Signal amplitude statistics.....	4.170
Signal count.....	4.123
Signal tracking.....	4.73
search bandwidth.....	4.73
Single sweep.....	4.90
Softkey	
% POWER BANDWIDTH.....	4.167, 6.185
= CENTER.....	4.71, 4.72
= MARKER.....	4.71, 4.72
0.1 * RBW.....	4.71, 6.168, 6.169

0.1 * SPAN.....	4.70, 6.168, 6.169	CONT AT REC FREQ	4.52, 6.106
0.5 * RBW.....	4.71, 6.168, 6.169	CONT DEMOD.....	4.136, 6.52
0.5 * SPAN.....	4.70, 6.168, 6.169	CONT MEAS.....	4.175, 6.106, 6.107
1 MHz.....	4.13, 6.153	CONTINUE SGL SWEEP.....	4.91, 6.106, 6.107
10 dB MIN.....	4.78	CONTINUOUS SCAN.....	4.51, 6.106
10 DB MIN ON/OFF.....	4.10, 6.109	CONTINUOUS SWEEP.....	4.89, 4.90, 6.106, 6.107
120 kHz.....	4.13, 6.153	COPY.....	4.252, 4.253, 6.118
200 Hz.....	4.13, 6.153	COPY LIMIT LINE.....	4.186, 6.20
9 kHz.....	4.13, 6.153	COPY TRACE.....	4.68, 4.110, 6.225
ABSOLUTE PEAK/MIN.....	6.12, 6.13	COUPLING DEFAULT.....	4.86, 6.154, 6.191
ACP LIMIT CHECK.....	4.163, 6.22	COUPLING RATIO.....	4.84, 6.154
ACP REF SETTINGS.....	4.160, 6.184	COUPLING TABLE.....	4.197
ADD TO PEAK LIST.....	4.57	CP/ACP ABS/REL.....	4.161, 6.183
ADJ CHAN BANDWIDTH.....	4.159, 6.183	CP/ACP CONFIG.....	4.158, 6.22, 6.182
ADJ CHAN SPACING.....	4.160, 6.182	CP/ACP ON/OFF.....	4.153, 6.59, 6.60, 6.63
ADJUST AXIS.....	4.50	CP/ACP STANDARD.....	4.154, 6.63
ADJUST REF LVL.....	4.156, 4.168, 6.185	DATA SET CLEAR.....	4.248, 6.122
ADJUST SETTINGS.....	4.174, 4.177, 6.80, 6.185	DATA SET LIST.....	4.248
ADJUST SETTINGS (occupied bandwidth).....	4.168	DATAENTRY OPAQUE.....	4.201
ADJUST SETTINGS (power measurements).....	4.162	dBm.....	4.11, 4.77, 6.84, 6.237
ALL MARKER OFF.....	4.126, 6.10, 6.40	dBmV.....	4.77, 6.84, 6.237
AM.....	4.22, 4.136, 6.51, 6.16, 6.233	dBpT.....	4.11, 6.84, 6.237
AMPERE.....	4.77, 6.84, 6.237	dBpW.....	4.77, 6.84, 6.237
ANNOTATION ON/OFF.....	4.200, 6.92	dBµA.....	4.11, 4.77, 6.84, 6.237
APD ON/OFF.....	4.172, 6.79, 6.81	dBµV.....	4.11, 4.77, 6.84, 6.237
area.....	3.10	DECIM SEP.....	4.27, 4.68, 4.110, 4.254, 6.100
ASCII FILE EXPORT.....	4.27, 4.66, 4.108, 4.254, 6.100, 6.122	DEFAULT COLORS.....	4.201, 6.93, 6.101
AUTO COARSE.....	4.8	DEFAULT CONFIG.....	4.247, 6.125
AUTO FINE.....	4.8	DEFAULT SETTINGS.....	4.174, 6.81
AUTO RANGE ON/OFF.....	4.10	DELETE.....	4.252, 6.119, 6.121, 6.160, 6.162
AUTO SELECT.....	4.113, 6.164	DELETE (peak list).....	4.26
AUTOMATIC FINAL.....	4.30, 4.32, 4.36	DELETE FACTOR/SET.....	4.211
AUTOPREAMP ON/OFF.....	4.10, 6.111	DELETE LIMIT LINE.....	4.186, 6.21
AVERAGE.....	4.18, 4.64, 4.105, 6.98, 6.151, 6.165	DELETE RANGE.....	4.50, 4.218
AVERAGE ON/OFF.....	4.149, 6.68, 6.69, 6.71, 6.72, 6.73	DELETE VALUE.....	4.192
AVG MODE LOG/LIN.....	4.107, 6.77, 6.152	DEMOD.....	4.22
BARGRAPH MAXHOLD.....	4.198	DEMOD ON/OFF.....	4.22, 6.163
BARGRAPH RESET.....	4.199	DETECTOR.....	4.18, 4.64, 4.113, 6.164
BLANK.....	4.64, 4.106, 6.98	DETECTOR AUTOPEAK.....	4.113, 6.164
BRIGHTNESS.....	4.202, 4.261, 6.93, 6.102	DETECTOR AVERAGE.....	4.115, 6.164
C/N.....	4.176, 4.177	DETECTOR MAX PEAK.....	4.114, 6.164
C/No.....	4.177	DETECTOR MIN PEAK.....	4.114, 6.164
CAL ABORT.....	4.118, 6.85	DETECTOR QPK.....	4.115, 6.164
CAL CORR ON/OFF.....	4.118, 6.86	DETECTOR RMS.....	4.114, 6.164
CAL GEN 128 MHZ.....	4.235, 6.87	DETECTOR SAMPLE.....	4.114, 6.164
CAL REFL OPEN.....	4.281, 4.296, 6.157, 6.158	DEVICE 1/2.....	4.256, 6.103, 6.104, 6.105, 6.121, 6.217
CAL REFL SHORT.....	4.281, 4.296, 6.157, 6.158	DISABLE ALL ITEMS.....	4.198
CAL RESULTS.....	4.118, 6.86	DISPLAY LINE 1.....	4.194
CAL TOTAL.....	4.117, 6.85	DISPLAY PWR SAVE.....	4.201, 6.92
CAL TRANS.....	4.276, 4.291, 6.157	EDIT.....	4.211, 4.212, 4.216, 6.159, 6.161
CCDF ON/OFF.....	4.172, 6.79, 6.81	EDIT ACP LIMITS.....	4.163, 6.22, 6.23, 6.24, 6.25, 6.26, 6.27, 6.28, 6.29
CCVS INT / EXT.....	4.102, 6.195	EDIT COMMENT.....	4.245, 6.125
CENTER.....	4.70, 6.168	EDIT FREQUENCY.....	4.26
CENTER = MKR FREQ.....	4.138, 6.54	EDIT LIMIT LINE.....	4.188, 6.19, 6.31, 6.32, 6.34, 6.36, 6.37, 6.38
CENTER A = MARKER B.....	4.199, 6.113	EDIT PATH.....	4.245, 4.251, 6.117, 6.121
CENTER B = MARKER A.....	4.199, 6.113	EDIT PEAK LIST.....	4.26, 4.35
CF STEPSIZE.....	6.168	ENABLE ALL ITEMS.....	4.198
CHAN PWR / HZ.....	4.161, 6.62	ENABLE ALL ITEMS.....	4.247, 6.124
CHAN PWR ACP.....	4.153, 6.59	ENTER PASSWORD.....	4.235, 6.220
CHANNEL BANDWIDTH.....	4.167, 4.177, 6.183	ESH2-Z5/ENV 4200.....	4.39, 6.16, 6.109
CHANNEL SPACING.....	6.181	ESH3-Z5.....	4.39, 6.167, 6.109
CISPR AVERAGE.....	4.19	EXCLUDE LO.....	4.144, 6.43
CLEAR ALL MESSAGES.....	4.233, 6.219	EXT AM.....	4.285
CLEAR/WRITE.....	4.63, 4.104, 6.98	EXT AMFSP.....	6.196
CNT RESOL.....	4.123, 6.42	EXT FM.....	4.285, 6.197
COLOR ON/OFF.....	4.260, 6.103	EXT I/Q.....	4.286, 6.196
COLORS.....	4.257, 4.260	EXT SOURCE.....	4.299
COM INTERFACE.....	4.223, 6.216	EXT SRC ON/OFF.....	4.300, 6.199
COMMENT SCREEN A/B.....	6.105	EXTERN.....	4.54, 4.94, 6.193, 6.233
CONFIGURE NETWORK.....	4.227		
CONT AT HOLD.....	4.52		

- FAST ACP ON/OFF..... 4.156, 6.186
 FILE MANAGER..... 4.250, 6.117
 FILTER TYPE..... 4.86, 6.155
 FINAL AVERAGE..... 4.65, 6.165
 FINAL CISPR AV..... 4.65
 FINAL MAX PEAK..... 4.65, 6.165
 FINAL MEAS TIME..... 4.30, 4.36, 6.167
 FINAL MIN PEAK..... 4.65, 6.165
 FINAL PHASES..... 4.40, 6.109
 FINAL QUASISPEAK..... 4.65, 6.165
 FINAL RMS..... 4.65, 6.165
 FIRMWARE UPDATE..... 4.237, 6.219
 FM..... 4.22, 4.136, 6.51, 6.163, 6.233
 FORMAT DISK..... 4.254, 6.119
 FREE RUN..... 4.53, 4.93, 6.233
 FREQ AXIS LIN/LOG..... 4.51, 4.75, 6.95
 FREQUENCY LINE 1/2..... 4.194
 FREQUENCY OFFSET..... 4.73, 4.283, 4.298, 6.170, 6.197
 FREQUENCY SWEEP..... 4.303, 6.200, 6.201
 FSP MODE ON/OFF..... 6.221
 FULL SCREEN..... 4.196, 6.92
 FULL SIZE DIAGRAM..... 4.156
 FULL SPAN..... 4.74, 6.169
 GATE DELAY..... 4.98, 6.193
 GATE LENGTH..... 4.98, 6.193
 GATE MODE LEVEL/EDGE..... 4.97, 6.193
 GATE SETTINGS..... 4.97, 6.192
 GATED TRIGGER..... 4.96, 6.192, 6.193
 GEN REF INT/EXT..... 4.304
 GENERAL SETUP..... 4.220
 GPIB..... 4.220
 GPIB ADDRESS..... 4.220, 6.213
 GPIB LANGUAGE..... 4.221
 GRID ABS/REL..... 4.79, 6.95
 GRID MIN LEVEL..... 4.11, 6.97
 GRID RANGE LOG 100 dB..... 4.11
 GRID RANGE LOG MANUAL..... 4.11
 HARDCOPY ABORT..... 6.101
 HARDWARE INFO..... 4.231, 6.6, 6.89
 HOLD FINAL MEAS..... 4.32
 HOLD SCAN..... 4.52, 6.8
 HOR SYNC..... 4.101, 6.236
 ID STRING FACTORY..... 4.220
 ID STRING USER..... 4.221
 IF POWER..... 4.94, 6.193, 6.233, 6.235
 INPUT CAL..... 4.234, 4.235, 6.87, 6.88
 INPUT RF..... 4.234, 4.235, 6.87
 INS AFTER RANGE..... 4.50, 4.218
 INS BEFORE RANGE..... 4.50, 4.218
 INSERT (peak list)..... 4.26
 INSERT VALUE..... 4.191
 INSTALL OPTION..... 4.229
 INTERACTIVE..... 4.31, 4.32, 4.36
 ITEMS TO SAVE/RECALL..... 4.246, 6.123
 LAST SPAN..... 4.75
 LEFT LIMIT..... 4.59, 4.134, 4.140, 6.40, 6.41
 LIMIT ON/OFF..... 4.148, 6.40
 LINES 625 / 525..... 4.102, 6.236
 LISN..... 4.39
 LOCAL..... 4.3, 5.6
 LOGO ON/OFF..... 4.200, 6.92
 MAIN PLL BANDWIDTH..... 4.89
 MAKE DIRECTORY..... 4.251, 6.120
 MANUAL..... 4.71
 MARGIN..... 4.30, 4.35
 MARKER 1 to 44.55, 4.120, 6.10, 6.11, 6.39, 6.40, 6.43
 MARKER DEMOD..... 4.135, 6.51
 MARKER NORM/DELTA..... 4.55, 4.120, 6.9
 MARKER TRACK..... 4.57, 6.42
 MARKER ZOOM..... 4.61, 4.126, 6.51
 MAX HOLD..... 4.63, 4.104, 6.98
 MAX HOLD ON/OFF..... 4.149, 6.68, 6.70, 6.71, 6.73
 MAX PEAK..... 4.18, 4.64, 6.165
 MAX-MIN THRESHOLD..... 6.166
 MEAN..... 4.148, 6.70
 MEAS TIME..... 4.20
 MEASURE..... 4.32
 MIN..... 4.58, 4.141, 6.12, 6.45
 MIN HOLD..... 4.66, 4.107, 6.98
 MIN PEAK..... 4.64, 6.165
 MIXER LOW NOISE..... 4.78
 MKR -> CF STEPSIZE..... 4.58, 4.141, 6.55
 MKR -> STEPSIZE..... 6.55
 MKR -> TRACE.....
 4.55, 4.58, 4.61, 4.122, 4.136, 4.140, 6.10, 6.40
 MKR DEMOD ON/OFF..... 4.135, 6.52
 MKR STOP TIME..... 4.136, 6.52
 MODULATION..... 4.284
 MODULATION DEPTH..... 4.178, 6.53
 MODULATION OFF..... 4.286, 6.196, 6.197
 mult carr ACP..... 4.153
 N dB DOWN..... 4.132, 6.49, 6.50
 NAME..... 4.188, 6.19, 6.20, 6.21, 6.31, 6.32, 6.35, 6.37
 NETWORK..... 4.288
 NETWORK..... 4.288
 NETWORK LOGIN..... 4.228
 NEW..... 4.211, 4.212, 4.216, 6.160
 NEW LIMIT LINE.....
 4.188, 6.19, 6.20, 6.21, 6.31, 6.32, 6.34, 6.36
 NEXT MIN..... 4.58, 4.141, 6.13, 6.45, 6.46
 NEXT MIN LEFT..... 4.58, 4.142
 NEXT MIN RIGHT..... 4.58, 4.142
 NEXT PEAK..... 4.57, 4.139, 6.12, 6.13, 6.44
 NEXT PEAK LEFT..... 4.139
 NEXT PEAK RIGHT..... 4.139
 NO OF PEAKS..... 4.30, 4.35, 6.78
 NO OF SAMPLES..... 4.173, 6.79
 NO. OF ADJ CHAN..... 4.158, 6.182
 NO. OF TX CHAN..... 4.158, 6.182
 NOISE CORR ON/OFF..... 4.155, 6.186
 NOISE MEAS..... 4.128, 6.51
 NOISE SRC ON/OFF..... 4.205, 6.88
 NORMALIZE..... 4.277, 4.292, 6.157
 NUMBER OF SWEEPS..... 4.150, 6.192
 OCCUP BW ON/OFF..... 4.167, 6.59, 6.60, 6.63
 OCCUPIED BANDWIDTH..... 4.167, 6.59
 OPTIMIZED COLORS..... 4.261
 OPTIONS..... 4.229
 PARAM COUPLING..... 4.197
 PE FLOATING..... 4.40, 6.110, 6.167
 PE GROUNDED..... 4.40, 6.110, 6.167
 PEAK..... 4.57, 4.128, 4.138, 4.147, 6.11, 6.44, 6.67
 PEAK EXCURSION..... 4.60, 4.134, 4.142, 6.46
 PEAK LIST..... 4.133, 6.47
 PEAK LIST OFF..... 4.134, 6.47
 PEAK LIST ON/OFF..... 4.65, 6.98
 PEAK SEARCH..... 4.25, 4.132, 4.134, 6.78
 PEAKS/SUBRANGES..... 4.30, 6.78
 PERCENT MARKER..... 4.172, 6.44
 PH NOISE ON/OFF..... 4.131, 6.15, 6.16
 PHASE L1/L2/L3..... 4.40, 6.109, 6.167
 PHASE N..... 4.40, 6.109, 6.167
 PHASE NOISE..... 4.130, 6.15
 POLARITY POS/NEG..... 4.54, 4.94, 4.97, 6.193, 6.236
 PORT 0 0/1..... 4.222, 6.126
 POWER ABS/REL..... 4.149, 6.74, 6.198
 POWER ON/OFF..... 4.147, 6.67, 6.69, 6.70, 6.72, 6.74
 PREAMP ON/OFF..... 4.10, 4.207, 6.110
 PREDEFINED COLORS..... 4.202, 4.262, 6.94, 6.103
 PRESCAN PHASES..... 4.40, 6.109
 PRESELECT ON/OFF..... 4.207, 6.111
 PREVIOUS ZOOM..... 4.61
 PRINT SCREEN..... 4.98, 4.256, 6.104, 6.121
 PRINT TABLE..... 4.256, 6.104, 6.105, 6.121

PRINT TRACE	4.256, 6.104, 6.105, 6.121
PULSE FREQ	6.90
PULSE xx	4.235, 6.87
PWR OFFSET	4.274, 4.289
QP RBW UNCOUPLED	4.14, 4.19, 6.154
QUASIPeAK	4.18, 4.64, 6.165
RANGE	4.218
RANGE LINEAR	4.77, 6.97
RANGE LOG 100 dB	4.76, 6.97
RANGE LOG MANUAL	4.77, 6.97
RANGES 1-5/6-10	4.50
RBW / VBW MANUAL	4.85, 6.155
RBW / VBW NOISE [10]	4.85, 6.155
RBW / VBW PULSE [1]	4.85, 6.155
RBW / VBW SINE [1/3]	4.84, 6.155
RECALL	4.244, 4.295, 6.119, 6.158
RECEIVER FREQUENCY	4.7, 6.168
REF FXD ON/OFF	4.124, 6.14
REF LEVEL	4.76, 6.96
REF LEVEL = MKR LVL	4.138, 6.55
REF LEVEL COUPLED	4.199, 6.113
REF LEVEL OFFSET	4.79, 6.96
REF LEVEL POSITION	4.79, 6.97
REF POINT FREQUENCY	4.124, 4.132, 6.15
REF POINT LEVEL	4.124, 4.131, 6.14
REF POINT LVL OFFSET	4.124, 4.131, 6.15
REF POINT TIME	4.125, 6.15
REF POINT x-LEVEL	4.125, 6.15
REF VALUE	4.279, 4.294, 6.96
REF VALUE POSITION	4.278, 4.293, 6.97
REFERENCE FIXED	4.124, 6.14
REFERENCE INT/EXT	4.205, 6.187
REMOVE OPTION	4.229
RENAME	4.252, 6.120
RES BW	4.13, 4.173, 6.153
RES BW AUTO	4.83, 6.154
RES BW MANUAL	4.82, 6.153, 6.154
RESTORE FIRMWARE	4.237
RF ATTEN AUTO	4.78, 6.109
RF ATTEN MANUAL	4.9, 4.78, 6.108
RF INPUT 50 Ω / 75 Ω	4.79, 6.110
RF INPUT AC/DC	4.11, 4.78
RF POWER	4.100, 6.233, 6.235
RIGHT LIMIT	4.59, 4.134, 4.140, 6.40, 6.41
RMS	4.19, 4.64, 4.147, 6.69, 6.165
RUN FINAL MEAS	4.31, 4.36, 4.37
RUN SCAN	4.52, 6.107
SATURATION	4.202, 4.262, 6.93, 6.102
SAVE	4.243, 6.121
SAVE LIMIT LINE	4.192
SAVE TRD FACTOR	4.215
SAVE TRD SET	4.219
SCALING	4.173, 6.80
SCAN COUNT	4.64, 6.191, 6.192
SCREEN COLORS	4.261
SCREEN TITLE	4.200, 6.94, 6.95
SEARCH LIMIT OFF	4.60, 4.140, 6.40
SEARCH LIMITS	4.59, 4.139, 6.40
SEARCH NEXT LEFT	6.12, 6.13, 6.46
SEARCH NEXT PEAK LEFT	4.57
SEARCH NEXT PEAK RIGHT	4.57
SEARCH NEXT RIGHT	6.12, 6.13, 6.44, 6.46
SELECT GENERATOR	4.300, 6.214, 6.215
SELECT ITEMS	4.247, 6.123, 6.124
SELECT LIMIT LINE	4.184, 6.19, 6.20, 6.34, 6.37
SELECT MARKER	4.57, 4.128, 4.137, 4.181, 6.39
SELECT OBJECT	4.201, 4.261
SELECT TRACE	4.63, 4.73, 4.104, 4.163, 6.65, 6.186
SELFTEST	4.236, 6.7
SELFTEST RESULTS	4.236, 6.88
SERVICE	4.234, 6.87
SET CP REFERENCE	4.155, 6.184
SET REFERENCE	4.149, 6.74
SET TO DEFAULT	4.262
SETTINGS COUPLED	4.59, 6.43
SGL SWEEP DISP OFF	4.92, 6.107
SHIFT X LIMIT LINE	4.192, 6.32
SHIFT Y LIMIT LINE	4.192, 6.38
SIGNAL COUNT	4.123, 6.42
SIGNAL STATISTIC	4.172
SIGNAL TRACK	4.73, 6.64
SINGLE MEAS	4.175, 6.106, 6.107
SINGLE SCAN	4.51, 6.106
SINGLE SWEEP	4.90, 6.106, 6.107
SOFT FRONT PANEL	4.230
SORT BY DELTA LIMIT	4.27
SORT BY FREQUENCY	4.26
SORT MODE	4.253
SORT MODE FREQ/LEVEL	4.134
SOURCE CAL	4.275, 4.290
SOURCE ON/OFF	4.273
SOURCE POWER	4.274, 4.288, 6.197, 6.201
SPAN MANUAL	4.74, 6.169
SPAN/RBW AUTO [50]	4.85, 6.154
SPAN/RBW MANUAL	4.86, 6.154
SPLIT SCREEN	4.197, 6.92
STANDARD DEVIATION	4.148, 6.72
START	4.8, 4.72, 6.169
START LIMIT	4.148, 4.149, 6.41
STARTUP RECALL	4.249, 6.120
STATISTICS	4.232, 6.5
STEPSIZE	4.8
STEPSIZE = FREQ	4.8
STEPSIZE MANUAL	4.8, 4.72, 6.168
STOP	4.8, 4.72, 6.169
STOP FINAL MEAS	4.32
STOP LIMIT	4.148, 4.149, 6.41
STOP SCAN	4.52, 6.8
SWEEP COUNT	4.91, 4.106, 6.192
SWEEP POINTS	4.92, 6.194
SWEPTIME AUTO	4.84, 4.91, 6.191
SWEPTIME MANUAL	4.74, 4.83, 4.91, 6.191
SYSTEM INFO	4.231
SYSTEM MESSAGES	4.233, 6.219
T1-T2	4.116, 6.76
T1-T3	4.116, 6.76
THRESHOLD	4.59, 4.134, 4.140, 6.82, 6.83
THRESHOLD ON/OFF	4.35
THRESHOLD SCAN	6.166
TIME DOM POWER	4.146, 6.67, 6.69, 6.70, 6.72
TIME DOMAIN	4.51
TIME LINE 1/2	4.194
TIME+DATE	4.226, 6.218, 6.221
TIME+DATE ON/OFF	4.200, 6.95
TINT	4.202, 4.261, 6.93, 6.102
TOI	4.180, 6.54
TRACE MATH	4.116, 6.76
TRACE MATH OFF	4.116, 6.77
TRACE POSITION	4.116, 6.76
TRACK BW	4.73, 6.64
TRACK ON/OFF	4.73, 6.64
TRACK THRESHOLD	4.73, 6.65
TRACKING	4.273
TRANSDUCER	4.209, 6.158
TRANSDUCER FACTOR	4.210, 6.158, 6.159
TRANSDUCER SET	4.210, 6.160, 6.162
TRIGGER OFFSET	4.94, 6.235
TUNE TO MARKER	4.57, 6.54
TV TRIG SETTINGS	4.101
TV TRIGGER ON/OFF	4.101, 6.195
UNIT	4.11, 4.77, 6.84, 6.237
USE CURR SETTINGS	4.51
USE SCAN TABLE	4.47, 6.188, 6.189, 6.190
USER DEFINED	4.261

USER PORT	4.222
USER PORT IN/OUT	4.222, 6.110
VALUES	4.191, 6.31, 6.33, 6.36
VBW LIN LOG	4.89, 6.156
VERT SYNC	4.101, 6.236
VERT SYNC EVEN FIELD	4.101, 6.236
VERT SYNC ODD FIELD	4.101, 6.236
VIDEO	4.53, 4.93, 6.233, 6.235
VIDEO BW AUTO	4.83, 6.155
VIDEO BW MANUAL	4.82, 6.155
VIDEO POL POS / NEG	4.102, 6.236
VIEW	4.63, 4.106, 6.98
VIEW TRANSDUCER	4.211
VOLT	4.77, 6.84, 6.237
WATT	4.77, 6.84, 6.237
X * RBW	4.71, 6.168, 6.169
X * SPAN	4.70, 6.168, 6.169
X OFFSET	4.186, 6.32
X-AXIS RANGE	4.174, 6.80
X-AXIS REF LEVEL	4.173, 6.80
Y OFFSET	4.186, 6.34, 6.37
Y-AXIS MAX VALUE	4.174, 6.80
Y-AXIS MIN VALUE	4.174, 6.81
ZERO SPAN	4.74, 6.169
ZOOM OFF	4.61
ZOOM x-AXIS	4.98
Span	4.74
Special characters	6.2
Spectrum analyzer mode	4.69
Spinwheel	3.14
Split screen	3.9, 4.197
Squelch	4.135
SRE (service request enable register)	5.21
SRQ (service request)	5.21, 5.31
Standard deviation	4.148
Standard, mobile radio	4.154
Start frequency	4.72
Statistics	4.170
Status byte (STB)	5.21
Status information	3.5
IFOVL	3.5
OVEN	3.5
OVL	3.5
UNCAL	3.5
STATus OPERation register	5.23
STATus QUESTionable register	5.24
ACPLimit register	5.25
FREQUENCY register	5.26
LIMit register	5.27
LMARgin register	5.28
POWer register	5.29
TRANsducer	5.30
Status register	
CONDition part	5.19
ENABLE part	5.19
ESE	5.22
ESR	5.22
EVENT part	5.19
NTRansition part	5.19
overview	5.20
PPE	5.22
PTRansition part	5.19
SRE	5.21
STATus OPERation	5.23
STATus QUESTionable ACPLimit	5.25
STATus QUESTionable FREQUENCY	5.26
STATus QUESTionable LIMit	5.27
STATus QUESTionable LMARgin	5.28
STATus QUESTionable POWer	5.29
STATus QUESTionable TRANsducer	5.30
STB	5.21
structure	5.18
sum bit	5.19
Status reporting system	5.18
resetting values	5.33
STB (status byte)	5.21
Stepsize	4.72
center frequency	4.70
coupling	4.72
receiver frequency	4.8
Stop frequency	4.72
Store trace	4.254
Storing	8.1
String	5.14
Subrange maxima list	4.25
Suffix	5.10
Sum bit	5.19
Supply voltage, external noise source	4.205
Sweep	
continue single sweep	4.91
continuous	4.90
count	4.91
coupling	4.80
free run	4.53, 4.93
gated	4.95, 4.96
settings	4.90
single	4.90
time	4.74, 4.91
coupling	4.84
Switching cycles	4.232
Switching on/off	1.14
Sync signal	4.101
Syntax elements of commands	5.14
System messages	4.233
T	
T1-T2 (trace info)	3.6
T1-T3 (trace info)	3.6
Table	
operation	3.25
scrolling	3.27
TDF (enhancement lable)	3.7
TDS (enhancement lable)	3.7
Test	
functional	1.16
selftest	4.236
Test receiver	4.6
Text parameter	5.14
Third Order Intercept	4.179
Threshold	
line	4.59, 4.140
signal tracking	4.73
Time	4.200
input	4.226
Line	4.194
Time axis	4.74
time domain analysis	4.44
Tint	4.202
Title for the active diagram	4.200
TOI	4.179
Trace	4.62, 4.63, 4.103, 4.104
average	4.105
averaging	4.107
blank	4.64, 4.106
Clear/Write	4.63, 4.104
copy	4.68, 4.110
freeze	4.63, 4.106
math	4.116
max hold	4.63, 4.104
min hold	4.66, 4.107
position for 0 difference	4.116

power measurement	4.163
select	4.62, 4.103
signal tracking.....	4.73
Trace info.....	3.6
Tracking generator	4.272
Transducer.....	4.208
entry.....	4.212
set.....	4.216
switch on.....	4.209
Transmission measurement	4.275, 4.290
Transmission parameters RS-232-C/COM	8.8
TRG (enhancement table)	3.7
Trigger	
external.....	4.53, 4.54, 4.94
external gate	4.96
free run	4.53, 4.93
gated sweep	4.97
IF power.....	4.94
offset.....	4.94
RF power	4.100
scan.....	4.53
slope.....	4.54, 4.94
sweep	4.93
video.....	4.93
TUNE TO MARKER.....	4.57
TV trigger	4.101

U

UNCAL.....	3.5
Unit	
level axis.....	4.77
limit line.....	4.190
Unit (key).....	3.13
Universal command.....	8.5
Upper case.....	6.2
USB connection	8.12
User interface.....	4.222
User Interface.....	8.10
User port	
configuration	4.222

V

Vertical sync signal	4.101
Video bandwidth.....	4.82
Video polarity	4.102
Video triggering	4.93
VIEW (trace info).....	3.6
View trace	4.106
V-networks	4.39

W

Weighting modes	4.20
White space	5.14
Windows XP.....	1.17
administrator	1.17
login	1.17
password	1.17
shutdown	1.17
Windows-XP Servicepacks	1.17

X

XP computer.....	1.17
------------------	------

Z

Zero span	4.74
Zoom	4.126
amplitude.....	4.63, 4.106
x-AXIS (gate signal).....	4.98