

Agilent N9310A RF Signal Generator

Quick Start Guide



Agilent Technologies

Notices

© Agilent Technologies, Inc. 2006

No part of this manual may be reproduced in any form or by any means (including electronic storage and retrieval or translation into a foreign language) without prior agreement and written consent from Agilent Technologies, Inc. as governed by United States and international copyright laws.

Edition

First Edition, June 2006

Printed in China

Agilent Technologies, Inc.
Qianfeng Hi-Tech Industrial Park
Chengdu Hi-Tech Industrial Development
Zone(West District)
Chengdu, 611731, P.R.C

Software Revision

This guide is valid for V1.0 revisions of the Agilent N9310A RF Signal Generator software. Due to our continuous effort to improve our product, please go to our web site to download the latest version of the Quick Start Guide or User's Guide.

Warranty

The material contained in this document is provided "as is," and is subject to being changed, without notice, in future editions. Further, to the maximum extent permitted by applicable law, Agilent disclaims all warranties, either express or implied, with regard to this manual and any information contained herein, including but not limited to the implied warranties of merchantability and fitness for a particular purpose. Agilent shall not be liable for errors or for incidental or consequential damages in connection with the furnishing, use, or performance of this document or of any information contained herein. Should Agilent and the user have a separate written agreement with warranty terms covering the material in this document that conflict with these terms, the warranty terms in the separate agreement shall control.

Technology Licenses

The hardware and/or software described in this document are furnished under a license and may be used or copied only in accordance with the terms of such license.

Restricted Rights Legend

U.S. Government Restricted Rights. Software and technical data rights granted to the federal government include only those rights customarily provided to end user customers. Agilent provides this customary commercial license in Software and technical data pursuant to FAR 12.211 (Technical Data) and 12.212 (Computer Software) and, for the Department of Defense, DFARS 252.227-7015 (Technical Data - Commercial Items) and DFARS 227.7202-3 (Rights in Commercial Computer Software or Computer Software Documentation).

Safety Notices

CAUTION

A **CAUTION** notice denotes a hazard. It calls attention to an operating procedure, practice, or the like that, if not correctly performed or adhered to, could result in damage to the product or loss of important data. Do not proceed beyond a **CAUTION** notice until the indicated conditions are fully understood and met.

WARNING

A **WARNING** notice denotes a hazard. It calls attention to an operating procedure, practice, or the like that, if not correctly performed or adhered to, could result in personal injury or death. Do not proceed beyond a **WARNING** notice until the indicated conditions are fully understood and met.



Quick Start Guide

This *Quick Start Guide* helps you in preparing the signal generator for use. With this guide, you will become familiar with its basic operation and programming information. For more information, please refer to *User's Guide* from: www.agilent.com/find/n9310a

N9310 Overview 4

Preparation for Use 7

Generating a Continuous Wave Signal 9

Generating a Step Sweep Signal 11

Generating a Modulated Signal 13

Some Help Hints 15

Remote Control 16

Contact Agilent Technologies 22

Factory Default Settings 23



Check the Shipment

After receiving the shipment, you should first check the shipment and your order list refer to the procedures below.

- ✓ Inspect the shipping container for damage.

Signs of damage may include a dented or torn shipping container or cushioning material that indicates signs of unusual stress or compacting.

- ✓ Carefully remove the contents from the shipping container and verify that your order is complete. Each signal generator includes the following items as standard:

Item	Quantity	Part Number
N9310A signal generator	1	N9310A
USB cable	1	8121-1482
three-pin power cord	1	Specific to location
Quick Start Guide	1	N9310-90003
User's Guide	1	N9310-90001
Help kit CD-ROM	1	N9310-84500
Calibration certificate	1	N/A

- ✓ Verify if the ordered options are included in the shipment by checking the serial number on the rear panel of the signal generator:

Option	Name	Part number
001	I/Q modulator	N9310A-001
1CM	Rackmount flange kit	N9310A-1CM
1TC	Hard transit case	N9310A-1TC

Any question about your shipment, please contact Agilent Technologies Customer Contact Center for consulting and service.

Safety Notice

Please read the following warnings and cautions carefully before you power on the signal generator to ensure your personal and instrumental safety.

WARNING

Always use a well-grounded, three-pin AC plug and power cord to connect to a power source. Personal injury may occur if there is any interruption of the AC power cord of the signal generator. Intentional interruption is prohibited.

WARNING

Personal injury may result if the signal generator covers are removed. There are no operator serviceable parts inside. To avoid electrical shock, refer servicing to qualified personnel.

WARNING

Electrical shock may result if the signal generator is connected from the power supply while cleaning. Do not attempt to clean internally.

CAUTION

To install the signal generators in other racks, note that they may promote shock hazards, overheating, dusting contamination, and inferior system performance. Consult your Agilent customer engineer about installation, warranty, and support details.

CAUTION

Damage to the signal generator may result when the total power dissipated in the cabinet is greater than 800 watts. When this condition exists, forced convection must be applied.

CAUTION

The RF OUT connector is for signal output only. Avoid manually adding any external signal into the signal generator via this connector. This connector endures maximum +36 dBm RF power or 30 V DC input (1 minute lasting). Or it may result in instrument damages.

N9310 Overview

An Agilent N9310A RF Signal Generator finds general purpose test application between 9 kHz to 3 GHz. It is capable to generate variables of signals as shown below, which could be applied in the field of manufacture, service and repair, development and education:

- Continuous wave (CW) signal
- Low frequency (LF) signal
- RF/LF/Amplitude step sweep
- Amplitude modulation (AM) signal
- Frequency modulation (FM) signal
- Phase modulation (Φ M) signal
- Pulse modulation signal

The signal generator comprises an optional broadband I/Q modulator (option 001). With this option, N9310A is capable of generating complicated digital signal widely used in modern digital communication system in conjunction with an external I/Q signal generator.

The N9310A RF Signal Generator has USB connectors for your remote control and fast file transferring.



The Front Panel at a Glance

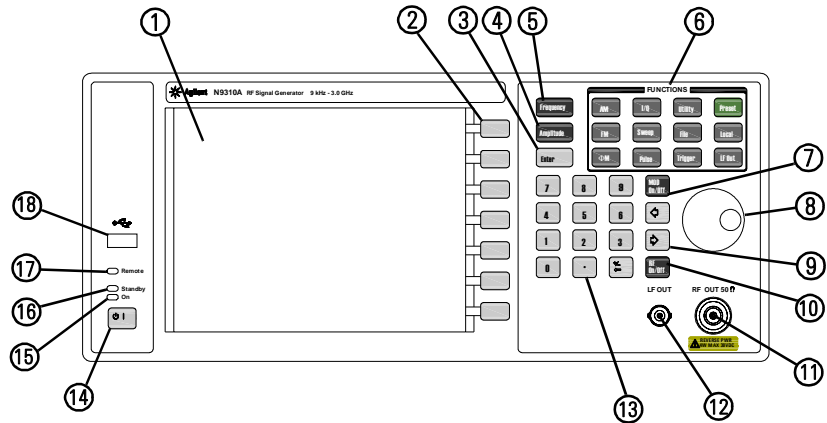

- | | | | |
|----------|---------------------------|-----------|-----------------------------|
| 1 | Screen | 10 | RF On/Off hardkey |
| 2 | Softkeys | 11 | RF OUT connector |
| 3 | Enter key | 12 | LF OUT connector |
| 4 | Amplitude hardkey | 13 | Numeric keypad |
| 5 | Frequency hardkey | 14 | Standby switch |
| 6 | Function hardkeys | 15 | Switch On LED |
| 7 | Mod On/Off hardkey | 16 | Standby LED |
| 8 | Knob | 17 | Remote LED |
| 9 | Arrow hardkeys | 18 | USB Device connector |

The Rear Panel at a Glance

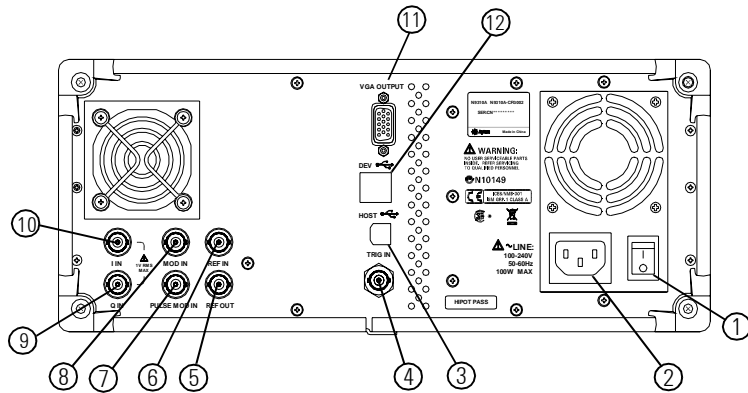

- | | |
|-------------------------------------|--|
| 1 AC power switch | 7 Pulse input connector |
| 2 AC power connector | 8 Modulation source input connector |
| 3 USB host connector | 9 Q input connector |
| 4 Trigger input connector | 10 I input connector |
| 5 Reference output connector | 11 VGA connector |
| 6 Reference input connector | 12 USB device connectors |

The signal generator rear panel provides input, output, and remote interface connections. Refer to “Rear Panel Overview” on *User’s Guide* for more information.

Preparation for Use

- 1 Connect the power cord. Insert the plug into a power socket provided with a protective earth. Set the tilt adjustor for your preference.

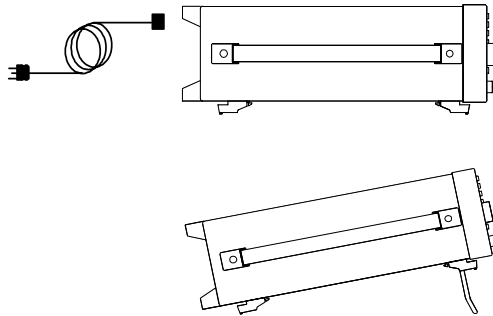

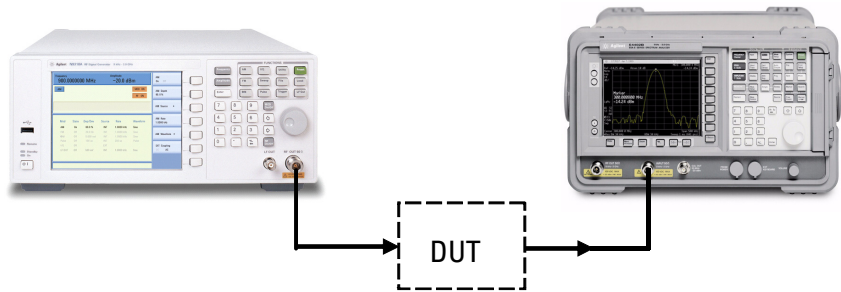

- 2 Connect an RF cable to the output connector of the signal generator and then connect the cable to your DUT (device under test) or other instrument.



Turn On the Signal Generator

Follow this procedure to power on the signal generator:

- 1 Press the power switch  on the rear panel. The orange LED will light and the signal generator is in standby mode.
- 2 Press the standby switch  on the front panel. The green LED will light.

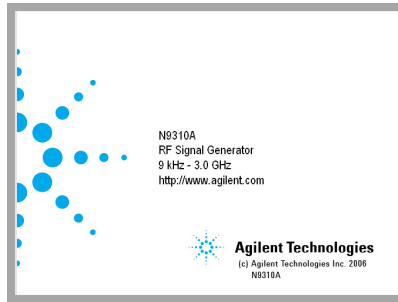

Self-initialization takes about 30 seconds; the signal generator then defaults to the menu mode with the maximum frequency of 3 GHz and minimum amplitude of -127 dBm, then the signal generator is ready for your current use. After power on, let the signal generator warm up for 45 minutes for stabilization.

NOTE

The front panel switch is a standby switch only; it is not a power switch. To disconnect the signal generator from the line power, shut off the power switch on the rear panel.

Generating a Continuous Wave Signal

To simplify the example, assume you wish to generate a continuous wave (CW) signal with a:

- Frequency of 1 GHz
- Power level of -20.0 dBm



Setting up Frequency

Operation	Notes
1. Press Preset hardkey	Sets the signal generator to its factory-defined instrument state.
2. Press Frequency hardkey	Frequency becomes the active function in the data entry area. This area displays the factory preset frequency.
3. Enter 1 using the numeric keypad and press GHz softkey	The FREQUENCY area and the active entry area both display the new carrier frequency (1.0000000000 GHz).

Setting up Amplitude

Operation	Notes
1. Press Amplitude hardkey	Frequency becomes the active function in the data entry area. This area displays the factory preset frequency.
2. Enter -20 using the numeric keypad and press dBm softkey	The AMPLITUDE area and the active entry area display the new level (-20.0 dBm).

Enable RF Output

Operation	Notes
Press  hardkey	Notice that the display annunciator changes from  to  . The CW signal is now available at the RF OUT connector.

The screen looks like this:



Generating a Step Sweep Signal





To simplify the example, assume you wish to generate a RF sweep signal with the characteristics of:

- Frequency range from 1 to 2 GHz
- 10 step point
- Dwell time of 500 ms for each step

Setting up a Step Sweep

Operation	Notes
1. Press Preset hardkey	Sets the signal generator to its factory-defined instrument state.
2. Press Sweep hardkey	Enables the submenu of sweep softkeys.
3. Press Step Sweep softkey	Enables the submenu of sweep settings.
4. Press RF Start > 1 > GHz	Sets the step sweep start frequency to 1 GHz.
5. Press RF Stop > 2 > GHz	Sets the step sweep stop frequency to 2 GHz.
6. Press #Points > 10 > Enter	Sets the step point to 10 in the step sweep.
7. Press More>Step Dwell>500>ms	Sets the dwell time to 500 ms for each point in the step sweep.

Enable RF Sweep

Operation	Notes
1. Press  hardkey	Turn on the RF OUT connector. Notice that the display annunciator changes from  to  .
2. Press Return>Sweep Mode	Displays another menu allowing you to choose the sweep mode
3. Press RF softkey	The  indicates sweep on, signifying that the sweep mode is enabled. The sweep signal is now available at the RF OUT connector.

Generating a Modulated Signal

To simplify the example, assume you wish to generate an amplitude modulated (AM) signal with a:

- Carrier frequency of 900 MHz
- Carrier power level of -20.0 dBm
- AM depth of 60%



Setting up carrier frequency and amplitude

Operation	Notes
1. Press Preset hardkey.	Sets the signal generator to its factory-defined instrument state.
2. Press Frequency > 900 > MHz	Sets the carrier frequency to 900 MHz for amplitude modulation.
3. Press Amplitude > -20 > dBm	Sets the carrier amplitude to -20 dBm for amplitude modulation.



Setting up Amplitude Modulation

Operation	Notes
1. Press AM hardkey.	Displays the AM first level menu.
2. Press AM Depth > 60 > %	Set the AM depth to 60%.
3. Press AM On Off softkey.	AM toggles from Off to On . The AM indicates “On” signifying that you have enabled amplitude modulation.

Enable Amplitude Modulation

Operation	Notes
Press  hardkey.	The display annunciator changes from  to  . The AM signal is now available at RF OUT connector.

NOTE

After pressing  hardkey,  will display on the screen which indicates the modulation is active. If you ignore this procedure, you need to press  hardkey to enable the modulator.

Then the screen displays like this:



Refer to *User's Guide* for more information.

Some Help Hints

Refer to the following hints to set the signal generator to your required setting:

- Set the screen saver on by pressing **Utility** > **Screen Saver**> **On**
- Select a display style by pressing **Utility** > **Display Style**
- Toggle the phase noise mode by pressing **Utility** > **Opti. Φ Noise**> **Normal/ResFM Opt.**
- Save the current configures for your frequent use to either local memory or an external USB memory by pressing **File** > **Save**
- Connect and set an external reference by pressing **Utility** > **Ref Setups**
- Connect an external display monitor to the VGA connector for the education projects or other needs.

NOTE

The calibration cycle of N9310A RF Signal Generator is one year.

NOTE

A button cell provides power to the real time clock of the signal generator. It is not rechargeable. If you find your N9310A encounters a clock defect, please contact your nearest Agilent Customer Contact Center (CCC) for service.

Remote Control

The N9310A signal generator provides USB connection to your PC, allowing you run your N9310A in remote mode.

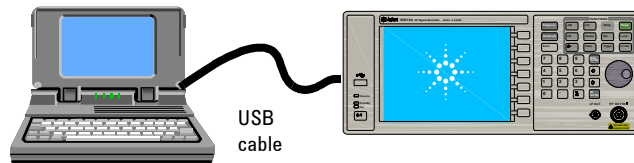

Before remotely control your N9310A, Make sure your PC meets the following minimum requirements:

- ✓ 450 MHz processor
- ✓ 128 MB RAM
- ✓ 175 MB available disk space
- ✓ Microsoft® Windows® 2000 SP4, XP SP2
- ✓ Display resolution: 800*600

NOTE

Pressing **Local** hardkey returns the signal generator from remote mode to local mode.

Installing Agilent IO Libraries suite

Before trying to remotely control your N9310A, you need to install **Agilent IO Libraries suite** on your PC. The **Agilent IO Libraries Suite** is a general purpose instrument driver for all Agilent test and measurement instruments. This software is in the documentation CD with the shipment, or download a latest version from

<http://www.agilent.com/find/iolib>

Follow the windows wizard to finish the installation. Then, you have successfully set up an environment for remotely control your N9310A.

Connecting your N9310A to a Controller

- 1 Switch on your N9310A. The orange standby LED on the front panel is turned off and the green LED is turned on.
- 2 Refer to the following graphic for your PC to instrument connection.

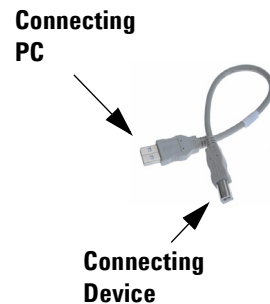
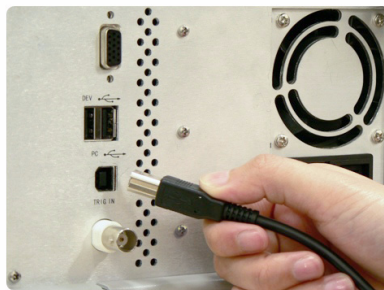

Then the signal generator is available for your remotely control. Any further information on programming please refer to *User's Guide*.

SCPI Command List

	SCPI Command	Utility
Frequency	:FREQuency:CW <val> <unit>	Set CW frequency
SCPI command	:FREQuency:CW?	
	:FREQuency:RF:STARt <val> <unit>	Set RF start frequency
	:FREQuency:RF:STARt?	
	:FREQuency:LF:STARt <val> <unit>	Set LF start frequency
	:FREQuency:LF:STARt?	
	:FREQuency:RF:STOP <val> <unit>	Set RF stop frequency
	:FREQuency:RF:STOP?	
	:FREQuency:LF:STOP <val> <unit>	Set LF stop frequency
	:FREQuency:LF:STOP?	
	:FREQuency:RF:SCALe LOG LIN	Set Sweep Scaling
	:FREQuency:RF:SCALe?	
Amplitude	:AMPLitude:CW <val> <unit>	Set CW frequency
SCPI command	:AMPLitude:CW?	
	:AMPLitude:STARt <val> <unit>	Set Start Amplitude
	:AMPLitude:STARt?	
	:AMPLitude:STOP <val> <unit>	Set Stop Amplitude
	:AMPLitude:STOP?	
Trigger	:TRIGger:IMMediate	Sweep immediately
SCPI command	:TRIGger:SSWP	Trigger a single sweep
Sweep	:SWEep:RF:STATe ON OFF 1 0	Turn On/Off RF Sweep
SCPI command	:SWEep:RF:STATe?	
	:SWEep:LF:STATe ON OFF 1 0	Turn On/Off LF Sweep
	:SWEep:LF:STATe?	
	:SWEep:AMPLitude:STATe ON OFF 1 0	Turn On/Off Ampl Sweep
	:SWEep:AMPLitude:STATe?	

SCPI Command	Utility
:SWEep:RF:START <val> <unit> :SWEep:RF:START?	Set RF start frequency
:SWEep:LF:START <val> <unit> :SWEep:LF:START?	Set LF start frequency
:SWEep:RF:STOP <val> <unit> :SWEep:RF:STOP?	Set RF stop frequency
:SWEep:LF:STOP <val> <unit> :SWEep:LF:STOP?	Set LF stop frequency
:SWEep:AMPLitude:START <val> <unit> :SWEep:AMPLitude:START?	Set start amplitude
:SWEep:AMPLitude:STOP <val> <unit> :SWEep:AMPLitude:STOP?	Set stop amplitude
:SWEep:STEP:POINTs <val> :SWEep:STEP:POINTs?	Set sweep point
:SWEep:STEP:DWELL <val> <unit> :SWEep:STEP:DWELL?	Set step dwell time
:SWEep:REPeat SINGLE CONTInuous :SWEep:REPeat?	Set sweep repeat
:SWEep:STRG IMMEDIATE EXT KEY :SWEep:STRG?	Set sweep trigger
:SWEep:STRG:SLOPe EXTN EXTP :SWEep:STRG:SLOPe?	Set sweep trigger slope
:SWEep:PTRG IMMEDIATE EXT KEY :SWEep:PTRG?	Set point trigger
:SWEep:PTRG:SLOPe EXTN EXTP :SWEep:PTRG:SLOPe?	Set point trigger slope
:SWEep:DIRection UP DOWN :SWEep:DIRection?	Set sweep direction
AM SCPI command	:AM:STATE ON OFF 1 0 :AM:STATE?

	SCPI Command	Utility
	:AM:DEPTh <val> :AM:DEPTh?	Set AM depth
	:AM:SOURce INT EXT INT+EXT :AM:SOURce?	Set AM source
	:AM:RATE <val> <unit> :AM:RATE?	Set AM rate
	:AM:EXTCoupling AC DC :AM:EXTCoupling?	Set external coupling
FM SCPI command	:FM:STATe ON OFF 1 0 :FM:STATe?	Turn on/off FM
	:FM:DEVIation <val> <unit> :FM:DEVIation?	Set FM deviation
	:FM:SOURce INT EXT INT+EXT :FM:SOURce?	Set FM source
	:FM:RATE <val> <unit> :FM:RATE?	Set FM rate
	:FM:EXTCoupling AC DC :FM:EXTCoupling?	Set external coupling
ΦM SCPI command	:PM:STATe ON OFF 1 0 :PM:STATe?	Turn on/off ΦM
	:PM:DEVIation <val> <unit> :PM:DEVIation?	Set ΦM deviation
	:PM:RATE <val> <unit> :PM:RATE?	Set ΦM rate
Pulse SCPI command	:PULM:STATe ON OFF 1 0 :PULM:STATe?	Turn on/off pulse
	:PULM:SOURce INT EXT :PULM:SOURce?	Set pulse source
	:PULM:PERiod <val> <unit> :PULM:PERiod?	Set pulse period

	SCPI Command	Utility
	:PULM:WIDTh <val> <unit> :PULM:WIDTh?	Set pulse width
I/Q modulation SCPI command	:IQ:STATe ON OFF 1 0 :IQ:STATe?	Turn On/Off I/Q modulation
LF Out SCPI command	:LFOutput:STATe ON OFF 1 0 :LFOutput:STATe?	Turn on/off LF output
	:LFOutput:FREQuency <val> <unit> :LFOutput:FREQuency?	Set LF frequency
	:LFOutput:AMPLitude <val> <unit> :LFOutput:AMPLitude?	Set LF amplitude
System SCPI command	:SYSTem:DISPlay WHITE BLUE GREEN :SYSTem:DISPlay?	Set display style
	:SYSTem:SSAVer ON OFF 1 0 :SYSTem:SSAVer?	Set screen saver
	:SYSTem:ERRor?	View error messages
	:SYSTem:DATE <year><month><day> :SYSTem:DATE?	Set system date
	:SYSTem:TIME <hour><minute> :SYSTem:TIME?	Set system time
	:SYSTem:REFerence:FREQuency INT10MHz EXT2MHz EXT5MHz EXT10MHz :SYSTem:REFerence:FREQuency?	Set external reference source
	:SYSTem:PNMD NORMal RESFM :SYSTem:PNMD?	Set phase noise mode
Modulation SCPI command	:MOD:STATe ON OFF 1 0 :MOD:STATe?	Turn on/off modulation
RF OUT SCPI command	:RFOutput:STATe ON OFF 1 0 :RFOutput:STATe?	Turn on/off RF output

Contact Agilent Technologies

Agilent Technologies has offices around the world to provide you with complete support for your signal generator. To obtain servicing information or to order replacement parts, contact the Agilent Technologies customer contact center listed below. In any correspondence or telephone conversations, refer to your signal generator by its product number and full serial number.

Press  > **Information** to find those information.

Online assistance: <http://www.agilent.com/find/assist>

United States

(tel) 800 829 4444
(fax) 800 829 4433

Canada

(tel) 877 894 4414
(fax) 800 746 4866

China

(tel) 800 810 0189
(fax) 800 820 2816

Europe

(tel) +31 20 547 2111

Japan

(tel) +81 426 56 7832
(fax) +81 426 56 7840

Korea

(tel) 080 769 0800
(fax) 080 769 0900

Latin America

(tel) +1 (305) 269 7500

Taiwan

(tel) 0800 047 866
(fax) 0800 286 331

Australia

(tel) 1 800 629 485
(fax) +61 (3) 9210 5947

Other Asia Pacific Countries

(tel) +65 6375 8100

(fax) +65 6755 0042

Email: tm_ap@agilent.com

Factory Default Settings

Item	Default	Item	Default
Frequency	3.000 000 0000 GHz	Sweep Scaling	Linear
Amplitude	-127.0 dBm	Sweep/Point Trigger	Immediate
LF Out	Off	Sweep Direction	Up
LF Out Freq	1.0000 kHz	Trig In Polarity	Negative
LF Out Ampl	500 mV	Modulation	
Mod On/Off	On	Modulation State	Off
RF On/Off	Off	AM Depth	0.0 %
Sweep		ΦM Deviation	0.000 rad
Sweep Mode	Off	FM Deviation	20 Hz
RF Start	9.0000 kHz	Pulse Period	200 μs
RF Stop	3.000 000 0000 GHz	Pulse Width	100 μs
Ampl Start	-127.0 dBm	Modulation Source	INT
Ampl Stop	-126.0 dBm	Modulation Rate	1.0000 kHz
LF Start	20.0 Hz	Ext Coupling	AC
LF Stop	80.0000 kHz	System	
#Point	10	Catalog	Local
Step Dwell	10.0 ms	Φ Noise Mode	Normal
Sweep Repeat	Cont	Reference Source	Int_10MHz

www.agilent.com

© Agilent Technologies, Inc. 2006

Printed in China

June 2006



N9310-90003



Agilent Technologies